



# Catalogue

## 2024 Edition

Servicing the maritime industry since 1978

- Safety
- Electrical
- Control
- Navigation
- Communications
- Plumbing
- Mooring
- Maintenance



Darwin

Cairns





## ABOUT NAUTICAL SUPPLIES

Nautical Supplies (AMI Maritime Pty Ltd Trading as Nautical Supplies) is a long established specialist supplier for Northern Australia's commercial, industrial and private marine sectors. Our Ship Chandleries are located on the waterfront close to Darwin's CBD, and Cairns Marine Industry Precinct in Portsmith.

We provide a broad range of goods and services, including marine safety equipment and electro-mechanical servicing, and have accumulated a wealth of knowledge and skills in supplying and servicing of this equipment.

In addition, at our Darwin location we have a sail loft and a rigging and splicing department.

We source leading international marine brands, and have freight services in place which enable us to provide fast and efficient deliveries across the whole of Australia and South East Asia. Nautical Supplies are a member of the AMI Group.

Follow us for new products and latest news   

## CONTACT US:

### NAUTICAL SUPPLIES DARWIN

80 Frances Bay Drive, Darwin, NT, 0800

Ph: 08 8981 6651

Email: [sales@nauticalsupplies.com.au](mailto:sales@nauticalsupplies.com.au)

## MARINE SAFETY

We have a special interest in the supply and service of marine safety equipment including life rafts (hire is also now available), inflatable life jackets, flotation and buoyancy devices, water activated lights, EPIRBs, flares, etc. This interest is fully supported by qualified staff and accredited premises.

## MARINE ELECTRONICS

Nautical Supplies supply, service and install a range of marine electronics for leisure, commercial and defence application including; radio systems, satcom, navigation equipment, IMCOS, and gas and fire detection systems.

## SAILING AND SPECIALTY SERVICES

In addition to our liferaft service facility we have a sail loft and workshop where we design, make and repair sails & related items. Our rigging workshop provides swaging and splicing services.



**SAFETY**

EPIRBs	4
PLB	5
SART & Horns	6
Flares and Distress Signals	7
Life Jackets	7-8
Life Rafts	9-10
Life Rafts for Hire	11
Rescue Boats and Tenders	12

**COMMAND & CONTROL**

Control Cables – Glendinning	13
EPROPULSION – Electric Outboards	14
Bow & Stern Thruster – Sleipner	15
Stabiliser Vector Fin – Sleipner	16
Interceptors/ Trim Tabs – Zipwake	17
Zipwake Interceptors – S Series	18
Zipwake Interceptors – E Series	19

**COMMUNICATIONS**

Antennas	20-21
Radio	22

**ELECTRICAL**

Navigation Lights	23
-------------------	----

**MAINTENANCE**

Anodes	24
Cosmetic Maintenance	25
Fuel Maintenance	26
Sealants and Adhesives	27

**MARINE ELECTRONICS**

Commercial Autopilots	28
Echo Sounders & Fish Finders	28
Marine Radar	29-30
Voice and Data	31

**MOORING & ANCHORING**

Anchors	32
Anchor Winches – MUIR	33
Buoys and Fenders	34
Chain and Swivels	35
Rope	36

**NAVIGATION**

Electronic Charts & Navigation Tools	37
--------------------------------------	----

**PLUMBING**

Pumps	38
-------	----



**Don't see what you need?**

Huge range available instore and online, contact us to discuss your requirements.



# EMERGENCY POSITION-INDICATING RADIO-BEACON (EPIRBS)

Should the unexpected happen, this EPIRB will relay your location to a vast network of search and rescue satellites, allowing local first responders to get you home more easily. Ensure your DCV meets float free EPIRB legislative compliance as of January 2021.

## ACR ARTEX



Designed with high-efficiency electronics that are built for performance, the GlobalFix™ V4 GP Emergency Position-Indicating Radio Beacon or EPIRB provides the protection you can trust in an emergency.

NS CODE	DESCRIPTION
A10722	EPIRB FLOAT FREE ACR GLOBAL FIX V4CAT1
A10773	EPIRB ACR 406 GLOBAL FIX PRO CAT 2



Available with and without automatic release bracket



## GME



The MT600G features a 66 channel GPS receiver with top mounted Quad helix antenna, which means locating the beacon is faster and more accurate.

NS CODE	DESCRIPTION
A10720	EPIRB FLOAT FREE GME MT603FGAUS CAT 1
A10774	EPIRB GME Mt600g (MANUAL) GPS 10YR BATTERY



Float free



Manual

## OCEAN SIGNAL



This Electronic Position Indicating Radio Beacon (EPIRB) will help make sure you're located & rescued if things go wrong.

NS CODE	DESCRIPTION
A10791	EPIRB FLOAT FREE OCEAN SIGNAL CAT1 PRO
A10790	EPIRB 406 RESCUEME 66CH GPS 10YR BATTERY



Float free model

For emergency situations where a user is not physically able to reach the EPIRB in time. The EPIRB1 Pro also comes complete with a Category I Automatic Release Housing.

## JOTRON



Jotron's high quality products conform to current international regulations according to IMO and SOLAS and meet any mandatory demands of the commercial, marine, fishing, offshore & leisure vessels.

NS CODE	DESCRIPTION
A10730	EPIRB FLOAT FREE JOTRON 60S GPS
Z65504	EPIRB JOTRON GPS MANUAL 60S



Manual



Float free

Tron 60S with float-free bracket has a small and compact handheld size. Tron 60S is totally sealed, has 5 years warranty and is designed to meet IMO SOLAS requirements.

## PERSONAL LOCATION BEACONS (PLB)

PLBs are smaller and easier to transport than other beacons, and are designed to be worn or carried by individuals rather than vehicles. PLBs do not always meet carriage requirements for maritime vessels travelling more than 2 nautical miles from the coast.

### ACR ARTEX



Small but resilient, the ResQLink 400 has been professionally engineered and tested to ensure it can withstand even the harshest elements.

NS CODE	DESCRIPTION
A10771	PLB RESQLINK PLB-400 GPS ACR



With three levels of integrated signal technology – GPS positioning, a powerful 406 MHz signal, and 121.5 MHz homing capability – the ResQLink 400 quickly and accurately relays your position to a worldwide network of search and rescue satellites.

### OCEAN SIGNAL



The RescueMe PLB1 can be operated with a single hand in even the most challenging situations. A simple spring loaded flap covers the activation button preventing inadvertent use.

NS CODE	DESCRIPTION
Z65130	PLB RESCUEME OCEAN SIGNAL
A10779	PERSONAL LOCATOR RESCUEME MOB1 AIS OCEAN SIGNAL



RescueME PLB1 works with the only officially recognised worldwide dedicated search & rescue satellite network (operated by Cospas Sarsat). As this is funded by governments there are **NO CHARGES** to use this service.

## HYDROSTATIC RELEASE UNITS

### HAMMAR



The Hydrostatic Release Unit (HRU) is designed and approved to automatically deploy a life raft or EPIRB in the event of a vessel sinking. HRUs operate between 1.5 and 4 metres of water depth, to release the securing mechanism for the life raft or EPIRB.

NS CODE	DESCRIPTION
A11215	HYDROSTATIC RELEASE HAMMAR H20
Z62728	HYDROSTATIC RELEASE TO SUIT OCEAN SIGNAL CAT1 PRI
A10825	HYDROSTATIC RELEASE TO SUIT ACR GLOBAL FIX V4CAT1
A11222	HYDROSTATIC RELEASE TO SUIT JOTRON 60S FLOAT FREE
Z65585	HYDROSTATIC RELEASE TO SUIT GME MT603FGAUS CAT 1

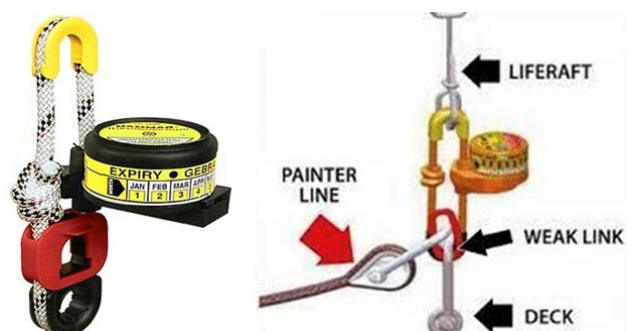
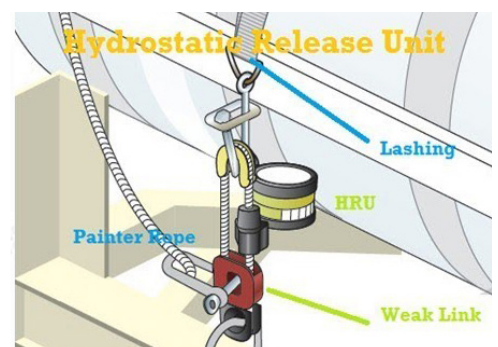

## SEARCH & RESCUE TRANSPONDER (SART)

SART or Search and Rescue Transponder is extremely vital equipment on the ship as it performs the job of a signal-man. It is a vital machine during distress for it helps in locating the position of the vessel in case it goes off-track. SARTs are made of waterproof components which protects them against damage by water.

### JOTRON



Tron AIS-SART GMDSS search and rescue transmitter is "Wheel Marked" in accordance with European Council Directive 96/98/EC with latest Commission Directive 2011/75/EU (7<sup>th</sup> amendment).

NS CODE	DESCRIPTION
A10850	SART TRON 20 W/ BRACKET JOTRON RESCUE ACR 2914



### ACR ARTEX



This SART complies with IMO SOLAS regulations, and has a superior lithium battery that provides over 96 hours of operating life in standby mode, and 12 hours of active operating life.

NS CODE	DESCRIPTION
A10830	SART PATHFINDER SEARCH AND RESCUE ACR 2914



## APPROVED SIGNALLING HORNS

### MARCO S.P.A



Electronic, with loudspeaker, control unit, acoustic membrane with ultrasonic heating system and remote control panel (EW series). Available approvals: RINA, LLOYD'S REGISTER MCA, BUREAU VERITAS, NMMA and BSH according to international regulations COLREG 1972 IMO classes III e IV.

NS CODE	DESCRIPTION
A64000	HORN EM1 MARCO LONG SINGLE SS 12V
A64002	HORN EM1 MARCO LONG SINGLE SS 24V
A64005	HORN TRUMPET EM1/2 SS 24V
A64022	HORN MARCO PW2 12/20M CW COMPRESSOR



## HAND HELD AIR HORNS

### MARCO S.P.A



Gas horn with snap connection. Complete with monobloc aluminium cylinder. Ecological flammable gas 200 ml.

NS CODE	DESCRIPTION
A11675	AIRHORN HAND HELD NON-FLAMMABLE

### RWB MARINE



Ecoblast is a rechargeable air horn - just pump in new air with a bicycle hand pump, a compressor, or at your local service station.

NS CODE	DESCRIPTION
A11670	AIRHORN ECOBLAST WITH PUMP



## FLARES & DISTRESS SIGNALS

### WESCOM GROUP



For emergencies at sea, flares are vital equipment to have on board to ensure visibility day or night. Visit the marine safety authority for your state for more information mandatory requirements.

NS CODE	DESCRIPTION
A11000	FLARE KIT COASTAL PACK (20+2R)
A11010	PARACHUTE ROCKET FLARE RED MK8
A11020	HANDFLARE RED PINPOINT MK8
A11050	HANDSMOKE FLARE ORANGE
A11090	LIFESMOKE BUOYANT ORANGE 3 MIN
A11100	MOB P/WESSEX MK9 LIGHT+SMOKE MARKER
A11120	SPEEDLINE LTA PAINS WESSEX 50200
A11125	ROCKET 50080 TO SUIT SPEEDLINE
A11165	FLARE CONTAINER POLY SMALL
A11101	LIGHT REPLACEMENT FOR MOB MK9



## MOB DEVICES

### MAN OVERBOARD

SOLAS approved life rings with reflective tape.

NS CODE	DESCRIPTION
A10500	LIFEBUOY SOLAS 75CM 4KG
A10503	LIFEBUOY SOLAS 75CM 2.5KG
A10510	LINE THROWER FOR LIFEBUOY 30/M 250KG
W10301	RESCUE LINE AND QUOIT
A10482	REELSLING SOS FLOATATION MOB DEVICE



## PLASTIMO



MOB pole for crew-overboard visibility, provides 150 N buoyancy.

NS CODE	DESCRIPTION
A10480	DANBUOY MOB MARKER SELF INFLATING



## MARINE FLOATATION DEVICES

### LIFECELL



Trailerboat is the smallest Life Cell that is designed to fit on smaller boats and can be used in inland or offshore waters. The largest of all Life Cells the Crewman is primarily designed for commercial use.

NS CODE	DESCRIPTION
A10515	LIFE CELL TRAILER BOAT 2-4 PERSON
A10516	LIFE CELL CREWMAN COMMERCIAL



## RECOVERY DEVICES

### LADDERS



NS CODE	DESCRIPTION
N19008	PILOT LADDER 2.5M
N19003	PILOT LADDER 6M
N19005	PILOT LADDER 10M
A10485	RECOVERY LADDER SOS MARINE



## INFLATABLE LIFE JACKETS

### MSEA



Available in manual or automatic, and in various sizes, contact Nautical Supplies to discuss your life jacket requirements. Various options available for offshore racing, coastal boating, or commercial SOLAS requirements.

NS CODE	DESCRIPTION
A10025	LIFEJACKET INFLATABLE MSEA 150N MANUAL
A10026	LIFEJACKET INFLATABLE MSEA 150N AUTO
A10041	LIFEJACKET INFLATABLE MSEA CLASSIC CREWMAN 150N AUTO
A10143	LIFEJACKET SKOPELOS COASTAL 150N ADULT >40KG

NS CODE	DESCRIPTION
A10030	LIFEJACKET INFLATABLE WORKVEST HAMMAR AUTO
A10010	LIFEJACKET SOLAS 275N AUTO
A10150	LIFEJACKET COASTAL ISO 12402-3 150N
A10142	LIFEJACKET EVAL SOLAS APPROVED COMPACT JACKET 145N
A10060	LIFEJACKET MSEA PRO HELMSMAN 180N AUTO



MSEA Pro Helmsman  
180N Auto



Inflatable Wipe  
Clean Workvest



SKOPELOS  
COASTAL 150N  
ADULT >40KG



MSEA Classic  
Crewman  
Auto/Manual



MSEA 150N  
Auto/Manual



EVAL SOLAS  
Approved Compact  
Jacket 145N

## SOS MARINE RANGE AVAILABLE



## LIFE JACKET LIGHTS

### EVAL



The new lifejacket light introduced by EVAL, is equipped with alkaline batteries of 5-year lifetime and guarantees continuous operation for more than 8 hours.

NS CODE	DESCRIPTION
A10410	LIGHT LIFEJACKET SOLAS APPROVED



## LIFE BUOY LIGHTS

### DANIAMANT



Increase visibility during man overboard situations.

NS CODE	DESCRIPTION
A10530	LIGHT LIFEBOUY DANIAMANT L160
A10524	LIGHT LIFEBOUY DANIAMANT L170C
A10540	LIGHT LIFEBOUY DANIAMANT L90
A10550	BRACKET TO SUIT L90 LIGHT





*LIFE RAFTS IN AUSTRALIA ARE TYPICALLY CLASSIFIED BY HOW THEY ARE USED:*

## CRUISING LIFE RAFTS

Designed with leisure marine in mind, for boating and fishing in calm waters close to shore, these rafts are intended to be deployed for less than 24 hours – until help arrives.



## COASTAL/OFFSHORE LIFE RAFTS

Intended for use further from the coast, and typically feature a protective canopy and dual buoyancy tubes for greater performance in rough seas.

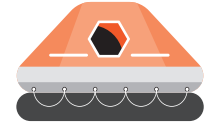

## SOLAS APPROVED LIFE RAFTS

Toughened for commercial vessels and defence application, and feature a large inventory of survival equipment and rations in event of extended exposure while awaiting rescue.

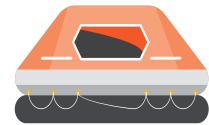

## SOLAS APPROVED COMMERCIAL LIFE RAFT

### DUARRY

Prestigious brand DUARRY is distributed and serviceable world-wide, with their life raft service station network being one of the most extended world-wide...

Available in NSCV, SOLAS Pack A or SOLAS Pack B configuration.

CAPACITY: 6-25 PERSON.

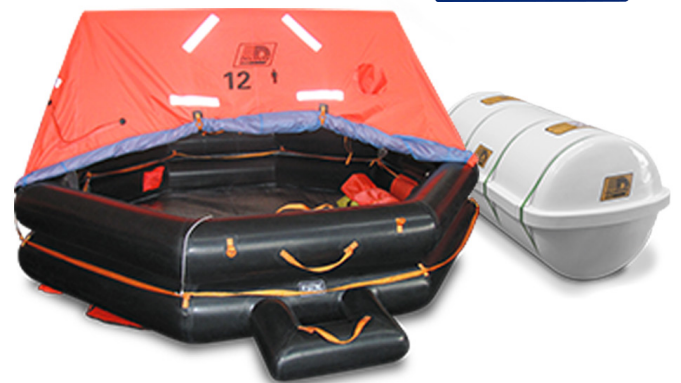

#### NS DESCRIPTION

LIFE RAFT DUARRY 6, 8, 10, 12, 16, 20, 25PL SOLAS A

LIFE RAFT DUARRY 6, 8, 10, 12, 16, 20, 25PL SOLAS B

LIFE RAFT DUARRY 30, 50, 65, 100, 150 PL (HSC-ORIL) OPEN REVERSIBLE

LIFE RAFT DUARRY 4, 6, 8, 10, 12 PL >24HR ISO DUARRY DYNAMIC

LIFE RAFT DUARRY 4, 6, 8, 10, 12 PL <24 HR ISO DUARRY DYNAMIC

## SOLAS APPROVED COMMERCIAL LIFE RAFT

### FUJIKURA

Using their state-of-the-art technologies cultivated by long experience in commercial maritime, Fujikura is engaged in production of inflatable life rafts, evacuation chutes, life jackets & lifeboats. Available in various packing options.



NS CODE	DESCRIPTION
W40006	LIFE RAFT SOLAS 6P FUJIKURA
W40010	LIFE RAFT SOLAS 10P FUJIKURA
W40015	LIFE RAFT SOLAS 15P FUJIKURA
W40020	LIFE RAFT SOLAS 20P FUJIKURA
W40125	LIFE RAFT SOLAS 25P FUJIKURA

# PLASTIMO TRANSOCEAN PLASTIMO

Designed for navigation in extreme conditions the Transocean includes a large capacity and quantity of ballast pockets, large area drogue anchors, -15°C inflation temperature (group A), double insulating floor, bright orange canopy with automatically erecting arch tube, 4.3 cd. outside light & retro reflecting stripes.

The Transocean ISO 9650-1 also features a ballasted reversible ladder and grab handle to ease embarking.

NS CODE	DESCRIPTION
W20160	LIFE RAFT NSCV 4P
W20170	LIFE RAFT NSCV 6P
W20180	LIFE RAFT NSCV 8P
W20190	LIFE RAFT NSCV 10P
W20192	LIFE RAFT NSCV 12P

ISO  
9650-1



6-man  
ISO 9650-1  
Transocean.

NEW  
**18-year**  
manufacturer's  
Warranty



## INCLUSIONS:

ITEMS INSIDE EQUIPMENT BAG	TRANSOCEAN ISO		
	< 24 H	> 24 H	COASTAL
SURVIVAL AND INSPECTION BOOKLET	1	1	1
AIDS TO SURVIVAL	1	1	1
RESCUE SIGNAL CARDS	1	1	1
SEA ANCHOR	1	1	1
KNIFE	1	1	1
RESCUE QUOIT AND LINE	1	1	1
BELLOWS	1	1	1
DISTRESS BEACON EPIRB	0	0	1
SIGNALLING TORCH	1	2	2
SPARE BATTERIES	2	4	4
SPARE BULB	1	2	2
PARACHUTE DISTRESS SIGNALS (SOLAS)	2	2	2
HAND FLARES (SOLAS)	3	6	6
BAILER	1	1	1
REPAIR KIT	1	1	1
PADDLES	2	2	2
SPONGES	2	2	2
WHISTLE	1	1	1
SIGNALLING MIRROR	1	1	1
THERMAL PROTECTIVE AIDS (SOLAS)	0	2	2
SEA SICKNESS PILLS PER PERSON	6	6	6
SEA SICKNESS BAG PER PERSON	1	1	1
FIRST AID KIT	0	1	1
WATER PER PERSON	0	1.5L	1.5L
FOOD RATION PER PERSON	0	500G	500G
RAINWATER COLLECTING POUCH	1	1	1
SUNSCREEN TUBE	0	2	2



# Hire a Life Raft

**BOATING SAFETY MADE EASY**

**Hiring or leasing with Nautical Supplies is easy, benefit from our competitive rates, flexible hire periods and hassle free servicing.**

Nautical Supplies offer a range of life rafts for recreational boating or professional use, from well known brands in marine safety.

**PLASTIMO**



**Fujikura**



**Hire a life raft with Nautical Supplies & maintenance is taken care of;**

We will arrange servicing by our qualified Technicians at manufacturer's recommended intervals to ensure safe operation of the raft at all times, ready for use in the event of an emergency.



## RIB TENDERS 2.4M+

### SWIFT TENDERS



Swift Tenders have a solid and sophisticated feel with their aluminium hull, wide beam and large diameter tubes. Stylish yet practical, they are light, stable, fun to use and are purpose built to travel safely from ship to shore fully loaded.

The standard hull is produced from the finest powder coated marine grade aluminium and has a flat floor with welded-in cast lifting & towing lugs. The tube fabric is coated with "ORCA" Hypalon, a synthetic rubber which is resistant to everything from sunlight and abrasion to petrol and even acetone solvent.



LENGTH WEIGHT	BEAM OVERALL	TUBE DIAM.	CHAMBERS		HP		PERSONS LOAD	
			NO.	MAX	MAX	KGS	KGS	
2.4	1.44	360	3	5	3	340	37	
2.6	1.55	400	3	8	4	430	42	
2.9	1.55	400	3	10	5	500	45	
3.1	1.55	400	3	15	6	550	49	

\*Contact us for larger models

\*Other brands also available

## NARWHAL SOLAS RESCUE VESSELS



As their main mission, these vessels have been designed for the recovery of crew members who fall into the sea, based on their ease of maneuvering and their rapid set-up. It is equally useful for an eventual abandonment or displacement of the ship and is also used to group, tow & organize life rafts.

The unsinkable rescue vessels NARWHAL SV-420 and SV-480 comply with S.O.L.A.S. regulations, as well as Directive 96/98 / EC, as amended by Directive 2002/75 / EC, on marine equipment (MED), with the CERTIFICATE OF APPROVAL MED-B-000004W for SV-420 and MED-B-000004X for SV-480.



SPECIFICATIONS	SV-420	SV-480
TOTAL LENGTH	420 CM	480 CM
INNER LENGTH	306 CM	354 CM
TOTAL BLANKET	207 CM	210 CM
INNER SLEEVE	123 CM	110 CM
MAXIMUM DEPTH	100 CM	100 CM
MAXIMUM DIAMETER	50 CM	51 CM
NUMBER OF COMPARTMENTS	5+1	5+1
AUTHORISED MOTORISATION	25 HP OR 40 HP	40/50/60 OR 75 HP
MOTOR SHAFT TYPE	L	L
MAXIMUM NUMBER OF PEOPLE	6	6
THREAD WEIGHT	200 KG.	250 KG.
MAXIMUM AUTHORISED LOAD	716 KG.	718 KG.

## FLEXIBLE, DURABLE CONTROL CABLES

### GLENDINNING



Glendinning's Pro-X™ control cables offer you a comprehensive line of high quality pull only, push pull, and specialty control cables. Pro-X™ control cables give you the quality and reliability you've been looking for! Glendinning believe in the best possible quality. From the conduit to end fittings, Pro-X™ control cables are manufactured consistently and professionally in Glendinning's facility.

NS CODE	DESCRIPTION
N16300	CONTROL CABLE 33C PRO-X 1.00M
N16304	CONTROL CABLE 33C PRO-X 1.50M
N16310	CONTROL CABLE 33C PRO-X 2.25M
N16312	CONTROL CABLE 33C PRO-X 2.50M
N16314	CONTROL CABLE 33C PRO-X 2.75M
N16316	CONTROL CABLE 33C PRO-X 3.00M
N16320	CONTROL CABLE 33C PRO-X 3.50M
N16323	CONTROL CABLE 33C PRO-X 3.75M
N16324	CONTROL CABLE 33C PRO-X 4.00M
N16326	CONTROL CABLE 33C PRO-X 4.25M
N16328	CONTROL CABLE 33C PRO-X 4.50M
N16334	CONTROL CABLE 33C PRO-X 5.25M
N16336	CONTROL CABLE 33C PRO-X 5.50M
N16340	CONTROL CABLE 33C PRO-X 6.00M
N16344	CONTROL CABLE 33C PRO-X 6.50M
N16348	CONTROL CABLE 33C PRO-X 7.00M
N16352	CONTROL CABLE 33C PRO-X 7.50M
N16354	CONTROL CABLE 33C PRO-X 7.75M
N16356	CONTROL CABLE 33C PRO-X 8.00M
N16358	CONTROL CABLE 33C PRO-X 8.25M
N16360	CONTROL CABLE 33C PRO-X 8.50M
N16364	CONTROL CABLE 33C PRO-X 9.00M
N16366	CONTROL CABLE 33C PRO-X 9.25M
N16368	CONTROL CABLE 33C PRO-X 9.50M
N16372	CONTROL CABLE 33C PRO-X 10.00M
N16376	CONTROL CABLE 33C PRO-X 10.50M
N16380	CONTROL CABLE 33C PRO-X 11.00M
N16400	CONTROL CABLE 33C PRO-X 13.50M
N16402	CONTROL CABLE 33C PRO-X 13.75M
N16404	CONTROL CABLE 33C PRO-X 14.00M
N16408	CONTROL CABLE 33C PRO-X 14.50M
N16412	CONTROL CABLE 33C PRO-X 15.00M
N16418	CONTROL CABLE 33C PRO-X 16.00M
N16426	CONTROL CABLE 33C PRO-X 17.50M
N16430	CONTROL CABLE 33C PRO-X 18.00M

#### Cable Applications:

- Throttle
- Choke
- Brake
- Utility
- Fuel Shutoff
- Emergency Steering
- Tension
- Flow Control
- Push Button
- Tachometer Core
- Remote Release

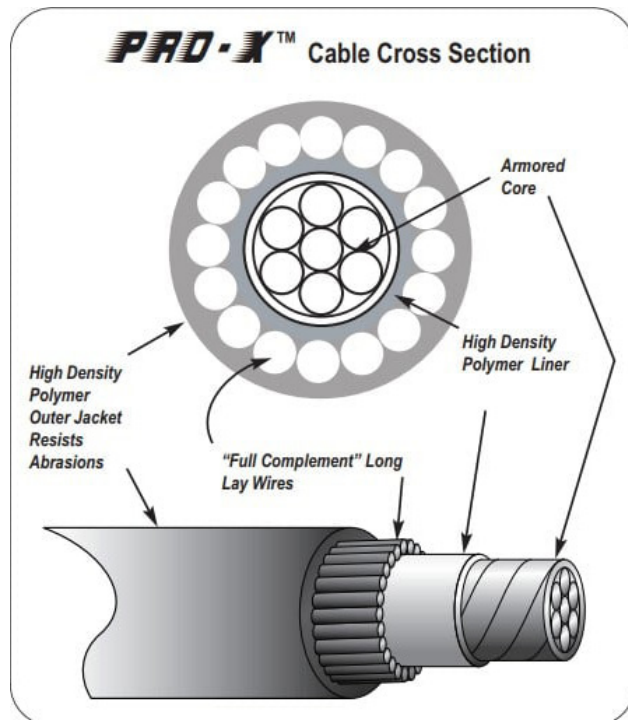

## ELECTRIC OUTBOARDS

### EPROPULSION

Leading Electric Boating

EPROPULSION is leading the market in electric outboard motors for small boats, in portable and long-range outboard motors with integrated battery and tiller control, or remote control.

Noise free, clean and green - an electric outboard motor that is perfect for cruising, fishing and other water activities.

1kW (~3HP) Models

SPIRIT 1.0 PLUS - Most Popular Model!

Also available with remote controller and hydro-generation - allowing recharge while leg is down, being towed underway

3kW (~6HP equivalent) Navy 3.0 Evo

Powerful 3kW electric outboard provides efficient and clean power for small vessels. Tiller or Remote controller and hydro-generation.

6kW (~10HP equivalent) Navy 6.0 Evo

Powerful 6kW electric outboard provides efficient and clean power for small vessels. Tiller or Remote controller and hydro-generation.

\*More powerful electric outboards available, as well as inboards.  
Enquire for details.





SLEIPNER

## THRUSTERS

### SLEIPNER

Built for outstanding performance, your time on the water will always be better with a Sleipner thruster onboard. With the world's most extensive thruster range, we can assure you will find the right fit for your boat.

Suitable for vessels 6 m to 46m (20 ft to 150 ft).

Sleipner was established in Norway in 1908 with more than 115 years of experience and a commitment to quality and product development it's clear why Sleipner range of thrusters are the industry benchmark.



### TUNNEL THRUSTERS

Sleipner's tunnel thrusters are the world's top-selling thrusters resulting from over 35 years of development. Over the years, their tunnel thrusters have been installed in more than 300,000 boats worldwide and are the preferred choice by most leading boat builders. With the world's largest selection of tunnel thrusters, there should be no compromise finding a good fit for your vessel. Sleipner's tunnel thrusters come in DC electric, AC electric, & Hydraulic. Suiting boats from 6m to 55m (20ft-175ft).



DC Electric

AC Electric  
Tunnel Thrusters

Hydraulic

### RETRACTABLE THRUSTERS

For sailboats, cruisers or flat-bottomed boats. Sleipner's retractable thrusters are designed with a focus on practical sturdiness, uncompromised safety, & quick deployment. Also suitable as stern thrusters on motorboats that cannot fit a tunnel or external stern thruster on the transom. Sleipner's retractable thrusters come in DC electric, AC electric, & Hydraulic. Suiting boats from 10m to 46m (35ft-150ft).

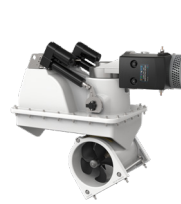

DC Electric

AC Electric  
Retractable Thrusters

Hydraulic

### EXTERNAL THRUSTERS

Sleipner's DC external thrusters are the most compact on the market, making it the perfect choice if you have a boat where the inside configuration does not fit a standard thruster installation. Its versatile design and compact size allow for installation on boats of any hull shape. Sleipner's DC external thrusters come in multiple different form factors. Suiting boats from 6m to 18m (20ft-59ft).



External DC Thrusters



### E-SERIES ELECTRIC TUNNEL THRUSTERS

Sleipner's new E-series thruster line incorporates a highly efficient, compact, quiet, and lightweight electric motor that rivals the most cutting-edge motors in today's automotive industry. Previous Sleipner thruster models can be upgraded with the new E-series electric motor either directly or by utilizing an adapter plate between the bracket & motor.

#### Benefits:

- Up to 50 percent lighter and smaller motor
- Ignition protected
- Integrated inverter for variable speed control
- Industry-leading runtimes
- Less noise
- More compact
- Splashproof
- Retrofit options
- Made in Norway

Please see here for the Sleipner thruster range:

<https://www.amisales.com.au/products/thruster-systems.html/>

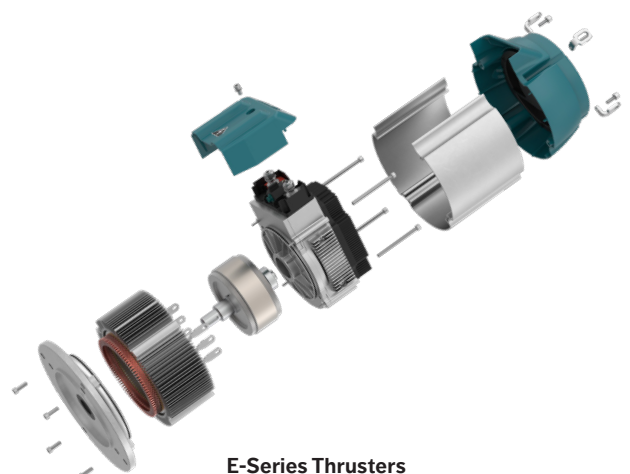

E-Series Thrusters



## STABILISER VECTOR FINS

### SLEIPNER

Superior stabilization in every situation. With ever more compact and efficient systems, boat owners can now enjoy the better usability and comfort on leisure vessels of all sizes.

Sleipner's Vector fins™ are the only top performing stabilizer system for both cruising and at anchor-use. The fins' patented, unique shape reduces drag and improves fuel efficiency – translating more of their power into actual roll stabilization. Enhanced comfort and safety with none of the drawbacks from flat fins. Sleipner's Vector fins™ are available in hydraulic & electric versions.

Rolling around at sea is something most people will prefer to avoid if they can. With the modern stabilizing systems available on the market today, they do reduce the risk of becoming seasick by 80-90 percent. Another aspect worth considering is plain and simple onboard safety. Let's forget about seasickness and general onboard comfort for a while. A roll of just a few degrees impacts your footing onboard. Unexpected swells catch you off guard and send objects flying around. We've all been there. A stabilized boat is a very different base in terms of both perceived and actual safety. Over the last few years, roll stabilization has become a must-have for boat owners due to the impressive increase in comfort it delivers. The dramatic roll reduction modern systems provide also increases safety on board and as a result, allows many families to get more use out of their boats.

### VECTOR FINS™ BENEFITS

- Up to 50% more efficient than flat fins
- Up to 55% less side effects than flat fins
- Advanced hydrodynamic fin design
- 20%-50% less resistance than other fins, results in virtually no loss of speed, therefore no added fuel consumption
- All fins are prepared for high efficiency in "Any Speed" – 2:1 size ratio, also "At Anchor"
- "One-shot" vacuum injected vinylester process
- Rowing and math layers to ensure maximum strength

### ELECTRIC VECTOR FINS™

The 3rd generation Vector Fins™ - more sustainable choice. The new Sleipner electric actuator solves the challenge of structural born noise from electric or electro-mechanic actuators. The patented solution isolates the moving, mechanical high-torque gears and motor from the boat reducing about 92% of structural born noise. Not only that, the third generation Vector Fins™ typically doubles the stabilizing force per kW input, compared to flat fins at anchor.

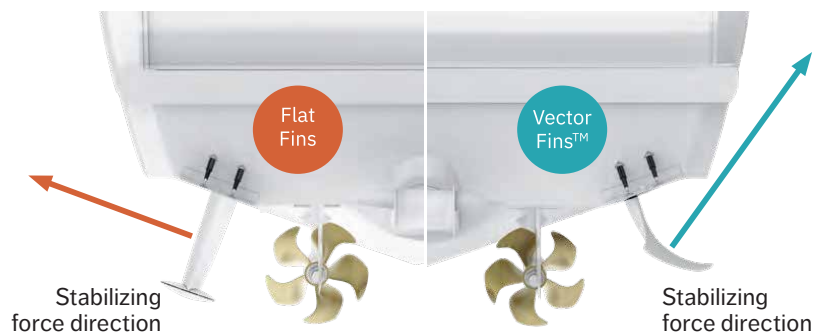
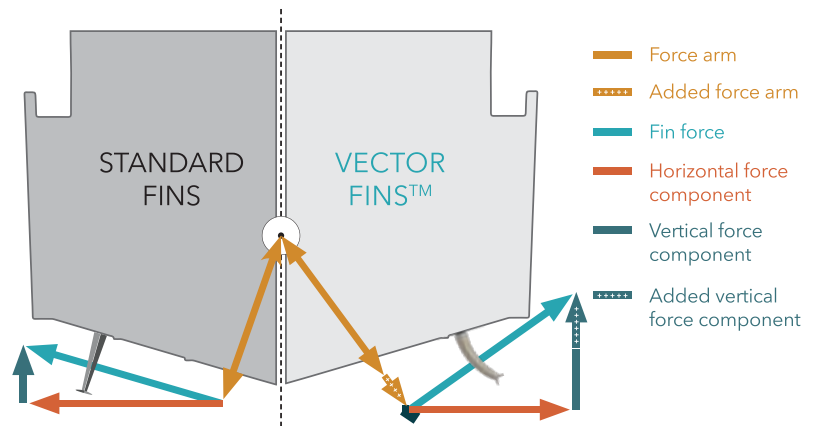

This simplified illustration shows how the Vector Fins™ better directs the fin forces toward the desired vertical direction, minimizing the energy waste of too many forces being used in the horizontal plane, which can cause unwanted side effects such as yaw and sway.

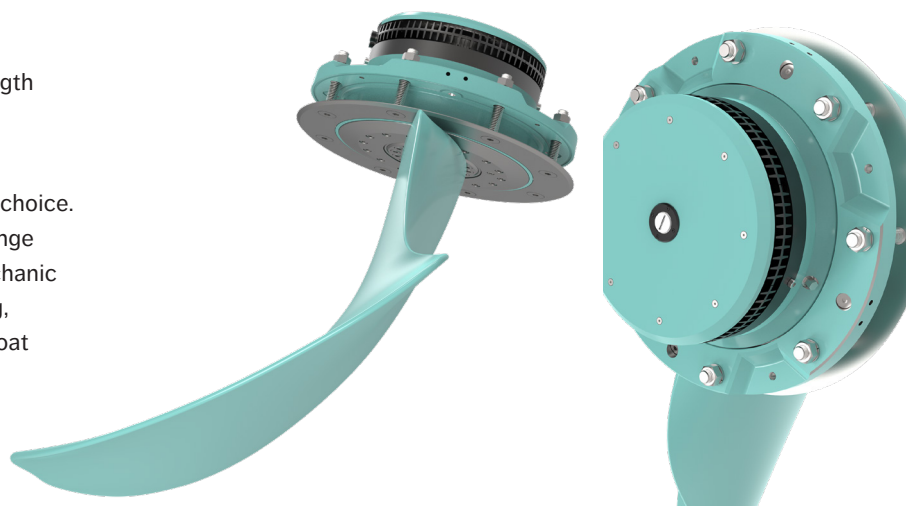



## INTERCEPTORS/TRIM TABS

### ZIPWAKE

Zipwake are the interceptors of tomorrow, say goodbye to trim tabs and to manual pitch and roll. Zipwake being the largest interceptor supplier in the world with over 50,000 systems sold and having also the widest range of interceptors available, 24 models/shapes/sizes; Zipwake is sure to have you covered, having not only an interceptor to fit your needs, but an interceptor that you can trust and rely on.

Zipwakes dynamic trim control system rid you of uncomfortable pitch and roll giving you higher performance, improved comfort, lower fuel consumption and enhanced safety...all of this done fully automatically.

### FEATURES INCLUDED IN EVERY MODEL:

- **AUTO PITCH**

Experience faster acceleration, extended planing speed range and improved visibility as you cruise on the water.

- **AUTO ROLL**

Auto Roll dynamically and automatically keeps your boat on an even keel – regardless of wind, load distribution or rough waves.

- **COORDINATED TURN**

Perfectly coordinated turns – every time. Whatever your speed, Zipwake automatically adjusts the heeling angle of your boat for a safer and more comfortable ride.

### INTEGRATOR MODULE

Seamlessly connect your Zipwake system to multifunctional displays (MFDs) and smart devices. The Integrator Module gives you intuitive, easy control and keeps your dashboard clean.

- Seamless integration to MFDs and smart devices.
- Clean Dashboard
- Easy to install – anywhere

### MINI CONTROLLER

Get all the beauty of a clean dashboard without sacrificing the user-friendliness of a control panel. The Mini Controller lets you operate your Zipwake trim control system without having to reach for an MFD.

With a Zipwake Dynamic Trim Control System, you'll enjoy intuitive and precise control of your boat's running trim, heel and heading. The system is fully automatic and significantly enhances the boat's performance, fuel economy, comfort and safety. It's almost like getting a brand new boat – in a box

# ZIPWAKE

CHOOSE COMFORT. ENJOY PERFORMANCE.

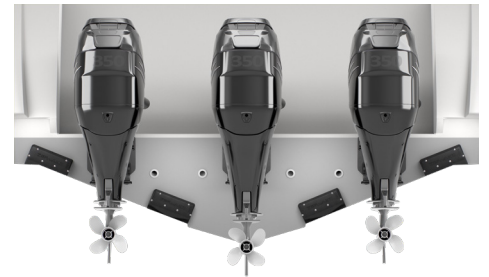

## INTERCEPTORS/TRIM TABS

### SERIES S - FOR BOATS UNDER 15M (50FT)

With four unique interceptor types, Zipwake provides maximum installation flexibility for a variety of hull shape and sizes.

Series S constitutes a product family of four straight, four V-shaped, four chine and one intermediate interceptors. This first-ever modular design made for mass production makes the interceptors durable, affordable and perfectly adapted to any planing or semi-planing boat between 6 m and 15 m (20-50ft).

All components have been meticulously engineered to withstand impact and avoid water ingress, minimizing the risk of costly maintenance and downtime.

Interceptor or blade actuation takes place by way of a calibration-free submersible electric servo within the interceptor unit. Its natural water cooling provides excellent working conditions for the brushless DC servo motor, which runs on 12-32 volts. The blade stroke takes 1.5 seconds, outperforming conventional trim tabs by at least a factor of 5.

Installation is made easy with an integral mounting plate and the option of a concealed or above-waterline, self-sealing, thru-hull cable fitting.

The preferred mounting option is achieved by simply routing the servo cable differently. Each interceptor comes with the thru-hull cable fitting, cable covers and a practical drill template.

### STRAIGHT

Straight interceptors come in a wide range of sizes including the following models IT300-S, IT450-S, IT600-S and IT750-S for modular use.

### INTERMEDIATE

When space between multiple outboards or sterndrives is tight, an intermediate interceptor offers a viable alternative for additional pitch & roll motion control not possible with a corresponding straight interceptor without degrading propeller performance.

### V-SHAPED

For centerline mounting these are perfect for filling the gap between twin outboards or sterndrives, as well as dual propeller tunnels. The four V-shaped models cover deadrise angles effectively between 11 to 24 degrees.

### CHINE

These provide a unique means of maximizing pitch and roll motion control by utilizing the furthest outboard surfaces of the hull bottom for lift generation. Thanks to its special blade shape, the intermediate interceptor generates a narrower trail in the water that mitigates propeller inflow disturbance, allowing even installation between outboards mounted at their minimum offset.

### ADAPTOR PLATES

With Zipwake Adaptor Plate Kits, boaters can easily upgrade to Zipwake from another similarly sized interceptor system. The plates streamline hull preparations to upgrade to Zipwake Series S, fitting perfectly to the existing transom screw hole pattern and sealing previous holes for thru hull fittings.

# ZIPWAKE

CHOOSE COMFORT. ENJOY PERFORMANCE.

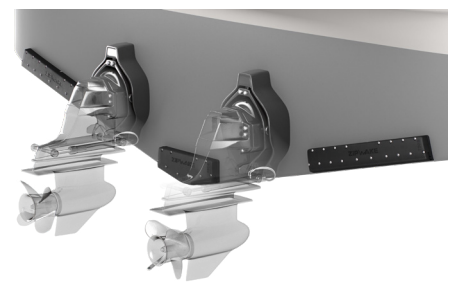

# INTERCEPTORS/TRIM TABS

## SERIES E - FOR BOATS UNDER 30M (100FT)

Zipwake Series E Ideal for bigger boats up to 30m (100 ft) Series E is a family of large, fast-acting interceptors that includes three straight, three tunnel and two chine models. Their blade rate and stroke are 40 mm/s and 60 mm respectively. The large, modular design made for mass production means the interceptors are durable, affordable and particularly well adapted to any planing or semi-planing boat between 12m and 30m (40ft to 100 ft).

### STRAIGHT

Straight interceptors come in a wide range of sizes including the following models IT400-E, IT600-E, IT800-E and IT1000-E for modular use.

### TUNNEL

Tunnel-shaped interceptors provide the perfect lift-force solution for hulls with propeller tunnels. In contrast to straight interceptors, the tunnel interceptor's constant radius curvature allows mounting above the propeller tunnel to fully or partially use the otherwise unutilized part of the beam for lift generation. The three tunnel models with different radii, R500, R600 and R800, make sure that most large boat propeller tunnels can be covered with negligible deviation between hull and interceptor curvature. Tunnel interceptors can be included in new installations, or retro-fitted to systems already installed.

### CHINE

These interceptors provide a unique means of maximizing pitch and roll motion control by utilizing the furthest outboard surfaces of the hull bottom for lift generation. As a rule, the lift effect of a chine interceptor matches the lift of a straight interceptor one size larger mounted inboard of the chine, making them the go-to choice when selecting interceptors. Chine interceptors are particularly useful when transom space is limited abeam of swim platform lifts, waterjets, surface drives, or outboards.

### FEATURES & BENEFITS:

- Price / Affordability / Scope of Supply
- Modular system – fits every transom
- Everything included from the start – A new boat in a box
- Fully Automatic Pitch and Roll Control
- No need for upgrades
- Auto- cleaning options.
- Upgradeable via USB stick or OTA (Over the air/Integrator Module)
- Installation friendly – Fast and Easy – Saves time in production
- Unique interceptor models e.g. the tunnel, intermediate, chine models
- Monitored and/or controlled OTA from external devices, e.g. multifunction displays or plotters via its NMEA 2000 interface
- Flexibility – possibilities to have more than 2 interceptors
- Handle de-acceleration well (no bow up, stay on plane as low as possible)
- Each interceptor comes with the thru-hull cable fitting, cable cover and a practical drill template.
- For best effect, different size interceptors can be combined to span as much of the transom edge as possible. A full beam is always the optimal arrangement from a lift-to-drag ratio point of view



CHOOSE COMFORT. ENJOY PERFORMANCE.



## AUSTRALIAN MADE ANTENNAS

### GME



GME's range of Australian Made marine VHF antennas lead the market in performance and quality. Designed, engineered, and manufactured to ensure reliability and high performance in the harshest marine environments. Compatible with GME's full range of marine VHF radios, these antennas are the perfect addition to any vessel's communication set up.

## COMPLETE VHF ANTENNA SOLUTIONS

1800mm Ground independent VHF antenna.

NS CODE	DESCRIPTION
TG4019	ANTENNA VHF GME AE346V 1.8M

## VHF WHIP ANTENNAS

White fibreglass ground independent antennas.

NS CODE	DESCRIPTION
TG4020	ANTENNA VHF GME AW364V 1.2M
TG4021	ANTENNA VHF GME AW366V 1.8M
TG4022	ANTENNA VHF GME AW368V 2.4M



AW364V 1.2M



AE346V

AE346V connection closeup



## COMMERCIAL QUALITY COMMUNICATION

### BANTEN



Italian made Bantén communication products are known for their reputation in the design and manufacture of commercial and professional grade antenna utilised by commercial maritime, leisure and defence vessels.

## TV ANTENNAS

This antenna is ideal for boats or caravans.

## VHF ANTENNAS

Range of Bantén antennas available, speak to your sales representative for full selection.

NS CODE	DESCRIPTION
1282090	TV DIGI WHIP 25CM WITH SPORTS CONNECTION
1280080	20306 RACING AIS VHF 162 MHZ 0.25M
1280204	00045 ANT VHF EMERGENCY 25CM ORANGE

Digi Whip Antenna kit includes 5m cable for installation



TV Digi Whip

Marine AIS - 0.25m (10") - S/S bracket - helical antenna - 0 dBi gain - PL connector



Racing AIS VHF

Antenna Specifically designed for the EMERGENCY Marine VHF 156.8 Mhz channel



Emergency 25cm

## QUALITY MARINE ANTENNAS GLOMEX



Established in 1984, Italian made Glomex antennas offer high quality manufacture and durability. Partnering with premium boat builders such as Azimut Benetti, Bavaria, Beneteau Jeanneau, Dufour yachts, Ferretti Group, Hanse, Sea Ray and Sunseeker, just to name a few.

### VHF ANTENNAS

VHF antennas for crisp & dependable radio communication.

NS CODE	DESCRIPTION
TG4013	VHF ANTENNA 3DB 900MMSTAINLESS STEEL FME TERMINATION GLOMEX P/N RA106SLSFME
TG4001	VHF ANTENNA 3DB 1.5M F/GLASS
TG4011	VHF ANTENNA HIGH PERFORMANCE 6DB 2.4M F/GLASS RA1225HP
TG4002	VHF ANTENNA 6DB 2.4M F/GLASS



### SAILBOAT ANTENNAS

35" Classic Stainless Steel VHF Sailboat Antenna with Bracket 3dB – PI-259 Connector, No Coax Cable Included.

NS CODE	DESCRIPTION
TG4012	VHF ANTENNA 3DB 900MM SS RA109SLS

### DECK MOUNT

NS CODE	DESCRIPTION
TG4009	DECK MOUNT 4 WAY RATCHET
TG4003	DECK MOUNT 4 WAY RATCHET STAINLESS STEEL

### HF ANTENNAS

NS CODE	DESCRIPTION
TG4005	HF ANTENNA 800W 7M 3 PIECES @ 2.35, 2.35 AND 2.3M F/GLASS PRA703
TG4006	HF ANTENNA 500W 4.73M @ 2 PIECES 2.4 AND 2.35M PRA702

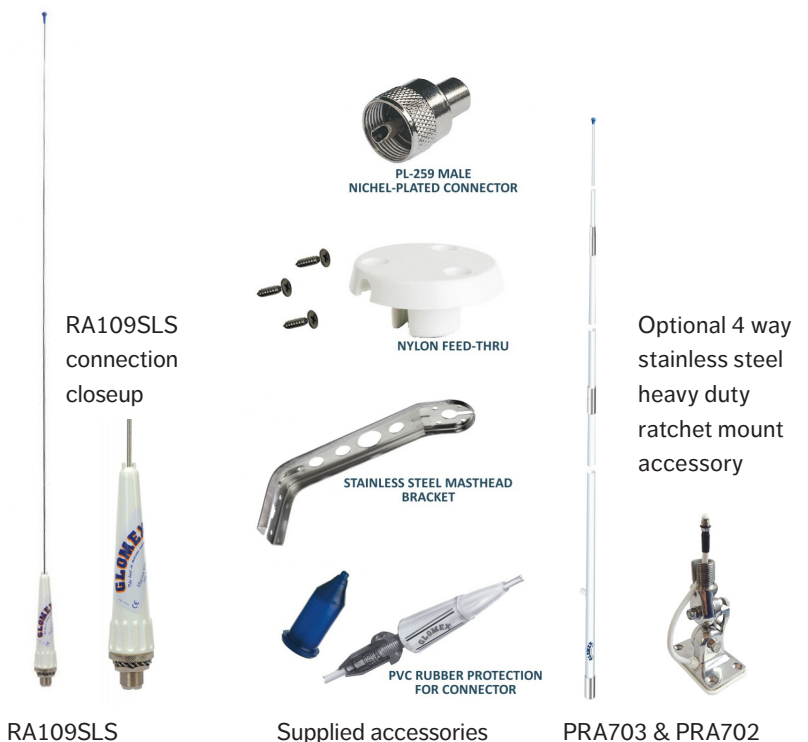

RA109SLS

Supplied accessories

PRA703 & PRA702

## MARITIME RADIO

### ICOM



A marine radio is one of the most important safety tools on board any vessel. Icom's range of VHF and HF marine transceiver offer innovations such as buoyancy, submersible construction, tough military design and AIS receive capabilities.

## HANDHELD VHF RADIO

NS CODE	DESCRIPTION
TG8325	VHF MARINE RADIO ICOM HH M25
TG8324	VHF MARINE RADIO ICOM HH M37E
TG8328	VHF MARINE RADIO ICOM HH M73 EURO
Z56207	VHF RADIO GMDSS HANDHELD IC-GM1600E



## HF RADIO

NS CODE	DESCRIPTION
TG8350	RADIO ICOM MARINE TRANSCEIVER MF/HF M804
TG3000	RADIO JRC MF/HF JSS-2150



## DASH MOUNT VHF RADIO

NS CODE	DESCRIPTION
TG8320	VHF MARINE RADIO ICOM IC-M200
TG8323	VHF MARINE RADIO ICOM IC-M330GE
TG8423	VHF MARINE RADIO ICOM IC-M423G
TG8424	VHF MARINE RADIO ICOM IC-510 E
TG8424	RADIO VHF MARINE ICOM IC-M510E AIS



## HANDHELD MICROPHONES

NS CODE	DESCRIPTION
TG8315	HAND MIC HM165 TO SUIT M34D
TG8326	HAND MIC HM213 TO SUIT M25 AND M37
TG8440	HAND MIC HM167 TO SUIT M73



## MOUNTING KITS

NS CODE	DESCRIPTION
TG8001	FLUSH MOUNTING KIT FOR ICOM RADIO MB69
TG8002	FLUSH MOUNTING KIT FOR ICOM RADIO MB132
TG8003	FLUSH MOUNTING KIT FOR ICOM RADIO MBF5



## CLASS B AIS TRANSPONDER

NS CODE	DESCRIPTION
Z65229	AIS CLASS B ICOM MA-510TR





# NAVIGATION LIGHTS

## HELLA MARINE

Through ongoing R&D, innovative design and use of high quality materials HELLA Marine continues to set benchmarks for extremely reliable & highly efficient products. Globally recognised and trusted brand with LED navigation & high performance lighting systems available in over 60 countries through the global HELLA network & specialist marine distributors.

NS CODE	DESCRIPTION
A45010	LIGHT LED NAV PORT HELLA
A45020	LIGHT LED NAV STBD HELLA
A45028	LIGHT LED TOWING HELLA NAVI
A45030	LIGHT LED NAV STERN HELLA
A45040	MASTHEAD PRO 3 NM
A45041	MASTHEAD PRO 5 NM
A45044	LIGHT LED NAV 360 RED HELLA
A45043	LIGHT LED NAV 360 GREEN HELLA
A45045	LIGHT LED NAV 360 WHITE HELLA



Port and Starboard Nav Lights LED



Pro Masthead Light 3 NM



Pro Masthead Light 5 NM



360° Green 2 NM



360° Red 2 NM



360° White 2NM



Navi Towing Light

## SEALITE



Sealite's range of solar LED marine lanterns offer superior visibility, require minimal maintenance and have a service life of up to 12 years. The marine lanterns range from 1NM up to 13NM and can be used for a range of applications.

NS CODE	DESCRIPTION
A460XX	LIGHT SEALITE SL15 (Y, R, G, W)
A461XX	LIGHT SEALITE SL60 (Y, R, G, W)
A46700	BARGESAFE SEALITE SOLAR PORT 3 NM
A46710	BARGESAFE SEALITE SOLAR STBD 3 NM
A46715	BARGESAFE SEALITE SOLAR WHITE 3 NM
A46720	BARGESAFE SEALITE SOLAR STERN 3 NM



Sealite BargeSafe 3NM Solar



Sealite SL60



Sealite SL15

## ANODES

Zinc anodes are widely used in seawater environments and have been used for many years as a sacrificial, reliable and economical means of providing cathodic protection to the steel hulls of boats and ships. They can provide sufficient output to protect steel in higher resistivity environments, such as tidal areas and brackish to freshwater estuaries.

Suitable for hulls of ships and boats, ballast tanks, craypots, condensers, jetties, and subsea pipeline applications in bracelet configuration. The shape of the anode can be determined based on any of the following, the shape of the equipment or part to be protected, space availability and installation ease, accessibility of different shapes in different conditions; etc.

For example cylindrical pipelines are protected using cylindrical or bell-shaped anodes.

Land based applications include pipelines, piling and tanks for earthing, temporary and permanent protection.

Zinc anodes are not suitable for use in applications above 50°C.

\* Large range available, including aluminium & magnesium - please enquire.



**Anode Zinc Alloy Strap T/Drop**  
Quality zinc anodes with either Galvanised Steel Strap or Aluminum strap. Either are suitable for Fibreglass boats. Galvanised Steel Strap anodes can be fitted to Steel hull. Aluminum straps anodes can be fitted to Aluminum hull.



**Anode Zinc Oval Straps**  
Quality zinc anodes with either Galvanised Steel Strap or Aluminum strap. Either are suitable for Fibreglass boats. Galvanised Steel Strap anodes can be fitted to Steel hull. Aluminum straps anodes can be fitted to Aluminum hull.



**Zinc Rectangle Straps**  
Quality zinc anodes with either Galvanised Steel or Aluminum strap. Both suitable for Fibreglass boats. Galvanised Steel Strap anodes can be fitted to Steel hull. Aluminum straps anodes can be fitted to Aluminum hull.



**Bolt On Anodes, Teardrop**  
Streamlined Quality Teardrop Anodes. To suit commercial and leisure vessels, where streamlining is required. Two holes for bolting on.



**Engine Anodes**  
Large range of Quality Zinc engine anodes. Made for a variety of different engines. Suitable for use in engine cooling circuits to assist in protecting the dissimilar metals of heat exchangers, coolers and casings from electrolytic corrosion.



**Pencil Anodes**  
Quality zinc anodes. This pencil anode is suitable for use in engine cooling circuits to help protect the dissimilar metals of heat exchangers, coolers and casings from electrolytic corrosion.



**Round Anodes**  
Quality round zinc anodes in various size for various applications. To suit commercial and leisure vessels.



**Shaft Anodes**  
Quality anode in various shaft sizes. come complete with stainless steel bolts and nuts to fasten to your shaft (slot head).



**Rudder Anodes**  
Quality rudder zinc anodes in various size for various applications. To suit commercial and leisure vessels.



# CLEANING & SURFACE PROTECTION ANTI FOUL PRODUCTS

## CHEMTECH



The Chemtech range of marine & vehicle care and protection products have been developed to meet the demands of extreme climatic and environmental conditions.

Used extensively by boat owners, professional detailing, heavy vehicle trade, car, 4WD & Truck enthusiasts for over 20 years.

From wash and detailing products, degreasers, fuel additives, metal & aluminium cleaning & polishing products, Chemtech has all applications covered.

NS CODE	DESCRIPTION
E43260	CLEANER BILGE AND ENGINE CT14 1L
E43270	CLEANER BILGE AND ENGINE CT14 5L
E43280	DEGREASER CT14 20L
E43200	CLEANSING GEL CT18 1L
E43205	CLEANSING GEL CT18 5L
E43206	CLEANSING GEL CT18 20L
E43101	WASH N WAX CHEMTECH 1L
E43105	WASH N WAX CHEMTECH 5L



## ALTEX



Altex No.5 Antifouling is recommended where multi-season effective fouling protection is needed, and where regulations ban or restrict the use of organotin compounds.

Vivid® Aluminium safe antifouling is proven high performance protection. Vivid® provides excellent multi-season, dual biocide antifouling under all conditions for all substrates.

NS CODE	DESCRIPTION
R44054	ALTEX NO. 5, 4 LITRE TIN N/BUE
R45054	ALTEX NO. 5, 4 LITRE TIN AURORA RED
R46054	ALTEX NO. 5, 4 LITRE TIN CLASSIC BLACK
R44059	ALTEX NO. 5, 10 LITRE TIN N/BUE
R45059	ALTEX NO. 5, 10 LITRE TIN AURORA RED
R46059	ALTEX NO. 5, 10 LITRE TIN CLASSIC BLACK
R44011	PETIT VIVID BLUE 500ML TIN
R44014	PETIT VIVID BLUE 4L TIN
R45011	PETIT VIVID RED 500ML TIN
R45014	PETIT VIVID RED 4L TIN
R46011	PETIT VIVID ANTIFOUL BLACK 500ML TIN
R46014	PETIT VIVID ANTIFOUL BLACK 4L TIN
R46015	PETIT VIVID ANTIFOUL BLACK 10L TIN



## SEA BARRIER 3000

## CARBOLINE



Sea Barrier 3000 is a high performance, high copper loading, tin-free, ablative antifouling for a controlled and effective release of biocide during operation over extended service periods.



NS CODE	DESCRIPTION
R44134	SEA BARRIER 3000 BLUE 4 LITRE - 7.36KG
R46134	SEA BARRIER 3000 BLACK 4 LITRE - 7.36KG
R44139	SEA BARRIER 3000 BLUE 10 LITRE - 18.4KG
R46139	SEA BARRIER 3000 BLACK 10 LITRE - 18.4KG

# CLEANING AND PREVENTATIVE MAINTENANCE FOR MARINE FUELS

## FUEL DOCTOR

Fuel Doctor is a highly effective product at cleaning and protecting fuel from contamination as a result of airborne soil spores. Spores develop into organisms which feed on petrols and diesel, manifesting into slimy, sticky material that can plug and damage engines.

Fuel Doctor's state of the art formulation cleans gums and converts free water and microbial growths into microscopic particles. These particles are dispersed evenly throughout the fuel and harmlessly processed through combustion to exhaust.



NS CODE	DESCRIPTION
E43700	FUEL DOCTOR 250ML
E43702	FUEL DOCTOR 1.0L
E43704	FUEL DOCTOR 5.0L
E43706	FUEL DOCTOR 25L DRUM
E43708	FUEL DOCTOR 205L
E43710	FUEL DOCTOR 1000L ICB

# PROTECTION FOR UNDERWATER ASSETS

## PROPSPEED



Keep your running gear and any other underwater metals free of marine growth and protected against corrosion with PropSpeed.

Use PropSpeed on propellers, rudders, shafts, struts, trim tabs, IPS drives, thrusters, keel coolers or any underwater metal surface.

Two part product with strong etching primer that bonds firmly to metals, followed by an ultra smooth clear coat to prevent adhesion of marine growth.

PropSpeed™ Proclean and Propprep wipes available.

NS CODE	DESCRIPTION
R49051	PROPSPEED DIY 200ML SMALL
R49052	PROPSPEED DIY 500ML MEDIUM
R49053	PROPSPEED DIY KIT 1L LARGE
R49057	PROPSPEED DIY COMMERCIAL
R49058	PROPSPEED ETCHING PRIMER KIT
R49060	PROPSPEED CLEAR COAT 320ML



# SEALANTS & ADHESIVES

## FIXTECH

FixTech offer a wide range of sealants and adhesives for marine, construction and industrial projects, in tubes and sausages.



NS CODE	DESCRIPTION
E74230	GLAZING SEALANT FS200 BLACK
E74316	SEALANT FIXTECH FIX2 WHITE 125ML
E74320	SEALANT FIXTECH MSP15 MP WHITE 290ML
E74322	SEALANT FIXTECH MSP15 MP BLACK 290ML
E74334	SEALANT MS190 STRUCTURAL WHITE
E74336	SEALANT MS190 STRUCTURAL BLACK
E74351	SEALANT FIXTECH DECK CAULKING 290ML BLACK
E74352	SILICONE FIX 8 BLACK
E74354	SILICONE FIX 8 ALUMINIUM
E74356	SILICONE FIX 8 WHITE
E74358	SILICONE FIX 8 CLEAR

FIX200 FS200 is a high strength, multi-blended unique moisture curing silicone suitable for the fixing and sealing of organic and non-organic window panels, available in black only.

FixTech Fix 2 is available in a 125mL squeeze tube, and is a high quality single component joint sealant with high adhesive strength.

FIX15 is a high quality single component flexible adhesive joint sealant available in a 290mL cartridge and 600mL sausage.

FIX190 is a single component adhesive sealant offering ultimate high strength in structural bonding and direct glazing bonding and sealing.

FIX1DC is a high quality single component adhesive sealant with a low viscosity, great adhesive properties designed for Teak & Synthetic caulking.

FIX8 Silicone is a high quality architectural grade single component silicone sealant, available in white, translucent, aluminium and black.



# POLISH & STREAK REMOVAL

## STARBRITE



As well as offering premium Teak Care products, Starbrite offer high quality waterproofing, streak removal & polishing products for marine surfaces.

NS CODE	DESCRIPTION
E43225	BLACK STREAK REMOVER 650ML
E43226	WATERPROOFING 650ML
E43227	VIEW GUARD CLEAR PLASTIC
E43235	LIQUID RUBBING COMP HEAVY
E43240	PREMIUM MARINE POLISH 397G
E43242	PREMIUM MARINE POLISH 946ML



Teak Care products also available



# JOINTING COMPOUND

## DURALAC



Use in marine/industrial applications wherever two metal surfaces are joined – even where components of the same metal are in contact and where metals contact wood, rubber or synthetic materials.

NS CODE	DESCRIPTION
J30275	DURALAC 115ML

Ideal for between masts and spars, aluminium alloy plates, extrusions and bolts or rivets, for marine application where corrosion is accelerated by brine concentration.

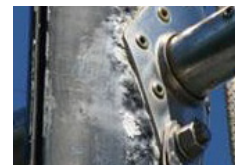

## ECHO SOUNDERS & FISH FINDERS

JRC



High accuracy and fast data processing, ideal for commercial fleets. Various models available.



## PROFESSIONAL RADAR SYSTEMS FEATURING ACCURATE, SUPERIOR TARGET CLARITY.



## COMMERCIAL AUTOPILOTS

TMQ

Designed and manufactured in Australia for professional mariners, established in Brisbane 1976.



(From top left) AP47C colour autopilot, AP9 designed for high speed vessels and ships, AP4 TMQ's commercial workhorse for professional vessels.

## C-PLOT

TMQ



C-PLOT is a flexible software solution designed for professional and recreational mariners. The C-PLOT overlay displays navigational data, historical track, user data such as marks & routes, as well as vessel data such as range and bearing.



## MARINE RADAR SYSTEMS

### RAYMARINE

Raymarine offers a wide range of marine radar systems for all types and sizes of boats. Day and night, radar systems from Raymarine keep you aware of surrounding traffic, hazards and obstacles, approaching weather and so much more. Use your boat's radar to navigate in dense fog or rain, or confirm your boat's position with super-accurate radar ranges.

**Raymarine**

Let MARPA and other innovative detection technologies help you navigate safely through a crowded harbor and enjoy map-like coastal detail when cruising offshore. Need a radar for fishing? Find sea birds at long range with Raymarine's state of the art detection algorithms to lead you to the fish.

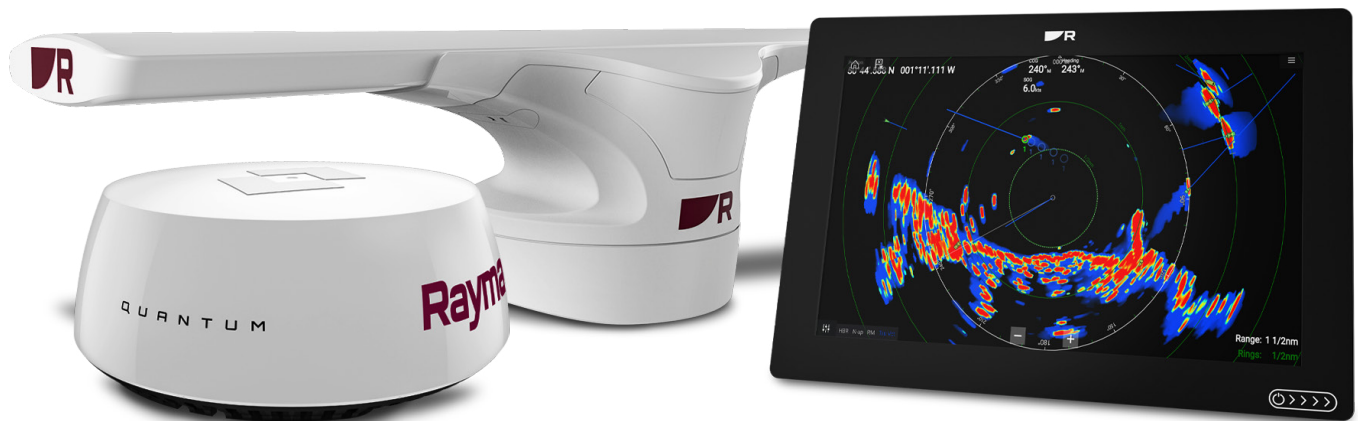

## CLEARPULSE CHIRP FISHFINDERS AND SONAR MODULES

Whether your passion is freshwater, inshore or offshore coastal fishing, our DownVision™, SideVision™ and new RealVision™3D fishfinder sonar modules allow you to image structure and find fish simultaneously- all with exceptional clarity.

With fish finders engineered for hobbyists and serious anglers alike, our range of sonar modules let you spend more time catching fish and less time looking for them.



## AUTOPILOTS

Raymarine autopilots feature vibrant colour displays and are powered by Raymarine's intuitive LightHouse user interface. Raymarine has a broad range of drive units to match almost any type of steering system.

No fuss, easy to install and robust - the Evolution autopilot control combines Raymarine's autopilot expertise, FLIR Systems' R&D, and advanced aerospace guidance technology to create Evolution Ai control algorithms that deliver a new level of accurate autopilot control.



## MARINE RADAR SYSTEMS

### SIMRAD



Professional, feature packed navigation equipment. State-of-the-art award winning radar technology, offering reduced weight and compact dimensions, thereby providing the best solution for installation even on small high speed craft.



## MULTI FUNCTION DISPLAYS

Simrad multifunction displays combine powerful fish-finding sonar technology with the chartplotter navigation features you need to plan trips and find your way on the water. SIMRAD fishfinders offer dedicated sonar displays, perfect for amateur anglers and offshore sportfishing pros.



## ADVANCED SONAR IMAGING - TRANSDUCERS

Complete your ultimate fish-finding system, by getting an entirely new view under the water with SIMRAD's range of imaging transducers. With higher resolution transducers see near picture like views under the water. Don't think it is a fish, know it is.

See structure and cover with a new level of refined detail and at a range unmatched by any other structure imaging technology with Active Imaging™ sonar.

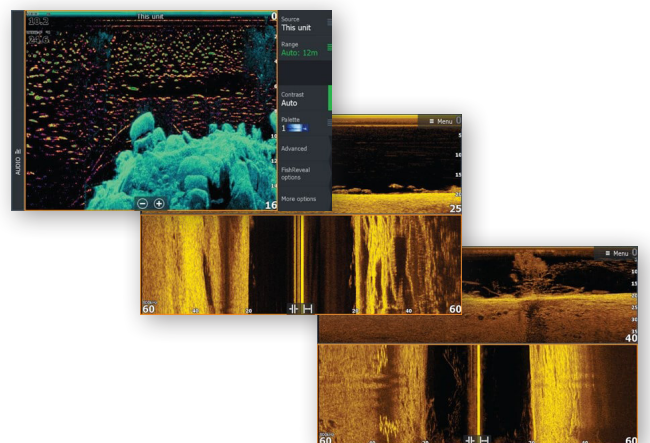

## SAILOR FLEET ONE COBHAM

Attractively priced reliable internet and global voice calling via SAILOR's compact antenna.

### Ideal for smaller vessels

- Compact 30cm antenna
- Easy installation
- Data connectivity up to 100kbps and voice calling on a single line
- Reliable Cobham network

### Easy to install

You don't need any specialist skills to install or run Fleet One. Simply plug in, set sail and get online, with easy-to-install and set up hardware.



## SATELLITE COMMUNICATIONS SYSTEM LARS THRANE LT-3100

Designed and built for the demanding and rough environment at sea.

- Voice, SMS, Data, and Vessel tracking
- 2.4 kbps and 9.6 kbps compressed data
- Programmable softkeys for e.g. Emergency Service
- Single antenna cable solution (up to 500 m)
- High-performance GNSS/GPS receiver
- High quality microphone, speaker, and equalizer for improved audio performance
- Bluetooth interface supporting voice, SMS, and data
- Voice prompt audio feedback
- Large 4.3" TFT display supporting day and night modes
- Firewall and user authentication for high level of security
- Web-server for configuration and maintenance
- Support external LAN Wi-Fi Access Points
- Support external SIP PABX and SIP handsets
- Connectivity of Smartphones, Softphones, and Apps

LARS  
**Thrane**



## ORIGINAL ROCNA ANCHORS

### ROCNA



Of all anchor types, a concave fluke gives the greatest resistance, and through clever design, Rocna provides the largest fluke area possible. In very soft seabeds, this provides the holding power to secure your boat. On hard or weedy sea floors, Rocna's chisel tip ensures that it cuts through and bites deep.

NS CODE	DESCRIPTION
G10604	ANCHOR ROCNA 4KG
G10606	ANCHOR ROCNA 6KG
G10610	ANCHOR ROCNA 10KG
G10615	ANCHOR ROCNA 15KG
G10620	ANCHOR ROCNA 20KG
G10625	ANCHOR ROCNA 25KG
G10633	ANCHOR ROCNA 33KG
G10640	ANCHOR ROCNA 40KG
G10655	ANCHOR ROCNA 55KG
G10670	ANCHOR ROCNA 70KG
G10699	ANCHOR ROCNA 110KG
G1070	ANCHOR ROCNA 150KG



## SARCA SUPER ANCHORS

### SARCA



Super SARCA Anchors are designed and manufactured in Australia, SARCA's build quality assured using the best steels then hot dipped galvanized, the stainless SARCA being of 316 stainless steel. Sizes up to Super SARCA #18 at 220kg.

NS CODE	DESCRIPTION
G10801	ANCHOR SUPER SARCA #1 4KG
G10802	ANCHOR SUPER SARCA #2 6KG
G10803	ANCHOR SUPER SARCA #3 9KG
G10804	ANCHOR SUPER SARCA #4 13KG
G10806	ANCHOR SUPER SARCA #6 22KG
G10807	ANCHOR SUPER SARCA #7 25KG



## SARCA EXCEL ANCHOR

The SARCA Excel is a certified Super High Holding Power anchor. The new generation anchor without a roll bar. The Excel will fit just about any anchor housing arrangement—pull pit and bow roller designs, the Excel caters for boats from the smallest run a bout to large ocean going work boats, yachts and trawlers. Sizes up to SARCA Excel #19 at 160kg.

NS CODE	DESCRIPTION
G10812	ANCHOR EXCEL SARCA #2
G10813	ANCHOR EXCEL SARCA #3
G10814	ANCHOR EXCEL SARCA #4
G10815	ANCHOR EXCEL SARCA #5
G10816	ANCHOR EXCEL SARCA #6



**WIDE RANGE OF ANCHORS  
AVAILABLE, CONTACT US  
FOR INFORMATION ON  
LARGER MODELS**



## ANCHOR WINCHES

### MUIR

MUIR designs and manufactures one of the largest ranges of anchor winches & mooring systems from 5 meter vessels up to 150 metres, including drum winches for work boats, fast ferries, naval and defence vessels up to 160 metres and up to 15,000kg pull.

MUIR is the preferred choice for your anchoring and mooring system solutions, no matter the size or style of your vessel.

- Horizontal Winches
- Drum Winches
- Vertical Windlasses
- Superyacht Winches
- Commercial Winches



Horizontal Winches



Drum Winches



Vertical Windlasses



Commercial Winches



Superyacht Winches

# THE ORIGINAL PLASTIC FENDER

## POLYFORM



Polyform AS was established in 1955 and was the first company in the world to produce inflatable, all-plastic net buoys and fenders. From the rough North Atlantic waters to the sunny tropics Polyform Norway products are made to withstand the toughest conditions and strains.

### A SERIES BUOY

NS CODE	DESCRIPTION
G20941	A0 280MM X 210MM (L X DIA) BUOY
G20940	A1 380MM X 295MM (L X DIA) BUOY
G20930	A2 500MM X 390MM (L X DIA) BUOY
G20920	A3 575MM X 460MM (L X DIA) BUOY
G20919	A4 710MM X 550MM (L X DIA) BUOY
G20918	A5 940MM X 710MM (L X DIA) BUOY
G20917	A6 1120MM X 850MM (L X DIA) BUOY
G20900	A7 1420MM X 1100MM (L X DIA) BUOY



Available in various colours, high strength A series buoys are designed with reinforced rope holds for maximum durability.

### F SERIES BUOY

NS CODE	DESCRIPTION
	F015 370MM X 130MM (L X DIA) BUOY
G21591	F01M 465MM X 130MM (L X DIA) BUOY F01L 560MM X 130MM (L X DIA) BUOY
G21552	F02 660MM X 200MM (L X DIA) BUOY
G21551	F1 610MM X 150MM (L X DIA) BUOY
G21592	F2 610MM X 220MM (L X DIA) BUOY
G21553	F3 745MM X 220 MM (L X DIA) BUOY
G21550	F4 1040MM X 220MM (L X DIA) BUOY
G21555	F5 775MM X 290 MM (L X DIA) BUOY
G21556	F6 1090MM X 290MM (L X DIA) BUOY
G21557	F7 1020MM X 375MM (L X DIA) BUOY
G21558	F8 1440MM X 375MM (L X DIA) BUOY
G21590	F11 1455MM X 590MM (L X DIA) BUOY F13 1880MM X 750MM (L X DIA) BUOY

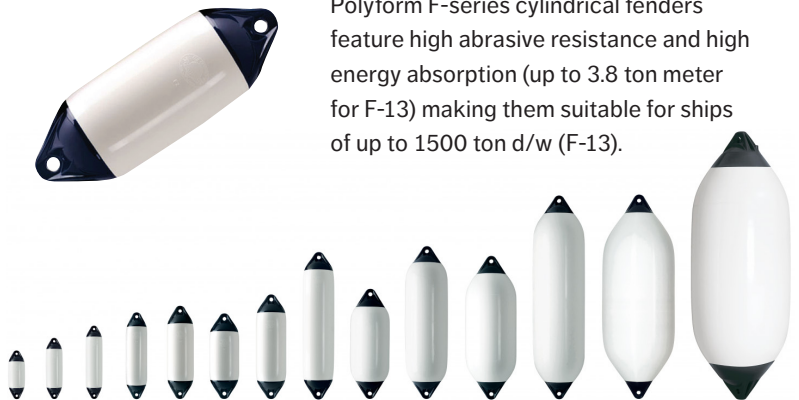

Polyform F-series cylindrical fenders feature high abrasive resistance and high energy absorption (up to 3.8 ton meter for F-13) making them suitable for ships of up to 1500 ton d/w (F-13).

### MOORING BUOYS

NS CODE	DESCRIPTION
G23450	BUOY MOORING POLYFORM MB-40Y
G23454	BUOY MOORING POLYFORM MB-100Y

Used for mooring, marking of fishing gear and cables, pipelines, and different other surface installations.



### SEALITE

NS CODE	DESCRIPTION
G20950	BUOY MARKER 700MM DIA SEALITE YELLOW



# CHAIN

## GALVANISED & STAINLESS STEEL CHAIN

NS CODE	DESCRIPTION
G12006	GALVANISED CHAIN 6MM SHORT LINK
G12008	GALVANISED CHAIN 8MM SHORT LINK
G12010	GALVANISED CHAIN 10MM SHORT LINK
G12013	GALVANISED CHAIN 13MM SHORT LINK
G21306	GALVANISED CHAIN 6MM REG LINK
G21308	GALVANISED CHAIN 8MM REG LINK
G21310	GALVANISED CHAIN 10MM REG LINK
F42302	STAINLESS STEEL CHAIN SS316 2MM
F42303	STAINLESS STEEL CHAIN SS316 3MM
F42304	STAINLESS STEEL CHAIN SS316 4MM
F42306	STAINLESS STEEL CHAIN SS316 6MM
F42308	STAINLESS STEEL CHAIN SS316 8MM

\*Larger sizes and stud link to order available



Galvanised short link chain



Stainless Steel regular link chain

## STAINLESS STEEL HARDWARE

### STAINLESS STEEL SWIVELS

NS CODE	DESCRIPTION
L13034	SWIVEL ANCHOR 3 WAY 6-8MM
L13040	SWIVEL ANCHOR WITH TWIST 6-8MM
L13042	SWIVEL ANCHOR WITH TWIST 10-12MM

## ANCHOR CONNECTORS

### SWIVEL ANCHOR CONNECTOR

NS CODE	DESCRIPTION
B33320	SWIVEL ANCHOR CONNECTOR KONG 6-8MM
B33322	SWIVEL ANCHOR CONNECTOR KONG 8-12MM
B33324	SWIVEL ANCHOR CONNECTOR KONG 12-13MM



## GALVANISED SWIVELS

NS CODE	DESCRIPTION
L13010	SWIVEL HOT DIP GALV 10MM
L13013	SWIVEL HOT DIP GALV 13MM
L13016	SWIVEL HOT DIP GALV 16MM
L13020	SWIVEL HOT DIP GALV 20MM
L13025	SWIVEL HOT DIP GALV 25MM



## QUICK LINKS

NS CODE	DESCRIPTION
B21060	QUICK LINK SS316 6MM
B21080	QUICK LINK SS 16 8MM
B21100	QUICK LINK SS316 10MM



## JOINING LINKS

### LINK CHAIN

NS CODE	DESCRIPTION
L12608	JOINING LINK CHAIN STAINLESS STEEL 8MM
L12610	JOINING LINK CHAIN STAINLESS STEEL 10MM
L12612	JOINING LINK CHAIN STAINLESS STEEL 12MM

## FALCON BRAID

### IRB INTERNATIONAL ROPE BRAID



Falcon Braid with core UHMWPE, is light and strong, very low stretch, and has excellent UV and wear resistance. Ideal for halyards

NS CODE	DESCRIPTION
H149XX	FALCON BRAID SK62 UHMWPE 2MM – 32MM, VARIOUS COLOURS
H78110	H78110 FALCON BRAID SK62 UHMWPE 2MM – 32MM, VARIOUS COLOURS



## DOUBLE BRAID

100% Polyester Core and Cover. Double Braid, also known as Bowline Braid, is designed with optimal strength & density, for longer life & consistent performance. Easy to use and has thousands of applications. Very good UV properties & flexibility. Ideal for sheets

NS CODE	DESCRIPTION
H130XX	DOUBLE BRAID 2MM – 32MM, VARIOUS COLOURS



## SINGLE BRAID DYNEEMA

Rope Features: 15 times stronger than Steel, Low Stretch, Floats on Water, Flexible, Resistant to Chafe, UV and Breakage.

NS CODE	DESCRIPTION
H145XX	DYNEEMA® SK78 2MM – 24MM

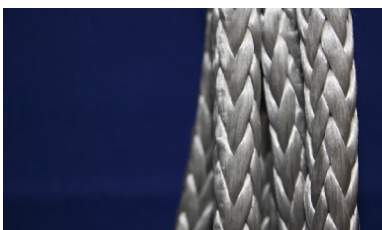

## SILVER ROPE

### A.T.S. ROPE & NETS



Silver Rope is soft and easy to handle, making it ideal to use as a general purpose rope.

NS CODE	DESCRIPTION
N300XX	ROPE SILVER 6-40MM

## NYLON ROPES

### RWB MARINE



Nylon rope is the strongest and most elastic synthetic fibre UV resistant rope. It is easy to handle, has great elasticity, shock absorption & abrasion resistance.

NS CODE	DESCRIPTION
H200XX	ROPE NYLON 6MM-18MM

## AQUATEC & TIGER ROPE

### DONAGHYS



Aquatec & Tiger Rope are ideally suited to applications of marine fishing & heavy industrial use where reliability is key.

NS CODE	DESCRIPTION
N41208	ROPE AQUATEC 8MM-32MM 250M
N48038	ROPE TIGER 8 STRAND 24MM X 220M YLW/BLK
N48048	ROPE TIGER 8 STB 48MM X 220M YLW/BLK

\*Cut lengths also available, as well as other diameters



## POLYPROPYLENE ROPE

Polyester abrasion, UV resistance with high strength provide a high performance low cost mooring rope with neutral buoyancy.

NS CODE	DESCRIPTION
N402XX	ROPE SEA GREEN POLYPROP FLOATING 4MM-18MM
N48575	ROPE SEA GREEN POLYPROP 20MM



# GENERAL NAVIGATION TOOLS

## BOAT BOOKS AUSTRALIA



Navigation equipment to suit paper charts and maps.

NS CODE	DESCRIPTION
C29030	COMPASS PENCIL
C28410	DIVIDERS SINGLE HAND 7INCH
C28420	DIVIDERS SINGLE HAND 8INCH
C28340	RULER PARALLEL CAPT FIELDS 400MM
C28350	RULER PARALLEL CAPT FIELDS 500MM
C28360	RULER PARALLEL CAPT FIELDS 600MM

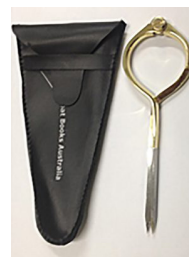
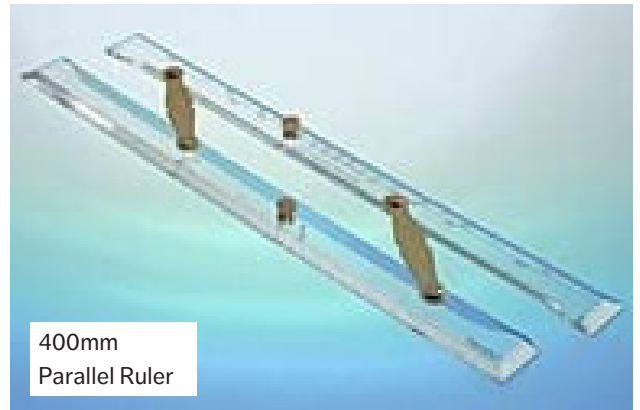

Single divider 7"



Single divider 8"



Compass

# REFERENCE BOOKS & PAPER CHARTS

Need a particular book or paper chart? Our showroom locations stock a wide variety of reference materials.

- Australian Charts
- British Admiralty IACA
- New Zealand Navy Charts
- IMO, ITU, Witherby and SOLAS regulated publications
- BridgeWatch Folio Management system

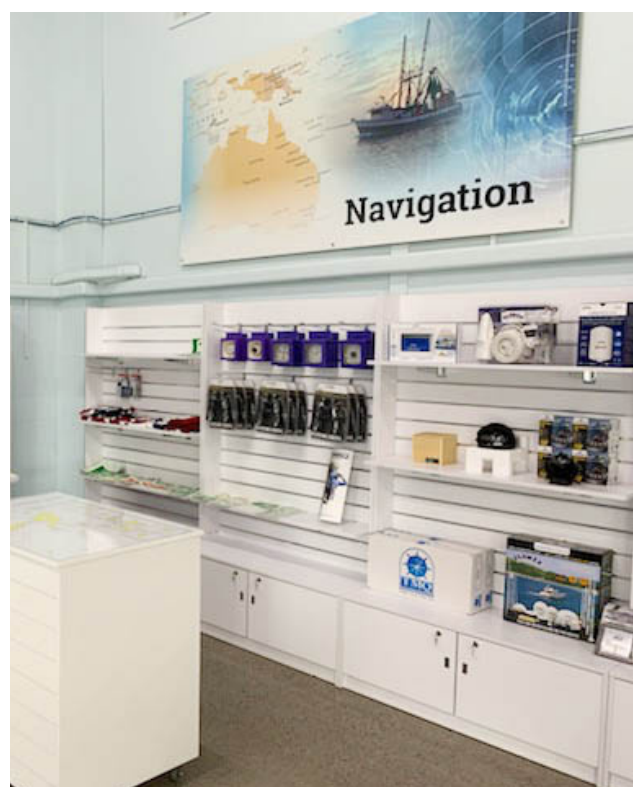
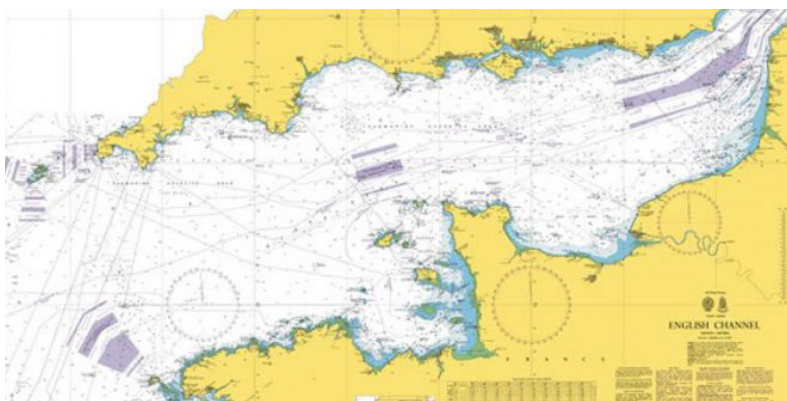

## IMPELLER PUMPS AND SPARES

### JOHNSON



Flexible impeller pumps provide an efficient solution to most marine pumping needs. The primary advantage of them is their self-priming capability, followed by their ability to pump a wide range of liquids and even semi liquids.

NS CODE	DESCRIPTION
C10010	PUMP TRANSFER 3/8 BSP F4B-8
C10015	PUMP TRANSFER 3/4 BSP F5B-8
C10020	PUMP TRANSFER 3/4 BSP F7B-8

\*Sizes from 3/-2.5m available



## PUMP IMPELLERS

NS CODE	DESCRIPTION
C10285	F4 IMPELLER 09-810B
C10290	F4 IMPELLER 09-810B-9 (NITRILE)
C10230	F5 IMPELLER 09-1027B
C10235	F5 IMPELLER 09-1027B-9 (NITRILE)
C10240	F7 IMPELLER 09-1028B
C10245	F7 IMPELLER 09-1028B-9 (NITRILE)

Plus many more

## BILGE PUMPS

### MARCO S.P.A



NS CODE	DESCRIPTION
A70371	PUMP BILGE MARCO UP500 32LPM 12V
A70372	PUMP BILGE MARCO UP500 32LPM 24V
A70375	PUMP BILGE MARCO UP1000 63LPM 12V
A70379	PUMP BILGE MARCO UP1500 95LPM 12V
A70383	PUMP BILGE MARCO UP1500 95LPM 24V
A70387	PUMP BILGE MARCO UP2000 126LPM 12V
A70391	PUMP BILGE MARCO UP2000 126LPM 24V



Completely submersible bilge pumps. Compact design with ABS material housing, corrosion resistant.

## BILGE PUMPS

Electric submersible bilge pumps. Improved design with easy-to-install Dura-Port discharge ports to eliminate stress cracking caused by over-tightened hose clamps.

NS CODE	DESCRIPTION
M10015	PUMP BILGE JP L550 12V
M10020	PUMP BILGE JP L650 12V
M10025	PUMP BILGE JP L1250 12V
M10030	PUMP BILGEJP L1600 12V
M10040	PUMP BILGE JP L2200 12V
M10045	PUMP BILGE JP L2200 24V
M10050	PUMP BILGE JP L4000 12V
M10055	PUMP BILGE JP L4000 24V



## PUMPS & SPARES

### TMC



NS CODE	DESCRIPTION
M15125	MACERATOR + MOTOR ASSEMBLY TMC 12V
M15126	MACERATOR + MOTOR ASSEMBLY TMC 24V
M15145	KIT BODY TO SUIT TMC SP619



Self priming 12 macerator waste pump, used to empty holding tanks, or transfer waste from holding tank toilets to main holding tank.

## BILGE PUMPS & SPARE PARTS

### RULE



Fully submersible pumps designed for bilge or bait application. Extremely efficient, draws low current and offers high capacity output in a very compact housing.

NS CODE	DESCRIPTION
M20100	PUMP BILGE RULE 360 22LPM 12V
M20112	PUMP BILGE RULE 500 32LPM 12V
M20120	PUMP BILGE RULE 1100 69LPM 12V
M20140	PUMP BILGE RULE 1500 94LPM 12V
M20145	PUMP BILGE RULE 1500 94LPM 24V
M20160	PUMP BILGE RULE 2000 126LPM 12V
M20180	PUMP BILGE RULE 2000 126LPM 24V
M20190	PUMP BILGE RULE 4000 252LPM 12V
M20195	PUMP BILGE RULE 4000 252LPM 24V
M20130	PUMP BILGE AUTO 500 RULE 12V



## FLOAT SWITCHES

NS CODE	DESCRIPTION
M10110	SWITCH FLOAT JOHNSON 12/24V
M10120	SWITCH FLOAT ULTIMA 12/24V
M20040	SWITCH FLOAT RULE MODEL 35
M20245	SWITCH FLOAT RULE-A-MATIC PLUS
M10110	FLOAT SWITCH JOHNSON



## FRESH WATER PUMPS

### SHURFLO



NS CODE	DESCRIPTION
A70050	PUMP FRESH WATER SHURFLO 12V
A70052	PUMP FRESH WATER SHURFLO 24V



Shurflo pumps are known throughout the world as a leading supplier of quality 12v and 24v water pumps for marine fresh water and deck wash pumps, also suitable for caravan and camping.

## MACERATOR PUMPS

### AND SPARES



### JABSCO

NS CODE	DESCRIPTION
M15050	MACERATOR PUMP JABSCO 18590-2092 12V
M15390	MACERATOR PUMP JABSCO 18590-2094 24V
C15600	KIT SERVICE TO SUIT JABSCO MAC 18590

DC Macerator Pump - 4 Blade  
Stainless Steel Chopper



## CLUTCH PUMPS & SPARES

NS CODE	DESCRIPTION
C15035	PUMP CLUTCH 1 INCH BSP PORT 24V 1XB
A70120	PUMP CLUTCH 1.5 INCH BSP PORT 24V 1XB
A70150	PUMP CLUTCH 2 INCH BSP PORT 24V 1XB
C15032	PUMP CLUTCH 1.5 INCH FLANGE PORT 24V 1XB
A70152	PUMP CLUTCH 2 INCH FLANGE PORT 24V 1XB

A range of heavy duty bronze pumps with flexible impellers, electrically operated clutches (12 or 24 volt) and long life mechanical seal.



## SELF PRIMING PUMPS

NS CODE	DESCRIPTION
A70010	PUMP JABSCO 32LPM 23680-4003 12V
A70000	PUMP JABSCO 32LPM 23680-4103 24V
A70030	PUMP 11LPM PARMAX 3 12V

The JABSCO "WATER PUPPY" range of flexible impeller pumps have 12 volt DC motors for many applications including bilge pumping, deck wash, shower drain and many other general purpose applications.



# Is your life raft **overdue** for a service?



**Safety equipment can only protect you  
and your crew if it is in **working order.****

Depending on brand and pack type, life raft service intervals can be 12, 24, or 36 months. Following the recommended service timetable from your raft's manufacturer ensures your warranty stays valid, and that your raft will function as expected in an emergency.

**Book a service at your nearest Nautical branch:  
Enquire about our Life Raft Hire**

Our friendly Service Department can also service Life Jackets and Dan Buoys from many major brands:

