



22



SAILBOAT HARDWARE

WELCOME

We've updated our catalogue for 2022, bringing together the complete Ronstan product range in an interactive digital format. You'll find all of our recent new releases, including:

- Our new Triggersnaps™ range of snap shackles, allowing quick and intuitive one-handed operation for attachment and release, each one individually proof-load tested and stamped with a production code for traceability.
- New spinnaker pole ends with integrated trigger and internal trip line, compatible with most common pole sizes.
- The stylish new RF4056 ClearStart™ analogue sailing watch.
- The Andersen 68ST and 72ST E2 two-speed electric winches, delivering faster line speeds across the full load range.

The health emergency of 2020 has been an experience that we will never forget, and hopefully never have to repeat. We hope that you and your families, friends and colleagues are well, and are resuming the activities that you enjoy the most.

For many of us, sailing is right at the top of that list. Things may not be quite the same while some of our favourite regattas, boat shows and other events are not being held, but we will still be out on the water making the most of the wind and the waves. Hope to see you there!

Scot West

Managing Director
Ronstan International Pty. Ltd.

BLOCKS

Sports Blocks - Features & Information	4-5
Series 15 & 20 Utility	6
Series 15 BB Utility	7
Series 20 BB Orbit	9
Series 20 BB Utility	10-11
Series 25 & 30 AP Utility	12-13
Series 30 BB Orbit	14-15
Series 30 BB Utility	16
Series 40 BB Orbit	18-19
Series 40 BB Ratchet Orbit	20
Series 40 BB Utility	22-23
Series 40 AP Utility	24-25
Series 50 BB Utility	26
Series 50 AP Utility	28-29
Series 60 AP Utility	28
Series 55 BB Orbit	30-33
Series 55 BB Ratchet Orbit	34-36
Series 60 BB Ultimate Ratchet	37
Series 75 BB Ultimate Ratchet	39
Series 75 BB Ultimate Ratchet 2-Speed Mainsheet Systems	40
Deck Organisers	41
Wire Blocks, Sheave Boxes, Exit Blocks	42
Upright Lead Blocks	43

RopeGlide™ Solutions

Shocks™	45
Rings	46
Fairleads	47

Keelboat Blocks - Features & Information

Series 45 Core	51
Series 60 Core	52-53
Series 60 Orbit	55
Series 75 Core	56
Series 75 Orbit	57
Series 100 Core	59
Series 100 Orbit	60-61
Series 125 Orbit	62
Series 150 Orbit	63
Series 180 Orbit	64
Series 200 Orbit	65
Upright & Pivoting Low Lead Blocks	66
Snatch Blocks	67
Soft Attachment Blocks - Features & Information	68
Soft Attachment Blocks	69
Sheaves	70-71

CLEATS

V-Cleats™	73
Cam Cleats - Features & Information	74
Cam Cleats & Accessories	75-77
Swivel Cleat Units	78-79
Rope Jammers & Cleats	82

RUDDER & TILLER HARDWARE

Battlestick™ Tiller Extensions - Features & Information	83
Battlestick™ Tiller Extensions	84
Rudder Hardware	85

COVER IMAGE

© Surfsailkite / Mitch Pearson
www.surfsailkite.com.au
TP52 'Enve Scooters', Sydney to Hobart, 2019

TRACK & TRAVELLER SYSTEMS

Series 19 C-Track	87
Series 25 T-Track	88-89
Series 32 T-Track	90
Series 19 I-Track	92
Series 32 I-Track	93
Ball Bearing Traveller Systems - Features & Information	94
Series 14	95
Series 19	96-98
Series 22	99-103
Series 26	104-106
Series 30	108-114
Series 42	116-123
Series 55	124-128
Track Data	130
Curved Track Data	131

FURLERS

Small Boat Furlers	132-133
Continuous Line Furlers - Features & Information	134-135
Continuous Line Furlers & Accessories	136-138

BATTEN CAR SYSTEMS

Ballslide™ Batten Systems - Features & Information	139
Series 6	140-141
Series 8	142-143
Ballslide™ Car/Foot & Track Mounting Slug Information	144
Track & Car Batten Systems - Features & Information	145
Series 14	146-147
Series 19	148-150
Series 22	151-153
Series 26	154-156
Series 30	157-159
Series 42	160-163
Series 55	164-166
Links & Receptacles	167

MISCELLANEOUS HARDWARE & ACCESSORIES

Sailmaker Hardware	168-169
Hooks & Clips	170
Rings, Thimbles & Fairleads	171
Bushes	172
Rope Stopper Balls & Handles	173
Plumbing Fittings	174
Inspection Hatches & Drain Plugs	175
Wind Indicators	177
Stay Adjusters, Hounds & Tangs	178
Trapeze Hardware	179
Spinnaker & Spar Hardware	180
Spinnaker Pole Ends	181
Life Line Hardware	182
Cockpit Accessories	183
Cable Steering Hardware & Buoys	184
BoatSmart™ Boat Care Products	185

SAILING GEAR & ACCESSORIES

Sailing Gear - Features & Information	186
Skiffsuit™	187
Neoprene Pants & Shorts	188
Neoprene, Thermal & Rash Tops	189
Smock Top	190
Layering Options	191
Gloves & Cap	193
Shoes & Boots	194
Accessories, Gear Bag & Tuning Aids	195
Weatherproof Bags	196-197

SAILING GEAR & ACCESSORIES (CONT.)

ClearStart™ Watches & Race Timer - Features & Information	198
ClearStart™ Race Timer and Analogue Watch	199
ClearStart™ Watches	200-201

STAINLESS STEEL HARDWARE

Shackles	202-203
Snap Shackles and Triggersnaps™	204-205
Hooks, Quick Links & Welded Rings	206
Swivels, Sister Clips, S-Hooks & Beckets	207
Stand-up Springs & Boots	208
Padeyes & Saddles	209-210
Removable Lashing Padeyes	211
Eye Bolts & U-Bolts	212

RIGGING HARDWARE

Turnbuckle - Features & Information	213
Calibrated Turnbuckles	214-217
Swage/Toggle Turnbuckles	218-221
Toggle/Toggle Turnbuckles	222
Eye/Toggle Turnbuckles	223
Eye/Eye Turnbuckles	224
Threaded Swage Terminals	225-226
Toggle Swage Terminals	227
Eye Swage Terminals & Fork Swage Terminals	228
Double Jaw Toggles & Lock Nuts	229
Pins & Rings	230
Hand Swage Fittings	231
Stainless Steel Wire	232

INDUSTRIAL PRODUCTS

Soft Links & Soft Shackles	234
Commodity Grade Stainless Steel Hardware	
Carabiner, Snap & Pelican Hooks	235
Snap Shackles, Pad Eyes & Eye Coach Screws	236
Andersen Automatic Bailers	237
Industrial Pulley Blocks - Features & Information	238
Series 60	239
Series 75	240-241
Fall Arrest Systems - Features & Information	242-243
Series 22	244
Series 30	245
Removable Screw-In Padeye	246

ANDERSEN STAINLESS STEEL WINCHES®

Contents	247
Winch Selection	248
Winch - Features & Information	249
Self Tailing Range Overview	250
Manual Self-Tailing Winches	251
Special Finishes	252
Electric Winches	
E1	253-255
E2	256
Three Speed	257-259
Compact Motor™, Variable Speed	261-265
Hydraulic Winches	
Single Speed	266
Three Speed	267
Classic Winches	268-269
Winch Handles & Pockets	270-272
Winch Accessories	273

Product Number Index	274-280
Customer Considerations, Warranty & Definitions	281
Office Listings, Website Address	Back Cover

BLOCKS

CLEATS & CLUTCHES

RUDDER & TILLER

TRACK & TRAVELLER SYSTEMS

FURLERS

BATTEN CAR SYSTEMS

MISCELLANEOUS HARDWARE & ACCESSORIES

SAILING GEAR & ACCESSORIES

STAINLESS STEEL HARDWARE

RIGGING HARDWARE

INDUSTRIAL PRODUCTS

ANDERSEN STAINLESS STEEL WINCHES®

INDEX & INFORMATION

A

Andersen Bailers	237
Andersen Stainless Steel Winches®	247-269
All Purpose Utility Blocks	5,6,12,13,24,25,28,29

B

Bags	195-197
Bailers	237
Ballslide™ - Batten Car Systems	139-144
Batten Car Systems & Accessories	139-167
Batten Links & Receptacles	167,169
Battlestick™ Tiller Extensions	83,84
Ball Bearing Utility Blocks	5,7,10,11,16,22,23,26,40
Beam Track Data	130
Block Swivel Bases	78,79
Blocks - Core Blocks™	51,52,53,55,56,59
Blocks - Industrial Blocks	238-241
Blocks - Orbit Blocks™, Keelboat	48,49 51-69
Blocks - Orbit Blocks™, Small Boat	4,9,14,15,18-20,30-36
Blocks - Keelboat	48-69
Blocks - Exit	42
Blocks - Foot/Cheek, Keelboat	53,55-57,59,60,62-64
Blocks - Foot/Cheek, Small Boat	7,11,13,15,19,20,25,29,31,36
Blocks - Fiddle	13,19,23,25,26,29,32,33,36
Blocks - Lashing Orbit Blocks™	9,14,55,57,60-65
Blocks - Pivoting Lead	37,39,43,66
Blocks - Ratchet	4,20,34-37,39,40
Blocks - Two-Speed Mainsheet Systems	40
Blocks - Upright Lead	43,66
Blocks - Wire	10,11,14,16,22,26,42,43,52,56,240,241
Blocks - Sports	4-43
Boat Care Products	185
Boots	194
Bungs	175
Buoys	184
Bushes - Plastic	172

C

Cable Steering Hardware	184
Calibrated Turnbuckles	214-217
Cam Cleats & Accessories	74-77
Caps	193
Carabiners	206,235
C-Cleat™ Cam Cleats	74-77
Chain Plates	178
Cheek Blocks - Keelboat	53,55-57,59,60,62-64
Cheek Blocks - Small Boat	7,11,13,15,19,20,25,29,31,36
Classic Winches	268,269
ClearStart™ Timer & Watches	198-201
Clevis Pins	230
Clips & Hooks - Plastic	170
Clothing	186-194
Cockpit Accessories	183
Commodity Grade Stainless Steel Hardware	235,236
Continuous Line Furlers	134-138
Control Ends - Traveller	92,93,98,103,106,113,122,128
Copper Ferrules	231
Core Blocks™	48,51-53,56,59
C-Track Slide Systems	87
Curved Track Data	131

D

Deadeyes	171
Deck Clips	207

D (continued)

Deck Organisers	41
Double Jaw Toggles	229
Drain Plugs	175
Drink Holders	183
Soft Links	234

E

Electric Winches	253-265
Exit Blocks	42
Exit Plates	178
Eye Bolts	212

F

Fairleads - Alloy	47
Fairleads - Plastic	172
Ferrules	231
Fiddle Blocks	13,19,23,25,26,29,32,33,36
Flag Clips	170,207
Foot Blocks - Keelboat	53,55-57,59,60,62-64
Foot Blocks - Small Boat	7,11,13,15,19,20,25,29,31,36
Footwear	194
Friction Rings	46
Furlers & Accessories	132-138

G

Gear Bags	195-197
Genoa Cars	88-90,97,101,105,110,118,119,126,127
Gloves	193
Gudgeons	85

H

Halyard Bags	183
Halyard Tail Cars	112,121
Handles - Plastic	207
Hanks	169
Headboard Cars & Plates	140,142,146,148,149,151,152,154,155, 157,158,160,161,164
Headsail Cars	87-90,96,97,101,110,118,119,126,127
Headsail Sheet Leads	87-90
Hinges	173
Hooks & Clips - Stainless Steel	206,207,235
Horn Cleats	82
Hounds	178
Hydraulic Winches	266,267

I

Industrial Blocks	238-241
Inspection Hatches/Ports	175
I-Track & Cars	92,93

J

Jam Cleats	73,82
Jib Cars - Sliding	87-90

K

Kite Blocks	6-10,14
-------------	---------

L

Lashing Blocks - Keelboat	55,57,60-65
Lashing Blocks - Small Boat	9,14
Life Line Hardware	182
Lock Nuts - Turnbuckles	229
Low Friction Fairleads	47
Low Friction Rings	46

M

Mainsheet Cars	92-125
Mainsheet Cleat Units	79
Mainsheet Systems - Two-Speed	40
Manual Winches	249-252,268,269
Mast Chocks	180
Mast Hardware	178-182
Mooring Buoy	184

O

Orbit Blocks™ - Keelboat	48,49 51-69
Orbit Blocks™ - Small Boat	4,9,14,15,18-20,30-36
Outhaul Slides	87-90
Outhaul Cars	92,93,95,96,102,105,111,120,127

P

Pad Eyes	209-211
Parrel Beads	173
Pelican Hooks	182
Pins - Stainless Steel	230
Pintles	85
Pivoting Lead Blocks	37,39,43,66
Plastic Hardware	168-175
Plumbing Fittings	174
Polishes	185
Protest Flag	195
Punched Strip	178

Q

Quick Links	206,235
Quick-Lock™ Winch Handles	270,272

R

Rash Tops	189
Ratchet Blocks	4,20,34-37,39,40
Retaining Rings & Clips	85,230
Rigging Fittings	213-232,235,236
Rigging Screws	213-224
Rings - Plastic	177
Rings - Stainless Steel	206,230
Rope Bags	183
Rope Cleats	73-82
RopeGlide™ Solutions - Rings & Fairleads	45-47
Rope Jammers & Cleats	82
Rope Stopper Balls	173
Rudder Fittings	85

S

Saddles	209
Safety Rail Systems	242-246
Sail Slides & Slugs	168
Sailing Gear & Accessories	186-201
Sailmaker Hardware	168,169
Shackles	202,203
Sheave Boxes	42
Sheaves	70,71
SHOCKS™ - Sheaveless Blocks	45
S-Hooks	207
Silicone Spray	185
Sister Clips	170,207
Skiffsuit™	187
Skin Fittings	174
Smock Tops	190
Snap Hooks - Stainless Steel	206,207,235
Snap Hooks - Plastic	170

S (continued)

Snap Shackle Blocks	23,25,26,29,51-53,67
Snap Shackles	204,205,236
Snatch Blocks	67-69
Soft Attachment Blocks	68,69
Soft Links	234
Soft Shackles	234
Spar Hardware	178-182
Spinnaker Hardware	180,181
Spinnaker Pole Cars	88,89,102,111,120
Spinnaker Pole Ends	181
Split Rings	230
Stainless Steel Wire	232
Stand-Up Springs & Boots	208
Start Timer - ClearStart™	198,199
Stanchion Block	132
Stay Adjusters	178
Swage Fittings - Hand	231
Swage Terminals	225-228
Swaging Dimensions	229
Swivel Cleat Units	78,79
Swivels - Furling	132,133,136,137
Swivels - Stainless Steel	203,207

T

Tangs	178
T-Cleat™ Cam Cleats	74-77
Tell Tails	195
Thimbles - Plastic	171
Thimbles - Stainless Steel & Sailmaker	231
Tie Balls	179
Tiller Extensions & Accessories	83,84
Timer - ClearStart™	198,199
Toggle Pins	230
Track Curving Data	131
Trapeze Hardware	179
Traveller Control Ends	92,93,98,103,106,113,122,128
Traveller Systems - Ball Bearing	94-131
Traveller Systems - I-Track	92,93
Triggersnaps™	205
T-Track Slide Systems	88-93
Tube Clips	84,170
Turnbuckles	213-224
Two-Speed Mainsheet Systems	40

U

U-Bolts	212
Universal Joints - Tiller Extensions	84
Upright Lead Blocks - Keelboat	66
Upright Lead Blocks - Small Boat	43

V

V-Cleats™	73
Venturi bailers - Andersen bailers	237

W

Warranty Information	281
Watches - ClearStart™	198-201
Wetsuits	187-189
Winch Handle Pockets	183,272
Winch Handles & Accessories	269-272
Winches - Andersen Stainless Steel Winches®	247-269
Wind Indicators	177
Wire Blocks	10,11,14,16,22,26,42,43,52,56,240,241
Wire Rope - Stainless Steel	232
Wire Rope Grips	231
Wind Vane Pro	176



Ball Bearing Orbit sheave



Ratchet block auto/manual models

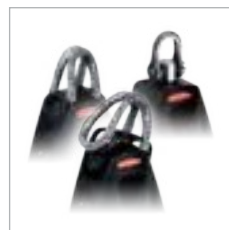

Dyneema® link or shackle head



Adjustable cleat arms



Ratchet block auto engagement



Ratchet block holding power

ORBIT BLOCKS™

ULTIMATE PERFORMANCE

Ball Bearing Orbit Blocks™ have been engineered to achieve the highest possible strength-to-weight ratio, using composite reinforced polymer materials and a Dyneema® link attachment instead of metal components.

The unique orbital version of our 2-stage ball bearing system maximises the available bearing surface and positions recirculating ball bearings exclusively within the loaded area of the sheave. A secondary full-contact bearing maintains low friction across the full working load range.

The Dyneema® link, realised in high-grade SK78 fibre, is easily fitted and retained securely by a moulded retainer clip. The flexible link allows limited articulation in a 0° or 90° orientation, while swivel head models with stainless steel shackles provide full rotation and ultimate durability.

Orbit Blocks™ are fitted with our carbon-fibre reinforced C-Cleat™ for secure rope holding with low entry and exit efforts, and fairleads for fast action from any angle. Cleat arms have a wide range of adjustment and calibration marks for setting your preferred cleating angle.

AWESOME HOLDING POWER

Multiple gripping faces machined into our ratchet block sheaves work in conjunction with our unique cross-hole geometry, delivering up to 20:1 holding power to resist slipping of the loaded line while minimising rope wear. Ball bearings ensure minimum friction under load and a free running sheave when the ratchet is disengaged.

Control switches are located on both sides of the block to remain accessible wherever the block is fitted. In auto mode, the ratchet mechanism engages when load is applied but disengages when released to let the sheet run out freely – ideal for gybing asymmetric spinnakers. In manual mode, the switch is used to set up the block with ratchet either on or off as required.

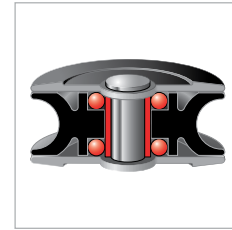

Ball Bearing sheave

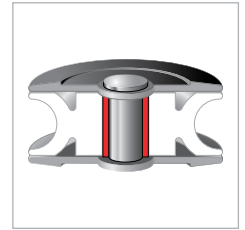

All Purpose & Special Purpose sheave



RopeGlide™ fairleads



RopeGlide™ rings



Versatile Shocks™



A BLOCK FOR EVERY PURPOSE

ALL-AROUND SOLUTIONS

Utility Blocks are an ideal match for the needs of everyday recreational sailing. They are designed for low-maintenance reliability and offer a choice of sheave/bearing configurations depending on their intended use.

ULTIMATE SIMPLICITY

For applications involving high static loads where only simple deflection and minor trim adjustment is required, our low friction RopeGlide™ rings and fairleads are a lightweight and robust alternative to blocks. For control line applications our Shocks™ offer high strength and versatility in a compact form.

AP **All Purpose** versions are a great choice for durability and a long service life. They feature self-lubricating acetal polymer sheaves running on polished stainless steel races and perform equally well with dynamic loads and static loads.

BB **Ball Bearing** versions incorporate our 2-stage bearing system using ball bearings to minimise friction and a secondary full-contact bearing to maintain low friction across the full working load range.

SP **Special Purpose** versions are suitable for use with wire rope or where high static load capability is required.

HHL **High Load** versions are designed specifically for any application where high dynamic or static loads are expected. They feature high strength grade 2205 stainless steel ball races and sheaves for low friction at high dynamic loads.



©Toby Bromwich

SERIES 15



SERIES 20

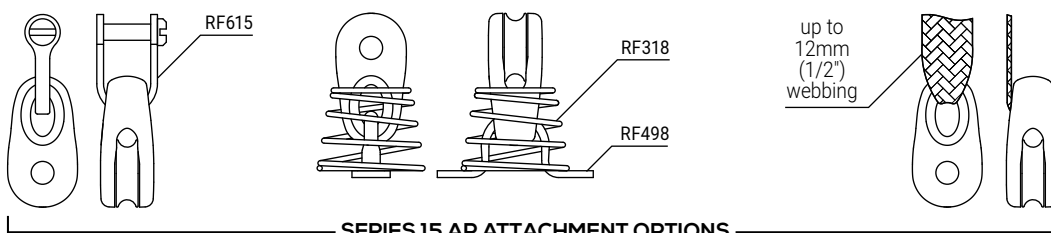

SERIES 15 AP ATTACHMENT OPTIONS

RF806S
4.8mm (3/16") pin,
suits RF662

- Control lines.
- Leech lines.
- Shock cord tensioning systems.
- Sheaves: UV stabilised acetal.
- Cheeks & rivets (Series 20): Grade 316 stainless steel.
- Frame/cheeks (RF13101): Impact resistant nylon.

PRODUCT No.	DESCRIPTION	SHEAVE	MAX.	M.W.L.	B.L.	WEIGHT	SHEAVE	MAX.	M.W.L.	B.L.	WEIGHT
		DIAM.	ROPE	kg	kg	g	DIAM.	ROPE	lb	lb	oz
		mm	mm				in.	in.			
Series 15 - All Purpose											
RF13101	Single block, loop head, black	15	4	150	300	5	5/8	5/32	330	660	0.2
RF13101G	Single block, loop head, grey	15	4	150	300	5	5/8	5/32	330	660	0.2
RF13101R	Single block, loop head, red	15	4	150	300	5	5/8	5/32	330	660	0.2
Series 20 - All Purpose											
RF661	Single block, tube rivet head	20	5	150	450	10	3/4	3/16	330	990	0.4
RF662	Double block, tube rivet head	20	5	300	600	20	3/4	3/16	660	1320	0.7
RF663	Single block, ferrule eye head	20	5	150	450	10	3/4	3/16	330	990	0.4
RF664	Linked blocks, S20 + S20	20	3	150	450	20	3/4	1/8	330	990	0.7
RF666	Single block, loop head	20	5	150	400	10	3/4	3/16	330	880	0.4

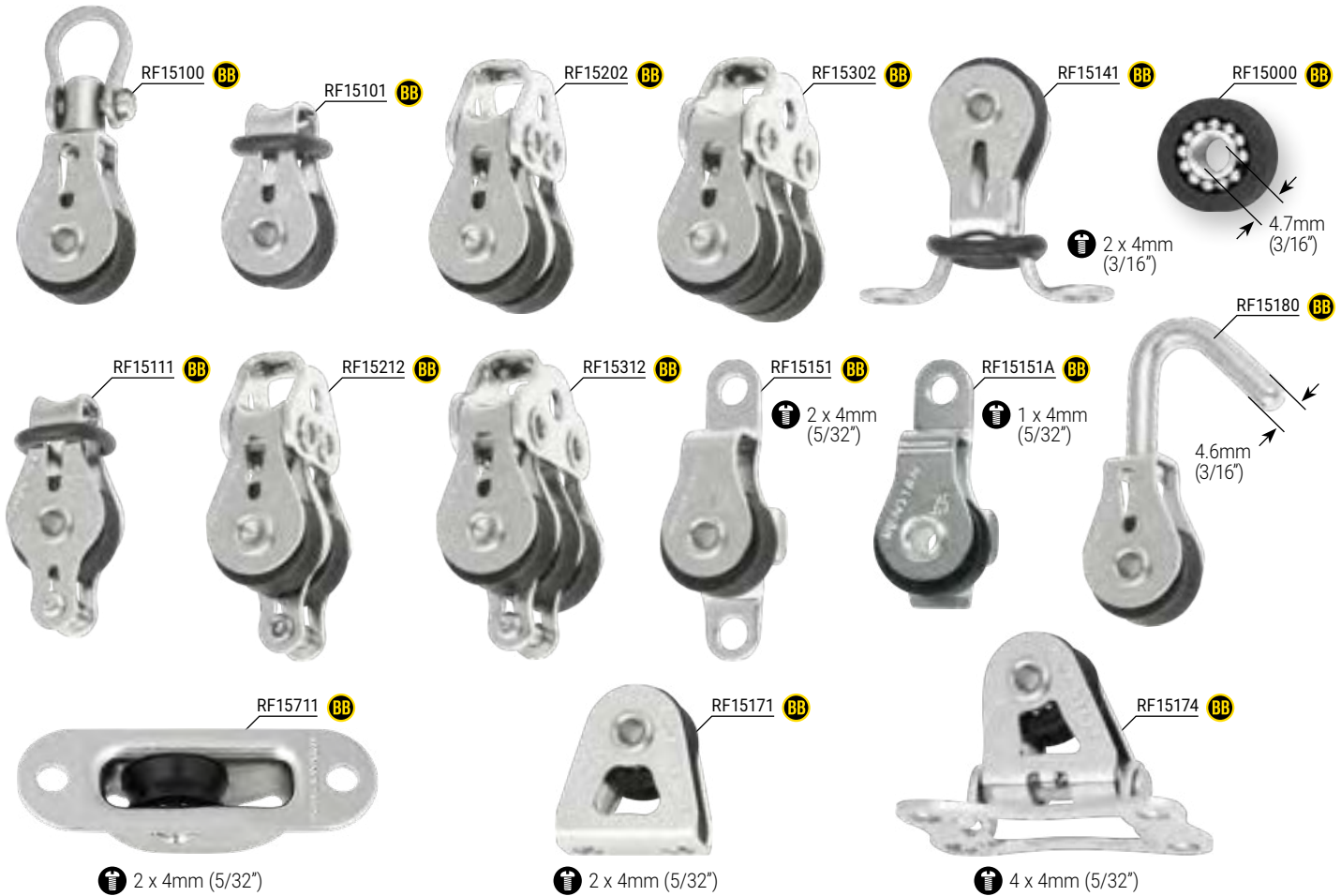

RF133
Suits loop head single blocks

- ✓ Smallest and lightest ball bearing block available.
- ✓ Precision moulded acetal sheave running on stainless steel ball bearings provides high performance and low friction.
- ✓ Single loop head blocks include an O-ring to separate running line from head lashing or fixing.
- ✓ RF15151 & RF15151A cheek blocks feature lateral supports for improved mounting stability.

RF613S - Suits RF15100
RF633S - Suits double and triple blocks

- ✓ RF15174 pivoting lead block has 4-point fastening for load distribution and low profile. Can be mounted without disassembly.
- ✓ RF15711 exit block has a formed single piece housing for maximum strength and minimal rope wear.
- ✓ RF15711 exit block has a flush rivet to minimise cutout dimensions and facilitate installation.

RF1851
Suits loop head single blocks

- ⬆ Dinghy control lines.
- ⬆ Vangs, cunninghams and tweakers.
- ⬆ Shock cord tensioning systems.
- ⬆ Sheaves: UV stabilised acetal.
- ⬆ Ball bearings: Stainless steel.
- ⬆ Cheeks & head fittings: Grade 316 stainless steel.

PRODUCT No.	DESCRIPTION	SHEAVE	MAX.	MAX.	PIN	M.W.L.	B.L.	WEIGHT	SHEAVE	MAX.	MAX.	PIN	M.W.L.	B.L.	WEIGHT
		DIAM.	ROPE	WIRE	DIAM.	kg	kg	g	DIAM.	ROPE	WIRE	DIAM.	lb	lb	oz
		mm	mm	mm	mm				in.	in.	in.	in.			
BB RF15000	Sheave, captive BB, 7mm (9/32") width	15	5	-	-	120	-	2	5/8	3/16	-	-	260	-	0.1
RF15100	Single block, swivel shackle head	15	5	-	3	120	400	11	5/8	3/16	-	1/8	260	880	0.7
RF15101	Single block, loop head	15	5	-	-	120	550	7	5/8	3/16	-	-	260	1210	0.3
RF15111	Single block, bucket, loop head	15	5	-	-	120	550	9	5/8	3/16	-	-	260	1210	0.3
RF15141	Stand-up block	15	5	-	-	120	550	10	5/8	3/16	-	-	260	1210	0.4
RF15151	Cheek block	15	5	-	-	120	550	9	5/8	3/16	-	-	260	1210	0.3
RF15151A	Cheek block, single mounting	15	5	-	-	120	360	9	5/8	3/16	-	-	260	790	0.3
RF15171	Upright lead block	15	5	-	-	120	550	9	5/8	3/16	-	-	260	1210	0.3
RF15174	Pivoting lead block	15	5	-	-	120	350	16	5/8	3/16	-	-	260	770	0.6
RF15180	Single block, swivel hook head	15	5	-	-	100	200	13	5/8	3/16	-	-	220	440	0.4
RF15202	Double block, loop head	15	5	-	-	240	700	23	5/8	3/16	-	-	530	1540	0.8
RF15212	Double block, bucket, loop head	15	5	-	-	240	700	24	5/8	3/16	-	-	530	1540	0.9
RF15302	Triple block, loop head	15	5	-	-	360	850	28	5/8	3/16	-	-	790	1870	1.0
RF15312	Triple block, bucket, loop head	15	5	-	-	360	850	30	5/8	3/16	-	-	790	1870	1.0
RF15711	Exit block	15	5	-	-	120	550	14	5/8	3/16	-	-	260	1210	0.5
RF133	Saddle, 9mm (3/8") internal clearance, suits 2 x 4mm (3/16") fasteners at 27mm (1 1/16") centres	-	-	-	-	-	-	2	-	-	-	-	-	-	0.1
RF613S	Shackle, slotted pin, suits RF15100	-	-	-	3	-	-	3	-	-	-	1/8	-	-	0.1
RF633S	Shackle, slotted pin, suits double & triple blocks	-	-	-	4	-	-	5	-	-	-	5/32	-	-	0.2
RF1851	Shackle, coined pin head, suits loop head single blocks	-	-	-	3	-	-	2	-	-	-	1/8	-	-	0.1





© Topper

 RF25109HL **HHL**

- ✔ Suits up to 4mm (5/32") lashing
- ✔ Ideal for higher load applications

 RF25109 **BB**

- ✔ Suits up to 4mm (5/32") lashing



- ✔ Dyneema® lashing supplied with RF25109HL

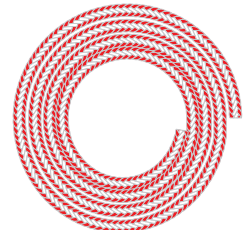

- ✔ Dyneema® lashing supplied with RF25109

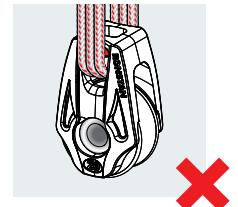
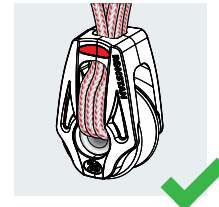

 RF21107 **BB**

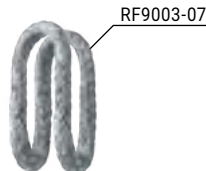
- ✔ RF21107 suits up to 10mm (3/8") webbing or RF9003-07 Dyneema® link.
- ✔ 2-stage ball bearing system.
- ✔ Hollow hub for becket take-off.

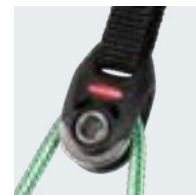

RF9003-07

- ⬆ Control lines.
- ⬆ Leech lines.
- ⬆ Cunninghams.
- ⬆ Cascading vang.
- ⬆ Kite bridles.



RF21107 with webbing attachment

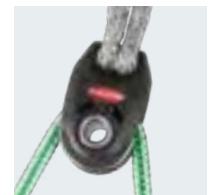

RF21107 with Dyneema® link attachment

- ⚙ BB Sheave: High compression strength acetal.
- ⚙ HHL Sheave and bearing race: Grade 2205 stainless steel.
- ⚙ Load straps (RF21107): Grade 316 stainless steel.
- ⚙ Frame/cheeks: Toughened, glass fibre reinforced nylon.
- ⚙ Ball bearings: Grade 316 stainless steel.

PRODUCT No.	DESCRIPTION	SHEAVE	MAX.	M.W.L.	B.L.	WEIGHT	SHEAVE	MAX.	M.W.L.	B.L.	WEIGHT
		DIAM.	ROPE	kg	kg	g	DIAM.	ROPE	lb	lb	oz
		mm	mm				in.	in.			
BB Ball Bearing											
RF21107	Single block, becket hub, suits 10mm (3/8") webbing	20	5	200	400	14	3/4	3/16	440	880	0.5
RF25109	Single block, becket hub, incl. 750mm (30") x 1.7mm (1/16") diameter, Dyneema® lashing line	20	6	250*	550	9	3/4	1/4	550*	1210	0.3
RF25109HL	Single block, becket hub, incl. 750mm (30") x 1.7mm (1/16") diameter, Dyneema® single braid lashing line	20	6	300*	900	14	3/4	1/4	660*	1980	0.5

Accessories

RF9003-07	Dyneema® link to suit RF21107
-----------	-------------------------------

* Block must be lashed through hub. The supplied lashing line must have three passes through head and hub to achieve rated load. MWL & BL are dependent on the strength of lashing. Knots, splices, stitching will generally have a lower BL than the line itself.



4mm (5/32")



RF498



RF318

Suits RF20101 & RF20111



RF1850S

3mm (1/8") slotted pin, suits loop top single blocks
BL reduced to 500kg (1100lb)

- ✓ Precision moulded acetal sheaves running on stainless steel ball bearings provide high performance & low friction.
- ✓ SP versions feature a Nylatron® sheave suitable for rope and wire.
- ✓ High static and dynamic load capacity.
- ✓ Light weight.
- ✓ Versatile head fittings.

- ✓ Single blocks are available with swivel head or 2 way loop top.
- ✓ Double & triple blocks are supplied with shackle and have a 2 way head that can be fixed at 0° or 90°.
- ✓ Double & triple blocks allow the creation of powerful purchase systems.
- ✓ Upright lead blocks are available in low profile fixed or pivoting options.

- ⬆ Exit blocks minimise friction in lines passing through the deck or exiting masts and booms. Supplied with cover plate, or low profile version with side tabs only.
- ⬆ Linked blocks are used for dinghy barber haulers, cunninghams and spinnaker pole launching systems.

PRODUCT No.	DESCRIPTION	SHEAVE	MAX.	MAX.	PIN	M.W.L.	B.L.	WEIGHT	SHEAVE	MAX.	MAX.	PIN	M.W.L.	B.L.	WEIGHT
		DIAM.	ROPE	WIRE	DIAM.	kg	kg	g	DIAM.	ROPE	WIRE	DIAM.	lb	lb	oz
		mm	mm	mm	mm				in.	in.	in.	in.	lb	lb	oz
BB RF20100	Single block, swivel shackle head	20	6	-	3	250	550	20	3/4	1/4	-	1/8	550	1210	0.7
RF20101	Single block, loop head	20	6	-	-	250	550	16	3/4	1/4	-	-	550	1210	0.6
RF20111	Single block, becket, loop head	20	6	-	-	250	550	18	3/4	1/4	-	-	550	1210	0.6
RF20141	Stand-up block	20	6	-	-	250	550	20	3/4	1/4	-	-	550	1210	0.7
RF20202	Double block, 2-axis shackle head	20	6	-	4	350	700	42	3/4	1/4	-	5/32	770	1540	1.5
RF20212	Double block, becket, 2-axis shackle head	20	6	-	4	350	700	44	3/4	1/4	-	5/32	770	1540	1.6
RF20281	Double block, in-line	20	6	-	-	250	550	28	3/4	1/4	-	-	550	1210	1.0
RF20284	Linked blocks, S20 & S20	20	6	-	-	250	550	30	3/4	1/4	-	-	550	1210	1.1
RF20302	Triple block, 2-axis shackle head	20	6	-	4	400	850	62	3/4	1/4	-	5/32	880	1870	2.2
RF20312	Triple block, becket, 2-axis shackle head	20	6	-	4	400	850	64	3/4	1/4	-	5/32	880	1870	2.3
RF20332	Triple block, becket, cam cleat, 2-axis shackle head	20	6	-	4	400*	850	122	3/4	1/4	-	5/32	880*	1870	4.3
SP RF20101HL	Single block, loop head	20	6	3	-	275	550	14	3/4	1/4	1/8	-	610	1210	0.5

* Line load through cleat not to exceed 125kg (275lb).

RF613S
 3mm (1/8") pin, suits RF20100

RF615
 4mm (5/32") pin, suits double & triple blocks

- ✓ Cheek block RF20151 has through-hub mounting for maximum strength.
- ✓ Cheek block RF20151A suits pop rivet mounting.
- ✓ RF20180 features a low profile swivelling hook for quick and easy attachment. Suits rope, stainless steel and webbing attachment points.

- ⬆ Dinghy control lines and vang.
- ⬆ Cunninghams.
- ⬆ Traveller controls.

- ⚙ BB sheaves: UV stabilised acetal.
- ⚙ SP sheaves: Self-lubricating Nylatron®.
- ⚙ Ball bearings: Stainless steel.
- ⚙ Load straps, head fittings & hook (RF20180): Grade 316 stainless steel.

PRODUCT No.	DESCRIPTION	SHEAVE	MAX.	MAX.	PIN	M.W.L.	B.L.	WEIGHT	SHEAVE	MAX.	MAX.	PIN	M.W.L.	B.L.	WEIGHT
		DIAM.	ROPE	WIRE	DIAM.	kg	kg	g	DIAM.	ROPE	WIRE	DIAM.	lb	lb	oz
		mm	mm	mm	mm				in.	in.	in.	in.	lb	lb	oz
BB Ball Bearing															
RF20151	Cheek block	20	6	-	-	250	550	14	3/4	1/4	-	-	550	1210	0.5
RF20151A	Cheek block, rivet mount	20	6	-	-	200	550	17	3/4	1/4	-	-	440	1210	0.6
RF20171	Upright lead block	20	6	-	-	250	550	18	3/4	1/4	-	-	550	1210	0.6
RF20174	Pivoting lead block	20	6	-	-	250	550	30	3/4	1/4	-	-	550	1210	1.1
RF20175	Pivoting lead block, cleat	20	6	-	-	150*	300	79	3/4	1/4	-	-	330*	660	2.8
RF20180	Single block, swivel hook head	20	6	-	-	100	200	21	3/4	1/4	-	-	220	440	0.7
RF20184	Single block, loop mount	20	6	-	-	250	550	22	3/4	1/4	-	-	550	1210	0.8
RF20711	Exit block, cover plate	20	6	-	-	250	1000	22	3/4	1/4	-	-	550	2200	0.8
RF20711A	Exit block, side tabs	20	6	-	-	250	1000	22	3/4	1/4	-	-	550	2200	0.8
SP Special Purpose - Nylatron® Sheave															
RF20000HL	Sheave, Nylatron®	20	6	3	-	-	-	2	3/4	1/4	1/8	-	-	-	0.1
RF20711HL	Exit block, cover plate	20	6	3	-	275	1000	22	3/4	1/4	1/8	-	610	2200	0.8
RF20711AHL	Exit block, side tabs	20	6	3	-	275	1000	22	3/4	1/4	1/8	-	610	2200	0.8

* Line load through cleat not to exceed 125kg (275lb).

SERIES 25

RF575
Sheave profile

SERIES 30

RF469A
Cheek plates twist to open block

✔ Simple, versatile and economical blocks that have many uses.

✔ Lightweight, durable construction.

✔ Stainless steel cheeks and acetal sheaves ensure long service life with virtually no maintenance required.

⚙ Vang, cunningham and trapeze retriever systems on dinghies.

⚙ Leech line tackles and bunk adjusters on larger yachts.

⚙ Sheaves: UV stabilised acetal.

⚙ Cheeks & head fittings: Grade 316 stainless steel.

PRODUCT No.	DESCRIPTION	SHEAVE DIAM.	MAX. ROPE	PIN/EYE	M.W.L.	B.L.	WEIGHT	SHEAVE DIAM.	MAX. ROPE	PIN/EYE	M.W.L.	B.L.	WEIGHT
		mm	mm	mm	kg	kg	g	in.	in.	in.	lb	lb	oz
Series 25 - AP All Purpose													
RF571	Single block, loop head	25	6	-	300	600	15	1	1/4	-	660	1320	0.5
RF572	Single block, becket, loop head	25	6	-	300	600	20	1	1/4	-	660	1320	0.7
RF573	Single block, swivel shackle head	25	6	4	150	300	20	1	1/4	5/32	330	660	0.7
RF575	Single block, loop head, sheave suits flat webbing	25	6*	10	300	600	20	1	1/4*	3/8	660	1320	0.7
RF2332	Single block, swivel ring head	25	6	10	300	600	20	1	1/4	3/8	660	1320	0.7
Series 30 - AP All Purpose													
RF280	Single block, loop head	30	8	-	300	600	20	1 1/8	5/16	-	660	1320	0.7
RF443	Single block, swivel ring head	30	10	13	250	500	44	1 1/8	3/8	1/2	550	1100	1.6
RF467	Single block, swivel shackle head	30	10	5	250	500	50	1 1/8	3/8	3/16	550	1100	1.8
RF469	Single block, ferrule eye head	30	10	10	300	600	40	1 1/8	3/8	3/8	660	1320	1.4
RF469A	Single block, snatch	30	10	10	300	600	40	1 1/8	3/8	3/8	660	1320	1.4
RF470	Single block, becket, ferrule eye head	30	10	10	300	600	45	1 1/8	3/8	3/8	660	1320	1.6
RF567	Single block, becket, swivel shackle head	30	10	5	250	500	55	1 1/8	3/8	3/16	550	1100	1.9
RF681	Single block, becket, loop head	30	8	-	300	600	25	1 1/8	5/16	-	660	1320	0.9

* Sheave designed to take 5.5mm flat webbing.

SERIES 25

SERIES 30

2 x 4mm (5/32")

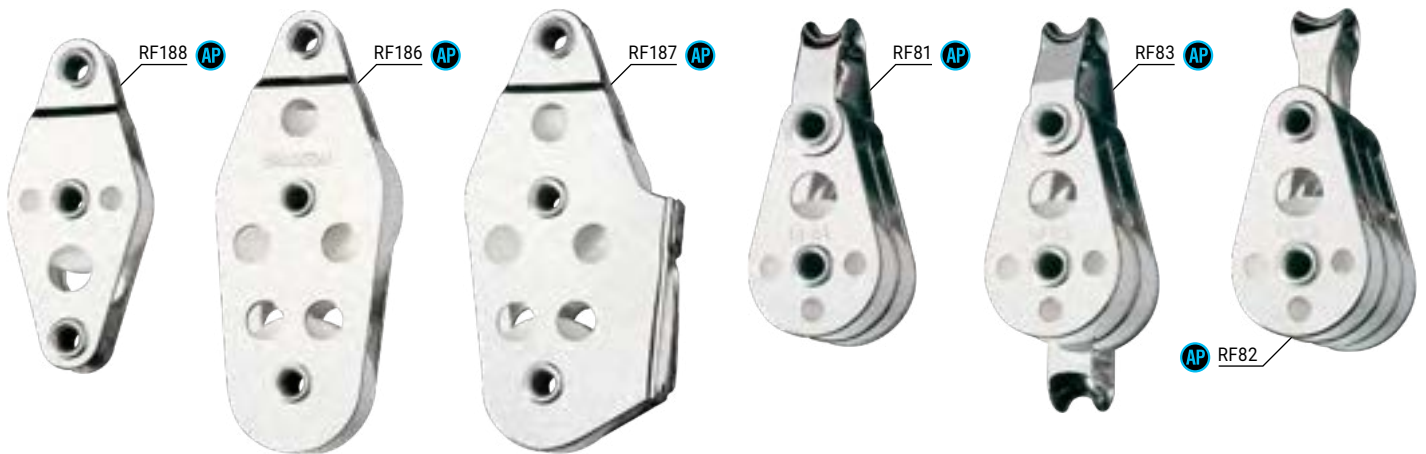
SERIES 30

RF807
4.8mm (3/16") pin, suits single and fiddle blocks

- ✔ Simple, versatile and economical blocks that have many uses.
- ✔ Lightweight, durable construction.
- ✔ Stainless steel cheeks and acetal sheaves ensure long service life with virtually no maintenance required.
- ✔ Hollow rivets accept fixing screws, shackles or can be used as a becket for extra purchase.
- ✔ V-jam cleats allow fast secure cleating of control lines.
- ✔ Vang, cunningham and trapeze retriever systems on dinghies.
- ✔ Leech line tackles and bunk adjusters on larger yachts.
- ✔ Sheaves: UV stabilised acetal.
- ✔ Cheeks: Grade 316 stainless steel.

PRODUCT No.	DESCRIPTION	SHEAVE	MAX.	M.W.L.	B.L.	WEIGHT	SHEAVE	MAX.	M.W.L.	B.L.	WEIGHT
		DIAM.	ROPE	kg	kg	g	DIAM.	ROPE	lb	lb	oz
		mm	mm				in.	in.			
Series 25 - All Purpose											
RF341	Single block, becket, v-jam cleat, removable pin head	25	5	225	450	30	1	3/16	500	990	1.1
RF343	Triple block, becket, v-jam cleat, loop head	25	5	500	1000	75	1	3/16	1100	2200	2.6
RF2335	Single block, narrow, tube rivet head	25	5	175	350	65	1	3/16	390	770	2.3
Series 30 - All Purpose											
RF81	Double block, loop head	30	8	300	600	40	1 1/8	5/16	660	1320	1.4
RF82	Triple block, loop head	30	8	550	1100	60	1 1/8	5/16	1210	2420	2.1
RF83	Double block, becket, loop head	30	8	300	600	50	1 1/8	5/16	660	1320	1.8
RF185	Single block, tube rivet head	30	8	300	900	20	1 1/8	5/16	660	1980	0.7
RF186	Fiddle block, tube rivet head	30 + 40	8	300	600	50	1 1/8 + 1 9/16	5/16	660	1320	1.8
RF187	Fiddle block, v-jam cleat, tube rivet head	30 + 40	8	300	600	60	1 1/8 + 1 9/16	5/16	660	1320	2.1
RF188	Single block, becket, tube rivet head	30	8	300	600	35	1 1/8	5/16	660	1320	1.2
RF285	Cheek block, curved base	30	8	300	600	42	1 1/8	5/16	660	1320	1.5
RF417	Double block, tube rivet head	30	8	450	1300	40	1 1/8	5/16	990	2860	1.4



Ideal for high load applications such as halyards, cascading vang, backstays, outhauls and cunningham systems



Block must be lashed through central hub. MWL and BL is dependent on the strength of the lashing.



RF9004-11
Suits single blocks as a lashing stop.
BL reduced to 1300kg (2860lb)



RF614
Use with RF9004-09 for attachment option for RF35109HL. BL reduced to 1300kg (2860lb)



RF134
RF134A (countersunk holes)



RF323
Suits RF35100, RF35100D



RF1850S-2 (2 pack)
Suits RF35101 in either direction
BL reduced to 500kg (1100lb)

- ✓ RF35101 and RF35100 - Ultra-low profile through-sheave becket.
- ✓ 2-stage ball bearing system.
- ✓ RF35101 accepts RF1850S shackle in both orientations to create a conventional loop top block.
- ✓ SP versions feature a Nylatron® sheave suitable for both rope and wire.

- ✓ RF35109HL features class leading dynamic and static load ratings for a 30mm block. Refer www.ronstan.com for lashing instructions.
- ⚙ Mainsheet systems and spinnaker sheets on dinghies to 5m (16ft).
- ⚙ Halyard, vang and backstay applications on boats to 5m (16ft).
- ⚙ Control line applications on larger yachts.

- ⚙ BB sheaves and balls: High compression strength acetal.
- ⚙ SP sheaves: Self-lubricating Nylatron®.
- ⚙ HHL sheave, bearing race and balls: Grade 2205 stainless steel.
- ⚙ Frame/cheeks: Glass fibre reinforced nylon.
- ⚙ Soft link: UV stabilised, multi-strand SK78 Dyneema®.

PRODUCT No.	DESCRIPTION	SHEAVE DIAM.	MAX. ROPE	PIN DIAM.	M.W.L.	B.L.	WEIGHT	SHEAVE DIAM.	MAX. ROPE	PIN DIAM.	M.W.L.	B.L.	WEIGHT
		mm	mm	mm	kg	kg	g	in.	in.	in.	lb	lb	oz
BB Ball Bearing													
RF35100	Single block, becket hub, swivel shackle head	30	8	4	300	600	32	1 3/16	5/16	5/32	660	1320	1.1
RF35101	Single block, becket hub, lashing head	30	8	-	300	600	22	1 3/16	5/16	-	660	1320	0.8
RF35202	Double block, non-swivel shackle head	30	8	-	450	900	56	1 3/16	5/16	-	990	1980	2.0
RF35212	Double block, becket*1, non-swivel shackle head	30	8	-	450*2	900	57	1 3/16	5/16	-	990*2	1980	2.0
RF35302	Triple block, non-swivel shackle head	30	8	-	550	1100	79	1 3/16	5/16	-	1210	2430	2.8
RF35312	Triple block, becket*1, non-swivel shackle head	30	8	-	550*3	1100	81	1 3/16	5/16	-	1210*3	2430	2.9
HHL High Grade Stainless Steel Sheave													
RF35109HL	Single block HHL, lashing hub and becket option	30	8	-	550*4	1650*4	42	1 3/16	5/16	-	1210*4	3630*4	15
SP Special Purpose - Nylatron® Sheave													
RF35100D	Single block, becket hub, swivel shackle head	30	8	4	300	600	31	1 3/16	5/16	5/32	660	1320	1.1
RF35101D	Single block, becket hub, lashing head	30	8	-	300	600	21	1 3/16	5/16	-	660	1320	0.7

*1 Becket suits up to 6mm (1/4") line. For lines above 6mm (1/4") use an additional Dyneema® link (sold separately)

*2 Total block load. Load on becket not to exceed 25% of block load. i.e. MWL 140kg (310lb), BL 280kg (610lb). Suitable for 4:1 system at rated block load.

*3 Total block load. Load on becket not to exceed 25% of block load. i.e. MWL 140kg (310lb), BL 280kg (610lb). Suitable for 6:1 system at rated block load.

*4 Both the MWL and BL are dependent on the strength of the line used to lash the block through the central hub.



- ☑ RF35322 & RF35332 - Composite C-Cleat™ and fairlead.
- ☑ RF35151 - Base suits curved mounting surface.
- ☑ RF35286 - Stainless steel ring, 40mm (1 1/2") OD, 5mm (3/16") diameter material.

- ⚙ Mainsheet systems and spinnaker sheets on dinghies to 5m (16ft).
- ⚙ Halyard, vang and backstay applications on boats to 5m (16ft).
- ⚙ Control line applications on larger yachts.
- ⚙ Primary lead blocks on dinghies and catamarans.

- ⚙ Sheaves: High compression strength acetal.
- ⚙ Ball bearings: High compression strength acetal.
- ⚙ Frame/cheeks: Toughened, glass fibre reinforced nylon.
- ⚙ Head fittings & hubs: Grade 316 stainless steel.

PRODUCT No.	DESCRIPTION	SHEAVE DIAM.	MAX. ROPE	PIN DIAM.	M.W.L.	B.L.	WEIGHT	SHEAVE DIAM.	MAX. ROPE	PIN DIAM.	M.W.L.	B.L.	WEIGHT
		mm	mm	mm	kg	kg	g	in.	in.	in.	lb	lb	oz
BB RF35000	Sheave, captive BB, 11mm (7/16") width	30	8	-	300	-	6	1 3/16	5/16	-	660	-	0.2
RF35100A	Single block, becket hub, slotted head post, swivel shackle head	30	8	4	300	600	31	1 3/16	5/16	5/32	660	1320	1.1
RF35140	Stand-up block, swivel head	30	8	-	300	600	33	1 3/16	5/16	-	660	1320	1.2
RF35141	Stand-up block, non-swivel head	30	8	-	250	500	36	1 3/16	5/16	-	550	1100	1.3
RF35151	Cheek block	30	8	-	300	600	21	1 3/16	5/16	-	660	1320	0.7
RF35284	Linked blocks, S30 & S30	30+30	8	-	300	600	46	1 3/16+1 3/16	5/16	-	660	1320	1.6
RF35286	Clew ring blocks	30	8	-	300	600	63	1 3/16	5/16	-	660	1320	2.2
RF35322	Triple block, cleat, non-swivel shackle head	30	8	-	550 ^{*3}	1100	130	1 3/16	5/16	-	1210 ^{*3}	2430	4.6
RF35332	Triple block, becket ^{*1} , cleat, non-swivel shackle head	30	8	-	550 ^{*2&3}	1100	132	1 3/16	5/16	-	1210 ^{*2&3}	2430	4.7

Spare Parts & Conversion Accessories
Blocks suited:

RF9003-07 Dyneema® link to suit S30 double & triple Orbit Blocks™ Suits RF35202, RF35212, RF35302, RF35312, RF35322, RF35332

*1 Becket suits up to 6mm (1/4") line. For lines above 6mm (1/4") use an additional Dyneema® link (sold separately).

*2 Total block load. Load on becket not to exceed 25% of block load. i.e. MWL 140kg (310lb), BL 280kg (610lb). Suitable for 6:1 system at rated block load.

*3 Line load through cleat not to exceed 125kg (280lb).

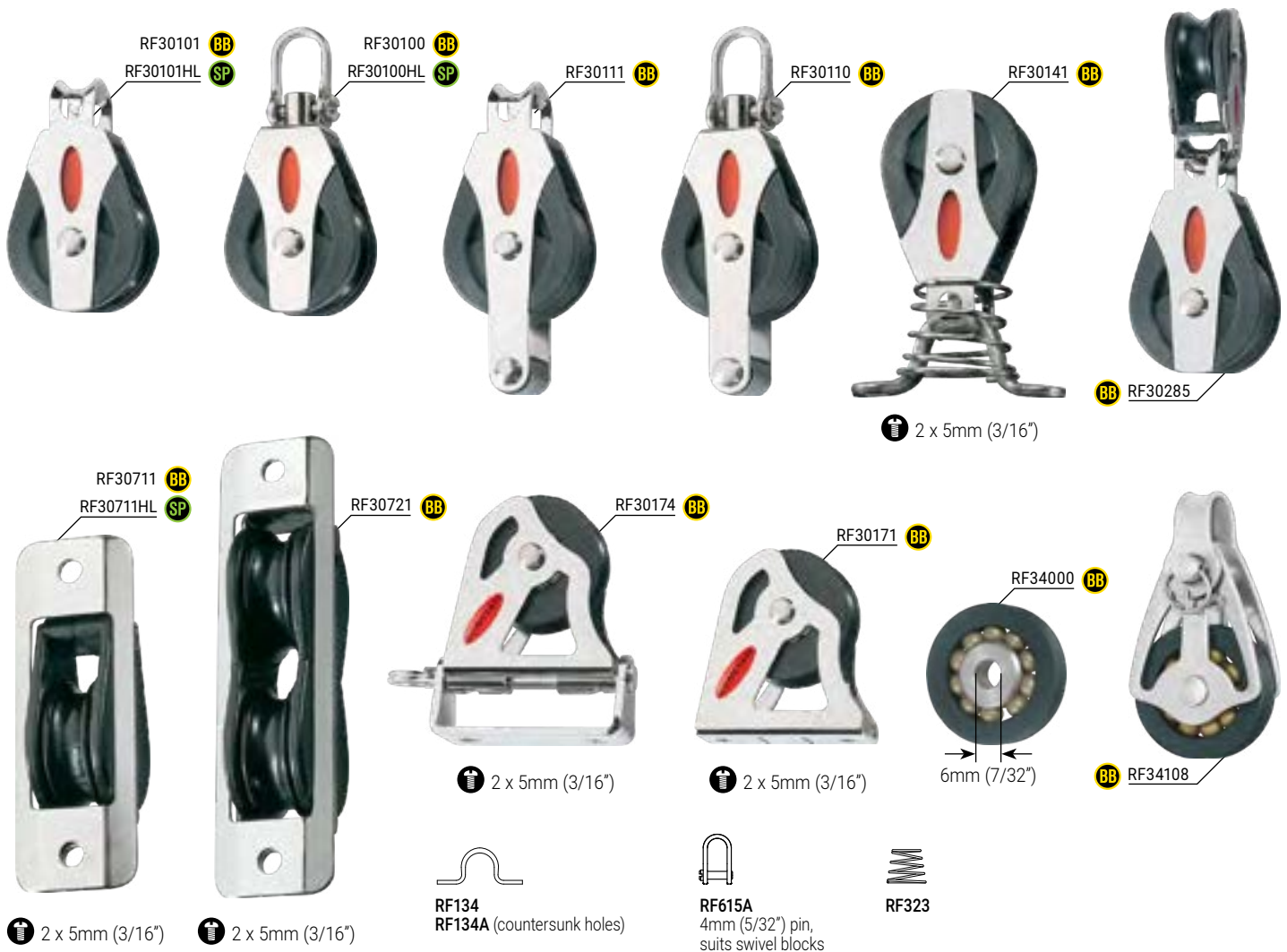

- ⬆️ Linked blocks are used for barber haulers, cunninghams and spinnaker pole launching systems.
- ⬆️ Primary lead blocks on dinghies and catamarans.
- ⬆️ Control lines on larger yachts.
- ⬆️ Exit blocks minimise friction in lines passing through the deck or exiting masts and booms.

- ⬆️ Upright lead blocks are a low profile solution for leading halyards or other rig and sail controls back to cleats or jammers. Pivoting version suits controls that need to be trimmed from either side of the boat.
- ⬆️ BB sheaves: UV stabilised acetal.
- ⬆️ SP sheaves: Self-lubricating Nylatron®.

- ⬆️ Ball bearings: Acetal (RF34000 & RF34108 use Torlon® ball bearings).
- ⬆️ Cheeks: Impact modified, fibre reinforced and UV stabilised nylon.
- ⬆️ Load straps & head fittings: Grade 316 stainless steel.

PRODUCT No.	DESCRIPTION	SHEAVE	MAX.	MAX.	PIN	M.W.L.	B.L.	WEIGHT	SHEAVE	MAX.	MAX.	PIN	M.W.L.	B.L.	WEIGHT
		DIAM.	ROPE	WIRE	DIAM.				DIAM.	ROPE	WIRE	DIAM.			
		mm	mm	mm	mm	kg	kg	g	in.	in.	in.	in.	lb	lb	oz
BB Ball Bearing															
RF30100	Single block, swivel shackle head	30	8	-	4	300	750	34	1 3/16	5/16	-	5/32	660	1650	1.2
RF30101	Single block, loop head	30	8	-	-	300	750	28	1 3/16	5/16	-	-	660	1650	1.0
RF30110	Single block, becket, swivel shackle head	30	8	-	4	300	750	40	1 3/16	5/16	-	5/32	660	1650	1.4
RF30111	Single block, becket, loop head	30	8	-	-	300	750	34	1 3/16	5/16	-	-	660	1650	1.2
RF30141	Stand-up block	30	8	-	-	300	750	38	1 3/16	5/16	-	-	660	1650	1.3
RF30171	Upright lead block	30	8	-	-	300	750	30	1 3/16	5/16	-	-	660	1650	1.1
RF30174	Pivoting lead block	30	8	-	-	300	650	50	1 3/16	5/16	-	-	660	1430	1.8
RF30285	Linked blocks, S30 & S20	30+20	8+6	-	-	250	550	44	1 3/16+3/4	5/16+1/4	-	-	550	1210	1.6
RF30711	Single exit block	30	8	-	-	300	750	35	1 3/16	5/16	-	-	660	1650	1.2
RF30721	Double exit block	30	8	-	-	300	750	60	1 3/16	5/16	-	-	660	1650	2.1
RF34000	Sheave, alloy, Torlon® balls	30	5	-	-	165	330	10	1 3/16	3/16	-	-	360	730	0.4
RF34108	Single, removable loop head, alloy sheave, Torlon® balls	30	5	-	6	165	675	36	1 3/16	3/16	-	7/32	360	1490	1.3
SP Special Purpose - Nylatron® Sheave															
RF30100HL	Single block, swivel shackle head	30	8	3	4	375	750	28	1 3/16	5/16	1/8	5/32	830	1650	1.0
RF30101HL	Single block, loop head	30	8	3	-	375	750	28	1 3/16	5/16	1/8	-	830	1650	1.0
RF30711HL	Single exit block	30	8	3	-	300	750	43	1 3/16	5/16	1/8	-	660	1650	1.5





© Seascope / Ana Šutej



- ☑ 2-stage ball bearing system.
- ☑ Single inner cheeks on doubles and triples for reduced weight and bulk.
- ☑ RF45110, RF45111 & RF45140 - Ultra-low profile integrated becket.

- ☑ RF45110 - Stainless steel shackle head for unlimited block rotation, and compatibility with sharp fixing points.
- ☑ Mainsheet systems and spinnaker sheets on dinghies to 5m (16ft).

- ☑ Halyard, vang and backstay applications on boats to 8m (26ft).
- ☑ Control line applications on larger yachts.
- ☑ Rope link: UV stabilised, multi-strand SK78 Dyneema®.

PRODUCT No.	DESCRIPTION	SHEAVE DIAM.	MAX. ROPE	PIN DIAM.	M.W.L.	B.L.	WEIGHT	SHEAVE DIAM.	MAX. ROPE	PIN DIAM.	M.W.L.	B.L.	WEIGHT
		mm	mm	mm	kg	kg	g	in.	in.	in.	lb	lb	oz
BB Ball Bearing													
RF45101	Single block, Dyneema® link head	40	9	-	325	700	33	1 9/16	5/16	-	715	1540	1.2
RF45110	Single block, becket, swivel shackle head	40	9	4	325 ^{*1}	650	44	1 9/16	5/16	5/32	715 ^{*1}	1430	1.6
RF45111	Single block, becket, Dyneema® link head	40	9	-	325 ^{*1}	700	36	1 9/16	5/16	-	715 ^{*1}	1540	1.3
RF45130	Single block, becket, adjustable cleat, swivel shackle head	40	9	4	325 ^{*1&2}	650	105	1 9/16	5/16	5/32	715 ^{*1&2}	1430	3.7
RF45140	Stand-up block, becket, swivel head	40	9	-	325	650	54	1 9/16	5/16	-	715	1430	1.9
RF45201	Double block, Dyneema® link head	40	9	-	500	1000	67	1 9/16	5/16	-	1100	2200	2.4
Accessories													
RF4	Swivel shackle base. Suits Series 40 & 55 Orbit Block™ Dyneema® links. 4.8mm (3/16") diameter pin	-	-	-	250	500	30	-	-	-	550	1100	1.1
RF2454	Stand-up base, suits S40 Orbit Blocks™ - boot & saddle	-	-	-	320	700	11	-	-	-	715	1540	0.4
RF2454B	Stand-up boot, suits S40 Orbit Blocks™ - boot only	-	-	-	-	-	6	-	-	-	-	-	0.2

*1 Total block load. Becket MWL 125kg (275lb), BL 250kg (550lb). Suitable for 3:1 system at rated block load.

*2 Line load through cleat not to exceed 125kg (275lb).



© Michael Chittenden



- ☑ RF45151 - Base suits flat or curved mounting surface.
- ☑ RF45511 & RF45531 - Lightweight integrated Dyneema® becket link.
- ☑ RF45130, RF45521 & RF45531 - Composite C-Cleat™ and fairlead.
- ⚙ Spinnaker sheets on dinghies, sportsboats and small keelboats to 5m (16ft).
- ⚙ Sheave: Carbon fibre reinforced, PTFE impregnated nylon.
- ⚙ Stage 2 bearing: Glass fibre reinforced, MoS₂ impregnated nylon.
- ⚙ Frame/cheeks: Toughened, glass fibre reinforced nylon.
- ⚙ Ball bearings: High compression strength acetal.

PRODUCT No.	DESCRIPTION	SHEAVE	MAX.	M.W.L.	B.L.	WEIGHT	SHEAVE	MAX.	M.W.L.	B.L.	WEIGHT
		DIAM.	ROPE	kg	kg	g	DIAM.	ROPE	lb	lb	oz
		mm	mm				in.	in.			
BB RF45151	Cheek block	40	9	325	700	32	1 9/16	5/16	715	1540	1.1
RF45501	Fiddle block ^{*3} , Dyneema® link head	40 + 22	9	325	700	47	1 9/16 + 7/8	5/16	715	1540	1.7
RF45511	Fiddle block ^{*3} , becket, Dyneema® link head	40 + 22	9	325 ^{*1}	700	48	1 9/16 + 7/8	5/16	715 ^{*1}	1540	1.7
RF45521	Fiddle block ^{*3} , adjustable cleat, Dyneema® link head	40 + 22	9	325 ^{*2}	700	108	1 9/16 + 7/8	5/16	715 ^{*2}	1540	3.8
RF45531	Fiddle block ^{*3} , becket, adjustable cleat, Dyneema® link head	40 + 22	9	325 ^{*1&2}	700	109	1 9/16 + 7/8	5/16	715 ^{*1&2}	1540	3.8

*1 Total block load. Becket MWL 125kg (275lb), BL 250kg (550lb). Suitable for 3:1 system at rated block load.
 *2 Line load through cleat not to exceed 125kg (275lb).
 *3 Small fiddle block sheave has a high load full contact bearing (i.e. not ball bearing). Main sheave has 2-stage, ball bearing.

RF46100 **BB**RF46100M **BB**RF46101 **BB**RF46102 **BB**

Stainless steel swivel shackle head



Superior holding power

RF46151 **BB**

2 x 4mm (5/32")

RF46151A **BB**

2 x 4mm (5/32")



RF40001



RF40002



RF9003-07



RF9004-08



RF4

2 x 5mm (3/16")

RF2454
RF2454B

2 x 5mm (3/16")

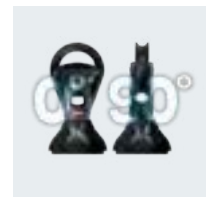

0° or 90° stand-up

RF615
4mm (5/32") pin, suits RF46100 & RF46100M

- ✔ RF46100 & RF46100M - Stainless steel swivel shackle head for unlimited block rotation, and compatibility with sharp fixing points.
- ⬆ Dinghy mainsheet systems.
- ⬆ Spinnaker and jib sheets on dinghies.

- ⬆ Mainsheet fine tune systems on sportsboats & small keelboats using RF6 or RF7 mainsheet swivel cleat unit.
- ⬆ Control line applications on larger yachts.
- ⬆ Shackle & head fitting (RF46100 & RF46100M): Grade 316 stainless steel.

- ⬆ Sheave: Anodised aluminium.
- ⬆ Ball bearings: High compression strength acetal.
- ⬆ Frame/cheeks: Toughened, glass fibre reinforced nylon.
- ⬆ Rope link: UV stabilised, multi-strand SK78 Dyneema®.

PRODUCT No.	DESCRIPTION	SHEAVE	MAX.	PIN	M.W.L.	B.L.	WEIGHT	SHEAVE	MAX.	PIN	M.W.L.	B.L.	WEIGHT
		DIAM.	ROPE	DIAM.	kg	kg	g	DIAM.	ROPE	DIAM.	lb	lb	oz
		mm	mm	mm				in.	in.	in.	lb	lb	oz
BB RF46100	Single block, auto, swivel shackle head	40	9	4	175	500	38	1 9/16	5/16	5/32	385	1100	1.3
RF46100M	Single block, manual, swivel shackle head	40	9	4	175	500	38	1 9/16	5/16	5/32	385	1100	1.3
RF46101	Single block, auto, Dyneema® link head	40	9	-	175	500	35	1 9/16	5/16	-	385	1100	1.2
RF46102	Single block, manual, Dyneema® link head	40	9	-	175	500	35	1 9/16	5/16	-	385	1100	1.2
RF46151	Cheek block, clockwise, auto	40	9	-	175	500	36	1 9/16	5/16	-	385	1100	1.3
RF46151A	Cheek block, anti-clockwise, auto	40	9	-	175	500	36	1 9/16	5/16	-	385	1100	1.3

PRODUCT No.	DESCRIPTION	M.W.L.	B.L.	WEIGHT	M.W.L.	B.L.	WEIGHT
		kg	kg	g	lb	lb	oz
Accessories							
RF4	Swivel shackle base. Suits Series 40 & 55 Orbit Block™ Dyneema® links. 4.8mm (3/16") diameter pin	250	500	30	550	1100	1.1
RF2454	Stand-up base, suits S40 Orbit Blocks™ - boot & saddle	325	700	11	715	1540	0.4
RF2454B	Stand-up boot, suits S40 Orbit Blocks™ - boot only	-	-	6	-	-	0.2

Spare Parts - Dyneema® Links

RF9003-07	S40 single & fiddle Orbit Blocks™	RF45101, RF45111, RF45501, RF45511, RF45521, RF45531, RF46101, RF46102
RF9004-08	S40 double & triple Orbit Blocks™	RF45201

Spare Parts - Link Retainer Clips

RF40001	S40 single & fiddle Orbit Blocks™ (2 pack)	RF45101, RF45111, RF45501, RF45511, RF45521, RF45531, RF46101, RF46102
RF40002	S40 double & triple Orbit Blocks™ (2 pack)	RF45201



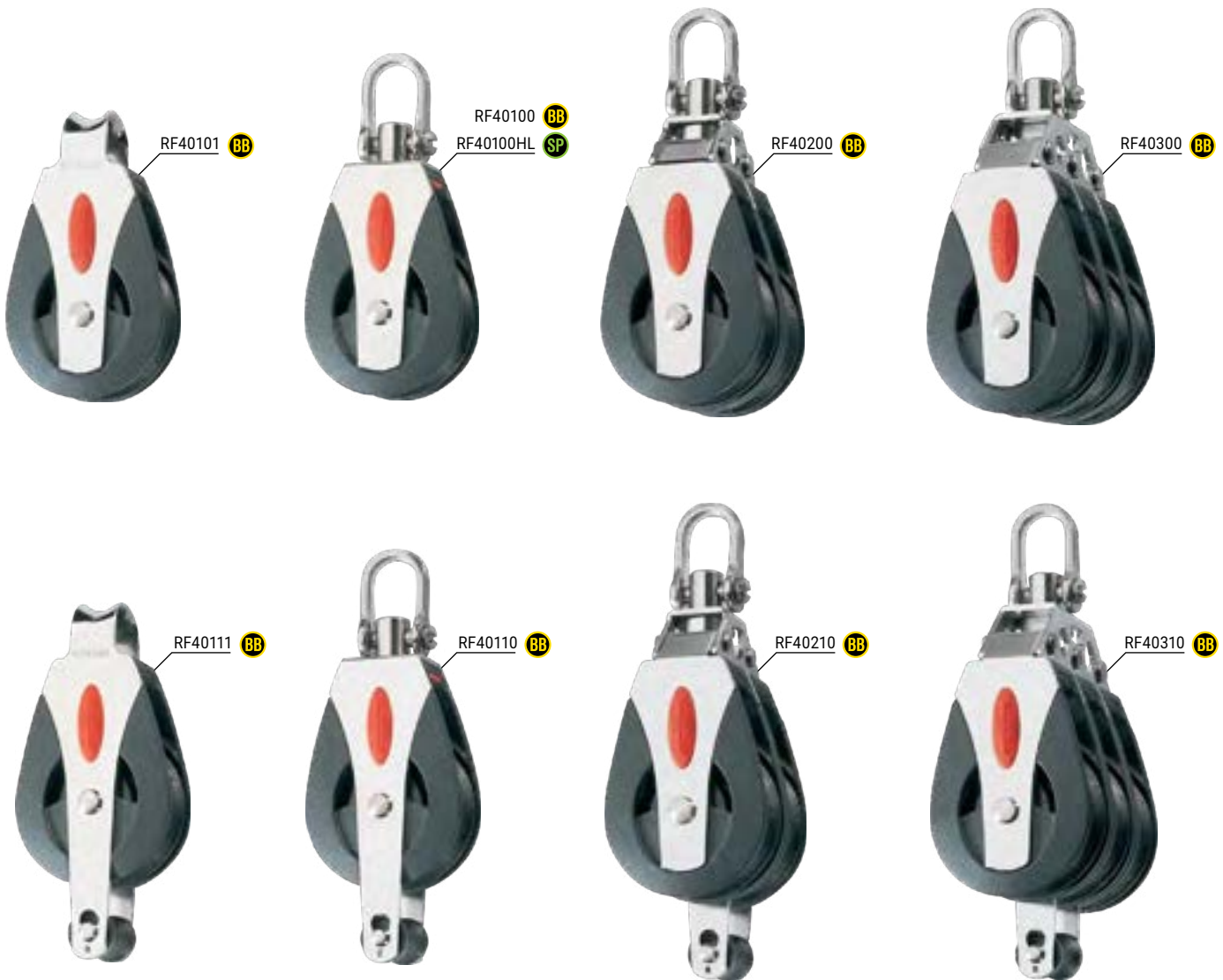

RF150
4.8mm
(3/16") pin



RF134
RF134A (countersunk holes)



RF321
Suits shackle
head blocks



RF2454
Suits loop
head blocks

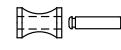

RF41010
Snap-in keyhole
becket pin

- ✓ 2-stage ball bearing system.
- ✓ Light weight.
- ✓ Removable becket pins allow lines to be spliced prior to fitting and are locked into position without the use of split rings or tools.

- ✓ Cheek cut-outs for easy bearing maintenance.
- ✓ SP versions feature a Nylatron® sheave suitable for both rope and wire.
- ✓ Captive Lock™ universal head can be fixed at 0° or 90°, or left free to swivel on single blocks.

- ✓ Double & triple blocks have a swivel shackle head for full 360° rotation.

PRODUCT No.	DESCRIPTION	SHEAVE	MAX.	MAX.	PIN	M.W.L.	B.L.	WEIGHT	SHEAVE	MAX.	MAX.	PIN	M.W.L.	B.L.	WEIGHT
		DIAM.	ROPE	WIRE	DIAM.	kg	kg	g	DIAM.	ROPE	WIRE	DIAM.	lb	lb	oz
		mm	mm	mm	mm				in.	in.	in.	in.	lb	lb	oz
BB Ball Bearing															
RF40100	Single block, universal head	40	10	-	5	350	1000	70	1 9/16	3/8	-	3/16	770	2200	2.5
RF40101	Single block, loop head	40	10	-	-	350	1000	53	1 9/16	3/8	-	-	770	2200	1.9
RF40110	Single block, becket, universal head	40	10	-	5	350	1000	79	1 9/16	3/8	-	3/16	770	2200	2.8
RF40111	Single block, becket, loop head	40	10	-	-	350	1000	60	1 9/16	3/8	-	-	770	2200	2.1
RF40200	Double block, swivel shackle head (non-locking)	40	10	-	5	500	1200	134	1 9/16	3/8	-	3/16	1100	2650	4.7
RF40210	Double block, becket, swivel shackle head (non-locking)	40	10	-	5	500	1200	142	1 9/16	3/8	-	3/16	1100	2650	5.0
RF40300	Triple block, swivel shackle head (non-locking)	40	10	-	5	600	1400	194	1 9/16	3/8	-	3/16	1320	3090	6.9
RF40310	Triple block, becket, swivel shackle head (non-locking)	40	10	-	5	600	1400	209	1 9/16	3/8	-	3/16	1320	3090	7.4
SP Special Purpose - Nylatron® Sheave															
RF40100HL	Single block, universal head	40	10	4	5	500	1000	69	1 9/16	3/8	5/32	3/16	1100	2200	2.4



RF150
4.8mm (3/16") pin, suits single and fiddle blocks

RF41010
snap-in keyhole becket pin

- Snap shackle adapters suit single & fiddle blocks.
- Low profile stand-up block has swivel head post to allow full articulation and rotation.
- Mainsheet, halyard, vang and spinnaker control lines on off-the-beach catamarans, one design classes and sportsboats up to 8m (26ft).

- Ball bearings: Acetal.
- BB sheaves: UV stabilised acetal (RF44000 & RF44108 Torlon® ball bearings).
- SP sheaves: Self-lubricating Nylatron®.

- Cheeks: Impact modified, fibre reinforced and UV stabilised nylon.
- Load straps & head fittings: Grade 316 stainless steel.

PRODUCT No.	DESCRIPTION	SHEAVE	MAX.	MAX.	PIN	M.W.L.	B.L.	WEIGHT	SHEAVE	MAX.	MAX.	PIN	M.W.L.	B.L.	WEIGHT
		DIAM.	ROPE	WIRE	DIAM.	kg	kg	g	DIAM.	ROPE	WIRE	DIAM.	lb	lb	oz
		mm	mm	mm	mm				in.	in.	in.	in.			
BB Ball Bearing															
RF40140	Stand-up block, swivel shackle head	40	10	-	-	350	800	71	1 9/16	3/8	-	-	770	1760	2.5
RF40171	Upright lead block	40	10	-	-	350	1000	60	1 9/16	3/8	-	-	770	2200	2.1
RF44000	Sheave, alloy, Torlon® balls	40	6	-	-	-	-	15	1 9/16	1/4	-	-	-	-	0.5
RF44108	Single block, removable loop head, alloy sheave, Torlon® balls	40	6	-	6	240	1100	60	1 9/16	1/4	-	7/32	530	2430	2.1
RF40500	Fiddle block, universal head	40+24	8	-	5	350	1000	90	1 9/16+15/16	5/16	-	3/16	770	2200	3.2
RF40510	Fiddle block, becket, universal head	40+24	8	-	5	350	1000	97	1 9/16+15/16	5/16	-	3/16	770	2200	3.4
RF40520	Fiddle block, adjustable cleat, universal head	40+24	8	-	5	350	1000	156	1 9/16+15/16	5/16	-	3/16	770	2200	5.5
RF40530	Fiddle block, becket, adjustable cleat, universal head	40+24	8	-	5	350*	1000	163	1 9/16+15/16	5/16	-	3/16	770*	2200	5.7
Accessories															
RF6170	Snap shackle head adapter	-	-	-	5	500	1000	49	-	-	-	3/16	1100	2200	1.7

* Line load through cleat not to exceed 125kg (275lb).

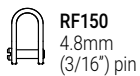

RF150
4.8mm
(3/16") pin

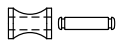

RF41010
Snap-in keyhole
becket pin



RF134
RF134A (countersunk holes)



RF321
Suits shackle
head blocks



RF2454
Suits loop
head blocks

- ✓ Self-lubricating acetal polymer sheave ensures low friction and extreme durability.
- ✓ High static and dynamic load capacity.
- ✓ Long service life, virtually maintenance free.

- ✓ Captive Lock™ universal head can be fixed at 0° or 90°, or left free to swivel on single blocks.
- ✓ Double & triple blocks have a swivel shackle head for full 360° rotation (non-locking).

- ✓ Removable becket pins allow lines to be spliced prior to fitting and are locked into position without the use of split rings or tools.
- ✓ Low profile stand-up block has swivel head post to allow full articulation and rotation.

PRODUCT No.	DESCRIPTION	SHEAVE	MAX.	PIN DIAM.	M.W.L.	B.L.	WEIGHT	SHEAVE	MAX.	PIN DIAM.	M.W.L.	B.L.	WEIGHT
		DIAM.	ROPE					DIAM.	ROPE				
		mm	mm	mm	kg	kg	g	in.	in.	in.	lb	lb	oz
AP All Purpose													
RF41100	Single block, universal head	40	10	5	400	1000	71	1 9/16	7/16	3/16	880	2200	2.5
RF41101	Single block, loop head	40	10	-	400	1000	54	1 9/16	7/16	-	880	2200	1.9
RF41110	Single block, becket, universal head	40	10	5	400	1000	80	1 9/16	7/16	3/16	880	2200	2.8
RF41111	Single block, becket, loop head	40	10	-	400	1000	61	1 9/16	7/16	-	880	2200	2.2
RF41140	Stand-up block, swivel head	40	10	-	400	800	72	1 9/16	7/16	-	880	1760	2.5
RF41200	Double block, swivel shackle head (non-locking)	40	10	5	600	1200	135	1 9/16	7/16	3/16	1320	2650	4.8
RF41210	Double block, becket, swivel shackle head (non-locking)	40	10	5	600	1200	143	1 9/16	7/16	3/16	1320	2650	5.0
RF41300	Triple block, swivel shackle head (non-locking)	40	10	5	700	1400	195	1 9/16	7/16	3/16	1540	3090	6.9
RF41310	Triple block, becket, swivel shackle head (non-locking)	40	10	5	700	1400	209	1 9/16	7/16	3/16	1540	3090	7.4



- ✓ Curved base adapter for cheek block facilitates mounting on masts or booms.
- ✓ Fiddle blocks are ideal for fine-tune mainsheet tackles, cunninghams, boom vang, backstays and other control line purchase systems.
- ✓ Captive Lock™ universal head can be fixed at 0° or 90°, or left free to swivel on single blocks.

- ✓ Quick adjusting cleat arms require no tools to adjust and fix in desired position.
- ✓ Snap shackle adapter suits single and fiddle blocks.
- ⬆ Mainsheet and halyard applications, vang and spinnaker control lines on off-the-beach boats and small keelboats up to 8m (26ft).

- ⚙ Sheaves: UV stabilised acetal.
- ⚙ Cheeks: Impact modified, fibre reinforced and UV stabilised nylon.
- ⚙ Load straps & head fittings: Grade 316 stainless steel.

PRODUCT No.	DESCRIPTION	SHEAVE DIAM.	MAX. ROPE	PIN	M.W.L.	B.L.	WEIGHT	SHEAVE	MAX. ROPE	PIN	M.W.L.	B.L.	WEIGHT
		mm	mm	DIAM. mm	kg	kg	g	DIAM. in.	in.	DIAM. in.	lb	lb	oz
AP All Purpose													
RF41151	Cheek block, stainless steel cheeks	40	10	-	400	1000	66	1 9/16	3/8	-	880	2200	2.3
RF41171	Upright lead block	40	10	4	400	1000	59	1 9/16	3/8	5/32	800	2200	2.1
RF41500	Fiddle block, universal head	40 + 24	8	5	400	1000	91	1 9/16 + 15/16	5/16	3/16	880	2200	3.2
RF41510	Fiddle block, becket, universal head	40 + 24	8	5	400	1000	98	1 9/16 + 15/16	5/16	3/16	880	2200	3.5
RF41520	Fiddle block, adjustable cleat, universal head	40 + 24	8	5	400*	1000	157	1 9/16 + 15/16	5/16	3/16	880*	2200	5.5
RF41530	Fiddle block, becket, adjustable cleat, universal head	40 + 24	8	5	400*	1000	164	1 9/16 + 15/16	5/16	3/16	880*	2200	5.8
RF41811	Cheek block, aluminium cheeks	40	12	-	400	1000	65	1 9/16	1/2	-	880	2200	2.3
Accessories													
RF6170	Snap shackle head adapter	-	-	5	500	1000	49	-	-	3/16	1100	2200	1.7
RF41153	Curved surface adapter for RF41151 cheek block	-	-	-	-	-	9	-	-	-	-	-	0.3

* Line load through cleat not to exceed 125kg (275lb).

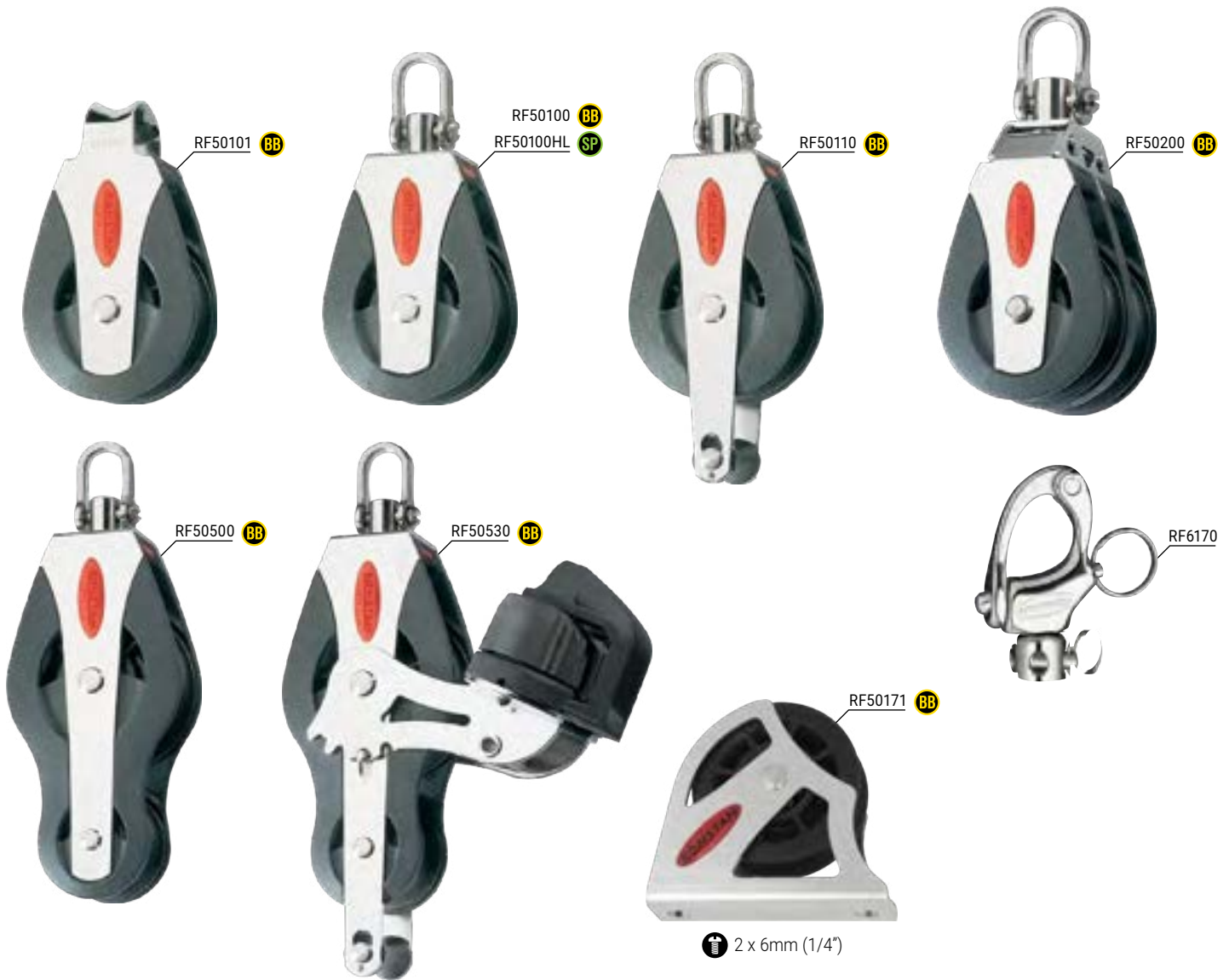

RF150
4.8mm (3/16") pin, suits single & fiddle blocks

RF151
6mm (1/4") pin, suits double block

RF1055
Suits shackle head blocks

RF321
Suits single & fiddle swivel shackle head blocks

RF51010
Snap-in keyhole becket pin

- 2-stage ball bearing system.
- High static and dynamic load capacity.
- Removable becket pins allow lines to be spliced prior to fitting and are locked into position without the use of split rings or tools.

- Cheek cut-outs for easy bearing maintenance.
- Snap shackle adapter adds functionality to single and fiddle blocks.
- Ball bearings: Acetal.
- BB sheaves: UV stabilised acetal.

- SP sheave: Self-lubricating Nylatron®.
- Cheeks: Impact modified, fibre reinforced and UV stabilised nylon.
- Load straps & head fittings: Grade 316 stainless steel.

PRODUCT No.	DESCRIPTION	SHEAVE	MAX.	MAX.	PIN	M.W.L.	B.L.	WEIGHT	SHEAVE	MAX.	MAX.	PIN	M.W.L.	B.L.	WEIGHT
		DIAM.	ROPE	WIRE	DIAM.				DIAM.	ROPE	WIRE	DIAM.			
		mm	mm	mm	mm	kg	kg	g	in.	in.	in.	in.	lb	lb	oz
BB Ball Bearing															
RF50100	Single block, universal head	50	12	-	5	500	1500	117	2	1/2	-	3/16	1100	3310	4.1
RF50101	Single block, loop head	50	12	-	-	500	1500	97	2	1/2	-	-	1100	3310	3.4
RF50110	Single block, becket, universal head	50	12	-	5	500	1500	133	2	1/2	-	3/16	1100	3310	4.7
RF50171	Upright lead block	50	12	-	-	500	1500	116	2	1/2	-	-	1100	3310	4.1
RF50200	Double block, swivel shackle head (non-locking)	50	12	-	6	800	2000	254	2	1/2	-	1/4	1760	4410	9.0
RF50500	Fiddle block, universal head	54 + 34	10	-	5	500	1500	166	2 1/8 + 1 5/16	3/8	-	3/16	1110	3310	5.9
RF50530	Fiddle block, becket, adjustable cleat, universal head	54 + 34	10	-	5	500*	1500	371	2 1/8 + 1 5/16	3/8	-	3/16	1110*	3310	11.2
SP Special Purpose - Nylatron® Sheave															
RF50100HL	Single block, universal head	50	12	5	5	750	1500	117	2	1/2	3/16	3/16	1650	3310	4.1
Accessories															
RF6170	Snap shackle head adapter	-	-	-	5	500	1000	49	-	-	-	3/16	1100	2200	1.7

* Line load through cleat not to exceed 175kg (385lb).





RF150
4.8mm (3/16") pin,
suits single and
fiddle blocks

RF151
6mm (1/4") pin,
suits S50 double and triple
blocks & S60 single block

RF1055
Suits shackle
head blocks

RF321
Suits swivel
shackle head
blocks

RF51010
Snap-in keyhole
becket pin

- ✔ Self-lubricating acetal polymer sheave ensures low friction and extreme durability.
- ✔ High static and dynamic load capacity.
- ✔ Long service life, virtually maintenance free.

- ✔ Captive Lock™ universal head can be fixed at 0° or 90°, or left free to swivel on S50 single and fiddle blocks.
- ✔ Double & triple blocks have a swivel shackle head for full 360° rotation (non-locking).

- ✔ Removable becket pins allow lines to be spliced prior to fitting and are locked into position without the use of split rings or tools.

PRODUCT No.	DESCRIPTION	SHEAVE DIAM. mm	MAX. ROPE mm	PIN DIAM. mm	M.W.L. kg	B.L. kg	WEIGHT g	SHEAVE DIAM. in.	MAX. ROPE in.	PIN DIAM. in.	M.W.L. lb	B.L. lb	WEIGHT oz
Series 50 - All Purpose													
RF51100	Single block, universal head	50	12	5	750	1500	118	2	1/2	3/16	1650	3310	4.2
RF51101	Single block, loop head	50	12	-	750	1500	98	2	1/2	-	1650	3310	3.5
RF51110	Single block, becket, universal head	50	12	5	750	1500	134	2	1/2	3/16	1650	3310	4.7
RF51111	Single block, becket, loop head	50	12	-	750	1500	114	2	1/2	-	1650	3310	4.0
RF51200	Double block, swivel shackle head (non-locking)	50	12	6	1000	2000	255	2	1/2	1/4	2200	4410	9.0
RF51210	Double block, becket, swivel shackle head (non-locking)	50	12	6	1000	2000	271	2	1/2	1/4	2200	4410	9.6
RF51300	Triple block, swivel shackle head (non-locking)	50	12	6	1200	2400	369	2	1/2	1/4	2650	5290	13.0
Series 60 - All Purpose													
RF66100	Single block, swivel shackle head (non-locking)	60	14	6	1100	2200	248	2 3/8	9/16	1/4	2430	4850	8.7



- ✔ Fiddle blocks are ideal for fine-tune mainsheet tackles, cunninghams, boom vang, backstays and other control line purchase systems.
- ✔ Snap shackle adapter adds functionality to single and fiddle blocks, and suit single and fiddle blocks.

- ✔ Quick adjusting cleat arms require no tools to adjust and fix in desired position.
- ✔ Low profile stand-up block has a swivel head post to allow full articulation and rotation.
- ⬆ Mainsheet and halyard applications, vang and spinnaker control lines on boats to 10m (33ft).

- ⚙ Sheaves: UV stabilised acetal.
- ⚙ Cheeks: Impact modified, fibre reinforced and UV stabilised nylon.
- ⚙ Load straps & head fittings: Grade 316 stainless steel bearing race.

PRODUCT No.	DESCRIPTION	SHEAVE DIAM.	MAX. ROPE	PIN DIAM.	M.W.L.	B.L.	WEIGHT	SHEAVE DIAM.	MAX. ROPE	PIN DIAM.	M.W.L.	B.L.	WEIGHT
		mm	mm	mm	kg	kg	g	in.	in.	in.	lb	lb	oz
AP RF51140	Stand-up block, swivel head	50	12	-	500	1000	118	2	1/2	-	1100	2200	4.2
RF51151	Cheek block, aluminium cheeks	50	12	-	500	1000	85	2	1/2	-	1100	2200	3.0
RF51171	Upright lead block	50	12	-	750	1500	115	2	1/2	-	1650	3310	4.1
RF51500	Fiddle block, universal head	54 + 34	10	5	750	1500	167	2 1/8 + 1 5/16	3/8	3/16	1650	3310	5.9
RF51510	Fiddle block, becket, universal head	54 + 34	10	5	750	1500	176	2 1/8 + 1 5/16	3/8	3/16	1650	3310	6.2
RF51530	Fiddle block, becket, adjustable cleat, universal head	54 + 34	10	5	750*	1500	318	2 1/8 + 1 5/16	3/8	3/16	1650*	3310	11.2
Accessories													
RF6170	Snap shackle head adapter	-	-	5	500	1000	49	-	-	3/16	1100	2200	1.7

* Line load through cleat not to exceed 175kg (385lb).

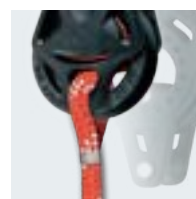
RF55110 **BB**RF55210 **BB**

Integrated becket



RF55410

RF45201
see page 18RF9004-09
see page 33RF56330B
see page 36**9:1 MAINSHEET SYSTEM**RF55310 **BB**RF55410 **BB**RF150
4.8mm (3/16") pin.

- ✔ 2-stage ball bearing system.
- ✔ Swivel shackle head for unlimited block rotation.
- ✔ Single inner cheeks on multi-sheave blocks for reduced weight and bulk.
- ✔ Ultra-low profile integrated becket.

- ⬆ Mainsheet systems on dinghies, catamarans, sportsboats and small keelboats to 9m (30ft).
- ⬆ RF55410 when paired with a RF56330B and a RF45201 lashed to the becket with a RF9004-09, produces a powerful 9:1 mainsheet system for use on catamarans to 5.5m (18ft). 8mm (5/16") rope recommended.

- ⬆ Halyard, vang and backstay applications on boats to 8m (26ft).
- ⬆ Control line applications on larger yachts.
- ⬆ Swivel shackle head fitting: Grade 316 stainless steel.

PRODUCT No.	DESCRIPTION	SHEAVE	MAX.	PIN DIAM.	M.W.L.	B.L.	WEIGHT	SHEAVE	MAX.	PIN DIAM.	M.W.L.	B.L.	WEIGHT
		DIAM.	ROPE					DIAM.	ROPE				
		mm	mm	mm	kg	kg	g	in.	in.	in.	lb	lb	oz
BB RF55110	Single block, becket, swivel shackle head	55	10	5	500 ^{*1}	1000	88	2 5/32	3/8	3/16	1100 ^{*1}	2200	3.1
RF55210	Double block, becket, swivel shackle head	55	10	5	750 ^{*2}	1500	172	2 5/32	3/8	3/16	1650 ^{*2}	3300	6.1
RF55310	Triple block, becket, swivel shackle head	55	10	5	750 ^{*2}	1500	244	2 5/32	3/8	3/16	1650 ^{*2}	3300	8.6
RF55410	Quad block, becket, swivel shackle head	55	10	5	750 ^{*2}	1500	316	2 5/32	3/8	3/16	1650 ^{*2}	3300	11.2

*1 Total block load. Load on becket not to exceed 50% of block load. i.e. MWL 250kg (550lb), BL 500kg (1100lb). Suitable for 2:1 system at rated block load.

*2 Total block load. Load on becket not to exceed 33% of block load. i.e. MWL 250kg (550lb), BL 500kg (1100lb).



2 x 6mm (1/4")



3 x 5mm (3/16")

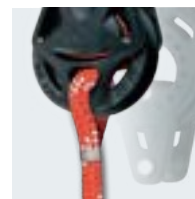

Integrated becket



Low profile head

- ✔ Single inner cheeks on doubles and triples for reduced weight and bulk.
- ✔ RF55111 - Ultra-low profile integrated becket.
- ✔ RF55151 - Recessed underside suits flat or curved mounting surface.

- ⬆ Mainsheet systems and spinnaker sheets on dinghies, sportsboats and small keelboats to 9m (30ft).
- ⬆ Halyard, vang and backstay applications on boats to 8m (26ft).

- ⬆ Control line applications on larger yachts.

PRODUCT No.	DESCRIPTION	SHEAVE DIAM.	MAX. ROPE	PIN DIAM.	M.W.L.	B.L.	WEIGHT	SHEAVE DIAM.	MAX. ROPE	PIN DIAM.	M.W.L.	B.L.	WEIGHT
		mm	mm	mm	kg	kg	g	in.	in.	in.	lb	lb	oz
BB Ball Bearing													
RF55101	Single block, Dyneema® link head	55	10	-	500	1000	68	2 5/32	3/8	-	1100	2200	2.4
RF55111	Single block, becket, Dyneema® link head	55	10	-	500	1000	75	2 5/32	3/8	-	1100	2200	2.6
RF55151	Cheek block	55	10	-	500	1000	70	2 5/32	3/8	-	1100	2200	2.5
RF55171	Upright lead block	55	10	-	500	1000	91	2 5/32	3/8	-	1100	2200	3.2
RF55201	Double block, Dyneema® link head	55	10	-	800	1600	134	2 5/32	3/8	-	1765	3520	4.7
RF55301	Triple block, Dyneema® link head	55	10	-	1000	2000	205	2 5/32	3/8	-	2200	4410	7.2

* Total block load. Load on becket not to exceed 50% of block load. i.e. MWL 250kg (550lb), BL 500kg (1100lb). Suitable for 2:1 system at rated block load.



✓ RF55511 & RF55531 - Lightweight integrated Dyneema® becket link.

✓ RF55521, RF55531 - Composite C-Cleat™ and fairlead.

⚙️ Sheave: Carbon fibre reinforced, PTFE impregnated nylon.

⚙️ Ball bearings: High compression strength acetal.

⚙️ Stage 2 bearing: Carbon fibre reinforced, PTFE impregnated nylon.

⚙️ Frame/cheeks: Toughened, glass fibre reinforced nylon.

⚙️ Rope link: UV stabilised, multi-strand SK78 Dyneema®.

PRODUCT No.	DESCRIPTION	SHEAVE	MAX.	PIN	M.W.L.	B.L.	WEIGHT	SHEAVE	MAX.	PIN	M.W.L.	B.L.	WEIGHT
		DIAM.	ROPE	DIAM.	kg	kg	g	DIAM.	ROPE	DIAM.	lb	lb	oz
		mm	mm	mm				in.	in.	in.			
BB RF55501	Fiddle block* ¹ , Dyneema® link head	55 + 35	10	-	500	1000	95	2 5/32 + 1 3/8	3/8	-	1100	2200	3.4
RF55511	Fiddle block* ¹ , becket, Dyneema® link head	55 + 35	10	-	500	1000	97	2 5/32 + 1 3/8	3/8	-	1000	2200	3.4
RF55521	Fiddle block* ¹ , adjustable cleat, Dyneema® link head	55 + 35	10	-	500 ²	1000	232	2 5/32 + 1 3/8	3/8	-	1100 ²	2200	8.1
RF55531	Fiddle block* ¹ , becket, adjustable cleat, Dyneema® link head	55 + 35	10	-	500 ²	1000	233	2 5/32 + 1 3/8	3/8	-	1100 ²	2200	8.2

*1 Small fiddle block sheave has a high load full contact bearing (i.e. not ball bearing). Main sheave has 2-stage, ball bearing.

*2 Line load through cleat not to exceed 175kg (385lb).

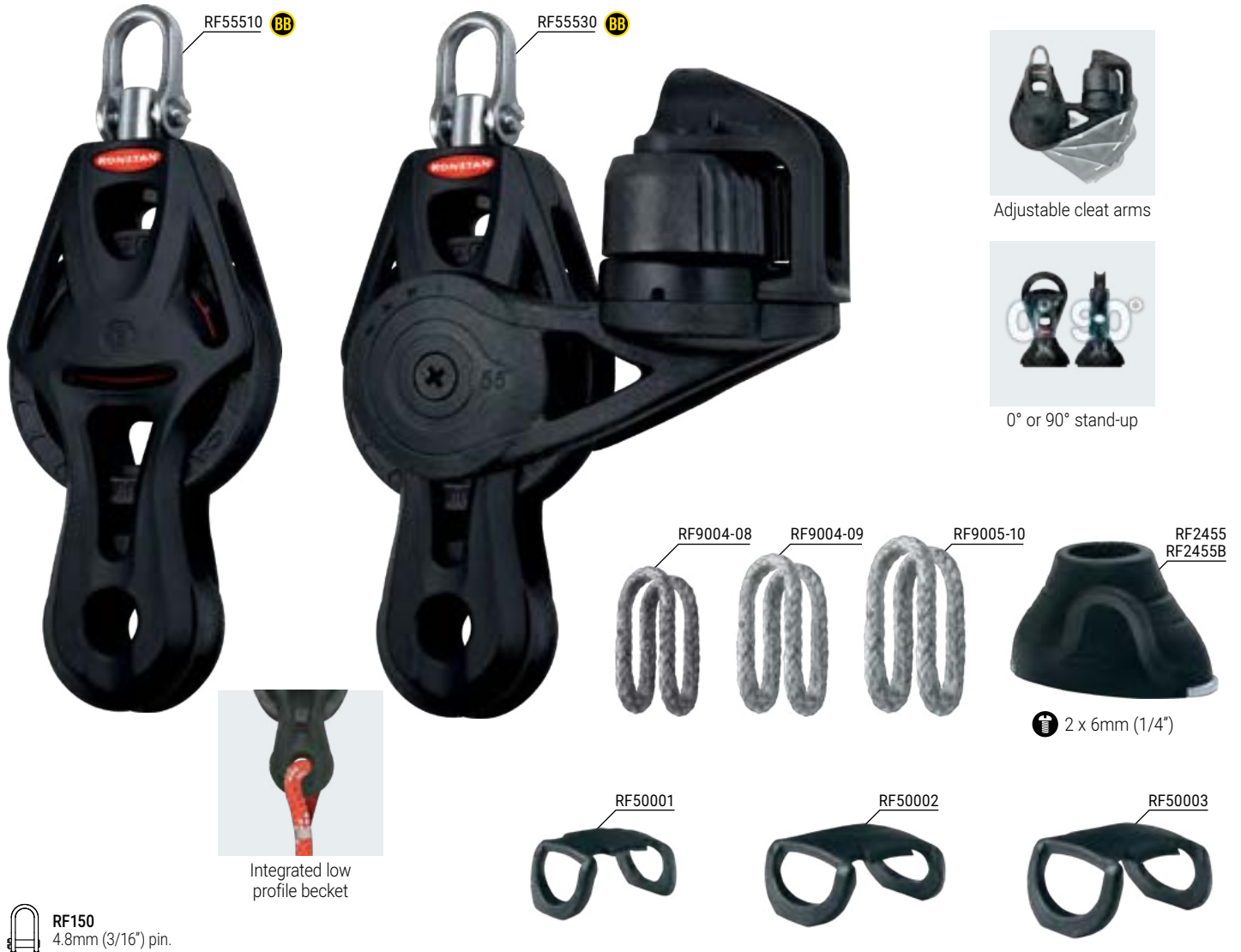

RF150
4.8mm (3/16") pin.

Integrated low profile becket

- ✔ RF55530 - Composite C-Cleat™ and fairlead.
- ✔ Ultra-low profile integrated hollow hub becket.
- ✔ Swivel shackle head for unlimited block rotation.
- ⬆ Mainsheet and vang systems on dinghies, sportsboats and small keelboats to 9m (30ft).
- ⬆ Control line applications on larger yachts.

- ⚙ Sheave: Carbon fibre reinforced, PTFE impregnated nylon.
- ⚙ Ball bearings: High compression strength acetal.
- ⚙ Stage 2 bearing: Carbon fibre reinforced, PTFE impregnated nylon.

- ⚙ Frame/cheeks: Toughened, glass fibre reinforced nylon.
- ⚙ Swivel shackle head fitting: Grade 316 stainless steel.
- ⚙ Rope link: UV stabilised, multi-strand SK78 Dyneema®.

PRODUCT No.	DESCRIPTION	SHEAVE	MAX.	PIN	M.W.L.	B.L.	WEIGHT	SHEAVE	MAX.	PIN	M.W.L.	B.L.	WEIGHT
		DIAM.	ROPE	DIAM.	kg	kg	g	DIAM.	ROPE	DIAM.	lb	lb	oz
		mm	mm	mm				in.	in.	in.			
BB Ball Bearing													
RF55510	Fiddle block ^{*1} , becket, swivel shackle head	55 + 35	10	5	500 ^{*2}	1000	101	2 5/32 + 1 3/8	3/8	3/16	1100 ^{*2}	2200	3.6
RF55530	Fiddle block ^{*1} , becket, adjustable cleat, swivel shackle head	55 + 35	10	5	500 ^{*2}	1000	237	2 5/32 + 1 3/8	3/8	3/16	1100 ^{*2}	2200	8.4
Accessories													
RF2455	Stand-up base, suits S55 Orbit Blocks™ - boot & saddle	-	-	-	500	1000	26	-	-	-	1100	2200	0.9
RF2455B	Stand-up boot, suits S55 Orbit Blocks™ - boot only	-	-	-	-	-	11	-	-	-	-	-	0.4
Dyneema® Links		Blocks Suited											
RF9004-08	Link to suit S55 single & fiddle Orbit Blocks™	RF55101, RF55111, RF55501, RF55511, RF55521, RF55531, RF56101											
RF9004-09	Link to suit S55 9:1 mainsheet system (see page 30)	Connecting RF45201 to RF56330B											
RF9005-10	Link to suit S55 double & triple Orbit Blocks™	RF55201, RF55301											
Link Retainers Clips (2 pack)		Blocks Suited											
RF50001	Clip to suit S55 single & fiddle Orbit Blocks™	RF55101, RF55111, RF55501, RF55511, RF55521, RF55531, RF56101											
RF50002	Clip to suit S55 double & triple Orbit Blocks™	RF55201											
RF50003	Clip to suit S55 triple Orbit Blocks™	RF55301											

*1 Small fiddle block sheave has a high load full contact bearing (i.e. not ball bearing). Main sheave has 2-stage, ball bearing.
*2 Line load through cleat not to exceed 175kg (385lb).

ORBIT BLOCK™ RATCHET HOLDING POWER 20:1

RF56101 **BB**RF56100 **BB**RF56110 **BB**

Auto & manual ratchet modes



Load sensing auto ratchet

RF150
4.8mm (3/16") pin

- ✓ RF56100 & RF56110 - swivel shackle head for unlimited block rotation.
- ⬆️ Dinghy mainsheet systems.
- ⬆️ Mainsheet systems on sportsboats using RF6 or RF7 mainsheet swivel cleat unit.
- ⬆️ Spinnaker sheets on dinghies.

- ⬆️ Spinnaker sheets on sportsboats and small keelboats (lateral lead blocks).
- ⬆️ Control line applications on larger yachts.
- ⬆️ Sheave: Anodised aluminium.
- ⬆️ Swivel shackle head fitting: Grade 316 stainless steel.

- ⬆️ Ball bearings: High compression strength acetal.
- ⬆️ Frame/cheeks: Toughened, glass fibre reinforced nylon.
- ⬆️ Rope link: UV stabilised, multi-strand SK78 Dyneema®.

PRODUCT No.	DESCRIPTION	SHEAVE	MAX.	PIN	M.W.L.	B.L.	WEIGHT	SHEAVE	MAX.	PIN	M.W.L.	B.L.	WEIGHT
		DIAM.	ROPE	DIAM.				DIAM.	DIAM.	DIAM.			
		mm	mm	mm	kg	kg	g	in.	in.	in.	lb	lb	oz
BB RF56100	Single block, auto and manual, swivel shackle head	55	10	5	250	750	82	2 5/32	3/8	3/16	550	1650	2.9
RF56101	Single block, auto and manual, Dyneema® link head	55	10	-	250	750	78	2 5/32	3/8	-	550	1650	2.8
RF56110	Single block, becket, auto and manual, swivel shackle head	55	10	5	250*	750	86	2 5/32	3/8	3/16	550*	1650	3.0

* Total block load. Load on becket not to exceed block load. i.e. MWL 250kg (550lb), BL 750kg (1650lb). Suitable for 2:1 system at rated block load.



© Ana Lukanc / Seascope



Adjustable cleat arms



Load sensing auto ratchet

RF150
 4.8mm (3/16") pin

- ✓ Swivel shackle head for unlimited block rotation.
- ✓ RF56120 & RF56130 - Composite C-Cleat™ and fairlead.
- ⬆ Dinghy mainsheet systems.
- ⬆ Spinnaker sheets on dinghies – especially modern asymmetric classes.
- ⬆ Spinnaker sheets on sportsboats and small keelboats (lateral lead blocks).
- ⬆ Control line applications on larger yachts.
- ⚙ Sheave: Anodised aluminium.
- ⚙ Ball bearings: High compression strength acetal.
- ⚙ Frame/cheeks: Toughened, glass fibre reinforced nylon.

PRODUCT No.	DESCRIPTION	SHEAVE	MAX.	PIN	M.W.L.	B.L.	WEIGHT	SHEAVE	MAX.	PIN	M.W.L.	B.L.	WEIGHT
		DIAM.	ROPE	DIAM.	kg	kg	g	DIAM.	ROPE	DIAM.	lb	lb	oz
		mm	mm	mm				in.	in.	in.			
BB RF56120	Single block, adjustable cleat, auto, swivel shackle head	55	10	5	250*2	750	204	2 5/32	3/8	3/16	550*2	1650	7.2
RF56130	Single block, becket, adjustable cleat, auto, swivel shackle head	55	10	5	250*1&2	750	209	2 5/32	3/8	3/16	550*1&2	1650	7.4

*1 Total block load. Load on becket not to exceed block load. i.e. MWL 250kg (550lb), BL 750kg (1650lb). Suitable for 2:1 system at rated block load.
 *2 Line load through cleat not to exceed 175kg (385lb).



RF150
4.8mm (3/16") pin

- ✓ RF56330B - Underhung becket is suitable for terminating the sheet, or attachment of a 'piggyback' block for greater purchase*2.
- ✓ Ultra-low profile integrated hollow hub becket on fiddle blocks.

- ✓ Swivel shackle head for unlimited block rotation.
- ✓ RF56330B when paired with a RF55410 and a RF45201 lashed to the becket with a RF9004-09, produces a powerful 9:1 mainsheet system for use on catamarans to 5.5m (18ft). 8mm (5/16) rope recommended.

- ⚙ Swivel shackle head fitting: Grade 316 stainless steel.

PRODUCT No.	DESCRIPTION	SHEAVE	MAX.	PIN	M.W.L.	B.L.	WEIGHT	SHEAVE	MAX.	PIN	M.W.L.	B.L.	WEIGHT
		DIAM.	ROPE	DIAM.				DIAM.	DIAM.	ROPE			
RF56151	Cheek block, clockwise, auto and manual, swivel shackle head	55	10	-	250	700	76	2 5/32	3/8	-	550	1540	2.7
RF56151A	Cheek block, anti-clockwise, auto and manual, swivel shackle head	55	10	-	250	700	76	2 5/32	3/8	-	550	1540	2.7
RF56330B	Triple block, underhung becket, adjustable cleat, auto, swivel shackle head	55	10	5	750 ^{*2&3}	1500	392	2 5/32	3/8	3/16	1650 ^{*2&3}	3300	13.8
RF56510	Fiddle block ^{*1} , becket, auto and manual, swivel shackle head	55 + 35	10	5	250	750	112	2 5/32 + 1 3/8	3/8	3/16	550	1650	3.9
RF56530	Fiddle block ^{*1} , becket, adjustable cleat, auto, swivel shackle head	55 + 35	10	5	250 ^{*3}	750	235	2 5/32 + 1 3/8	3/8	3/16	550 ^{*3}	1650	8.3

BB Ball Bearing

*1 Fiddle sheave has a high load full contact bearing (i.e. not ball bearing). Main sheave has 2-stage, ball bearing.
 *2 Total block load. Load on underhung becket not to exceed 33% of block load. i.e. MWL 250kg (700lb), BL 500kg (1100lb). Underhung becket suits attachment of 'piggyback' block for creation of 7:1 or greater purchase.
 *3 Line load through cleat not to exceed 175kg (385lb).

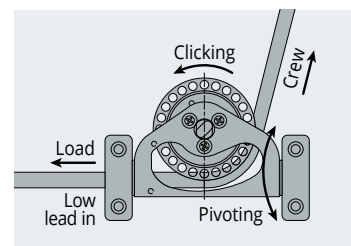
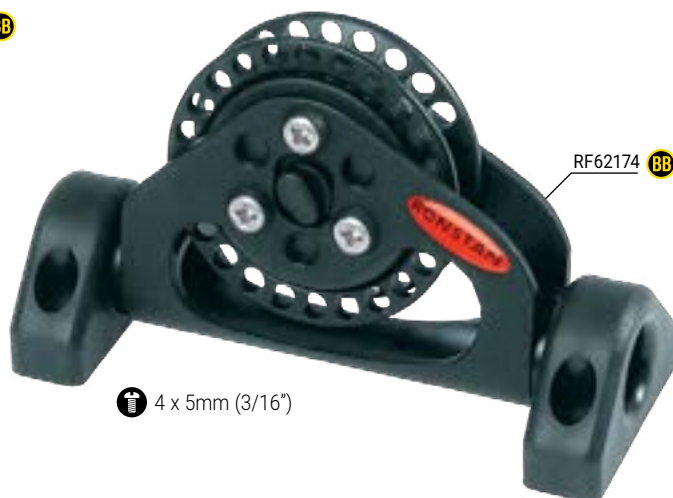
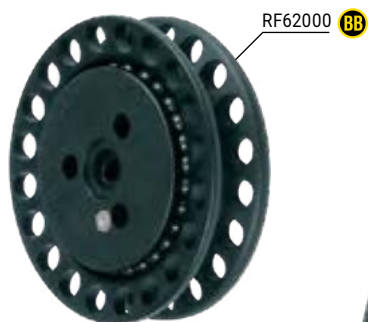

- ✔ Effective extruded hole design provides up to 20:1 holding power.
- ✔ On/Off switch is fitted to both sides of block so it can be used on port or starboard side. Switch can be removed from one side if required.
- ✔ Unique On/Off switch mechanism can be operated under load.
- ✔ Low friction ball bearing system.
- ✔ Pivoting Lead blocks maintain alignment and keep lines close to the deck.

- ⚙️ Dinghy mainsheet systems - when maximum holding power is required.
- ⚙️ RF62100 mainsheet systems on sportsboats using RF7 mainsheet swivel cleat unit.
- ⚙️ Control line applications on larger yachts.
- ⚙️ Spinnaker sheets on sportsboats and small keelboats (lateral lead blocks).

- ⚙️ Sheave & cheek plates: Anodised aluminium.
- ⚙️ Ball bearings: High compression strength acetal.
- ⚙️ Ratchet pawl: High strength Torlon®.
- ⚙️ Swivel shackle head fitting: Grade 316 stainless steel.

PRODUCT No.	DESCRIPTION	SHEAVE DIAM.	MAX. ROPE	PIN DIAM.	M.W.L.	B.L.	WEIGHT	SHEAVE DIAM.	MAX. ROPE	PIN DIAM.	M.W.L.	B.L.	WEIGHT
		mm	mm	mm	kg	kg	g	in.	in.	in.	lb	lb	oz
BB RF62000	Sheave	60	10	-	-	-	44	2 3/8	3/8	-	-	-	1.6
RF62100	Single block, manual, swivel shackle head	60	10	5	250	1370	135	2 3/8	3/8	3/16	550	3020	5.3
RF62174	Pivoting low lead block	60	10	-	250	1370	147	2 3/8	3/8	-	550	3020	5.2
RF62175	Pivoting low lead block, cleat	60	10	-	250	1370	285	2 3/8	3/8	-	550	3020	10.1



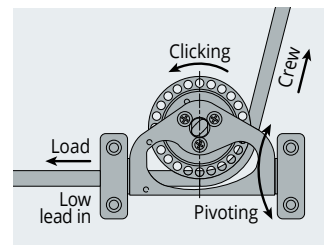

- ✔ Effective extruded hole design provides up to 20:1 holding power.
- ✔ On/Off switch is fitted to both sides of block so it can be used on port or starboard side. Switch can be removed from one side if required.
- ✔ Unique On/Off switch mechanism can be operated under load.
- ✔ Low friction ball bearing system.

- ✔ High quality forged stainless steel shackle and durable alloy cheek plates.
- ⬆ Dinghy mainsheet systems - when maximum holding power is required.
- ⬆ Control line applications on larger yachts.
- ⬆ Spinnaker sheets on sportsboats and small keelboats (lateral lead blocks).

- ⚙ Sheave & cheek plates: Anodised aluminium.
- ⚙ Ball bearings: High compression strength acetal.
- ⚙ Ratchet pawl: High strength Torlon®.
- ⚙ Swivel shackle head fitting: Grade 316 stainless steel.

PRODUCT No.	DESCRIPTION	SHEAVE DIAM.	MAX. ROPE	PIN DIAM.	M.W.L.	B.L.	WEIGHT	SHEAVE DIAM.	MAX. ROPE	PIN DIAM.	M.W.L.	B.L.	WEIGHT
		mm	mm	mm	kg	kg	g	in.	in.	in.	lb	lb	oz
BB RF72000	Sheave	75	12	-	-	-	90	3	1/2	-	-	-	3.2
RF72100	Single block, manual, swivel shackle head	75	12	7	420	2000	290	3	1/2	9/32	930	4410	5.7
RF72174	Pivoting low lead block	75	12	-	420	1370	270	3	1/2	-	930	3020	9.5
RF72175	Pivoting low lead block, cleat	75	12	-	420	1370	405	3	1/2	-	930	3020	14.3

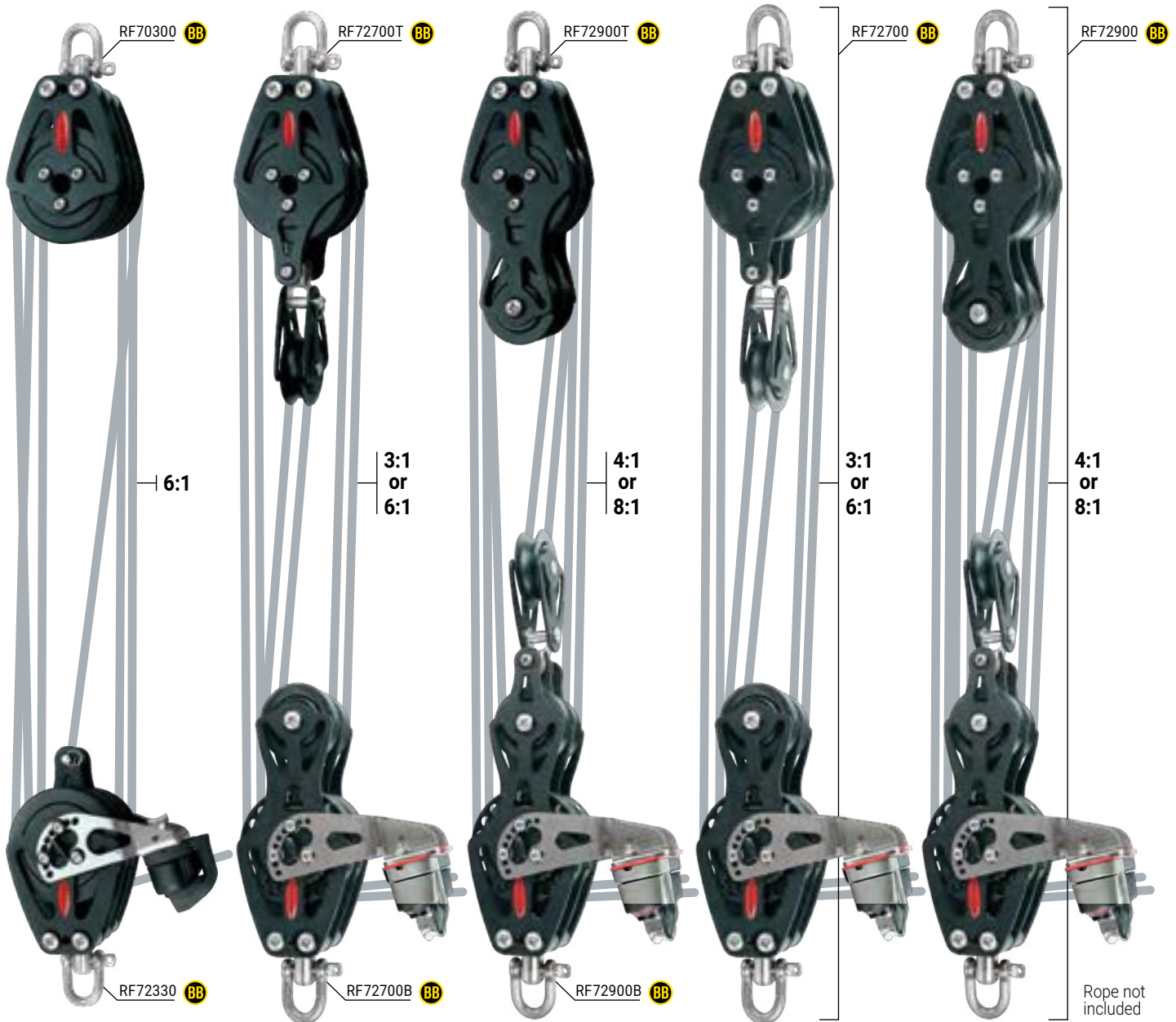

- Two-speed mainsheet systems allow fine tuning of the mainsheet when sailing upwind by using one of the sheet tails and keeping the other cleated. Using both the sheets at once allows the trimmer to blow off the main quickly when rounding the top mark and trim on quickly when hardening up after rounding the bottom mark.
- When fitting to traveller cars, ensure adequate support for the bottom block and use stand-up spring kit RF324-1 or RF324-2. (Refer to traveller section pages 100 & 105 for more information).

- Two-speed systems: Mainsheets on sportsboats and keelboats to 12m (40ft).
- MAXIMUM MAINSAIL AREA**
RF72700: End boom = 38m² (409ft²), Mid-boom = 23m² (248ft²)
RF72900: End boom = 42m² (452ft²), Mid-boom = 27m² (290ft²)

- Ball bearings: acetal.
- Sheaves: UV stabilised acetal (BB), alloy (ratchet).
- Cheeks & ratchet sheaves: Anodised aluminium.
- Ratchet pawl: Torton®.

PRODUCT No.	DESCRIPTION	SHEAVE DIAM.	MAX. ROPE	PIN DIAM.	M.W.L.	B.L.	WEIGHT	SHEAVE DIAM.	MAX. ROPE	PIN DIAM.	M.W.L.	B.L.	WEIGHT
		mm	mm	mm	kg	kg	g	in.	in.	in.	lb	lb	oz
RF70300	BB triple block, universal head	75	10	7	1250	2500	632	3	3/8	9/32	2760	5510	22.3
RF72330	Ratchet triple block, becket, cleat, universal head	75	10	7	685	2000	790	3	3/8	9/32	1510	4410	27.9
RF72700	Complete system, BB & ratchet 3:1 coarse, 6:1 fine	75 + 50	10	7	800	1700	1490	3 + 2	3/8	9/32	1760	3750	52.5
RF72700B	Ratchet bottom block for RF72700 two-speed system	75 + 50	10	7	800	1700	950	3 + 2	3/8	9/32	1760	3750	33.5
RF72700T	BB top blocks for RF72700 two-speed system	75 + 50	10	7	800	1700	560	3 + 2	3/8	9/32	1760	3750	19.8
RF72900	Complete system, BB & ratchet 4:1 coarse, 8:1 fine	75 + 50	10	7	1100	2300	1610	3 + 2	3/8	9/32	2430	5070	56.8
RF72900B	Ratchet bottom block for RF72900 two-speed system	75 + 50	10	7	1100	2300	1035	3 + 2	3/8	9/32	2430	5070	36.5
RF72900T	BB top block for RF72900 two-speed system	75 + 50	10	7	1100	2300	575	3 + 2	3/8	9/32	2430	5070	20.3

BB Ball Bearing

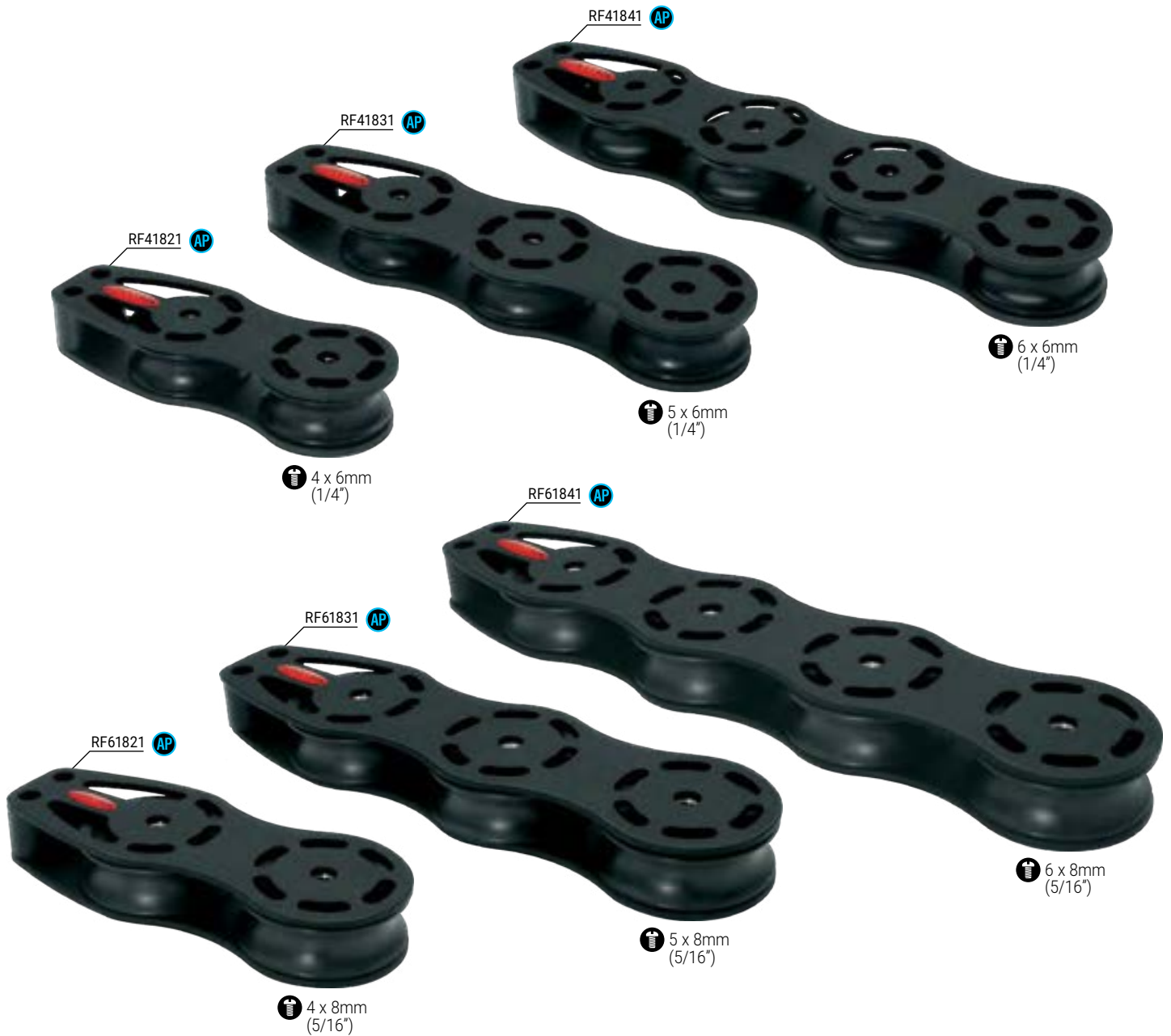

- ✔ Deck organisers are an effective means of deflecting halyards and control lines to winches, stoppers and cleats.
- ✔ All Purpose bearing system provides maximum static load capacity.
- ✔ Lightweight design with cheek cut-outs for easy bearing maintenance.
- ✔ All sizes can be stacked to create double versions - MWL of the top sheaves must not exceed 50% of the total block load rating.
- ⚠ Series 40 - halyard and control line deflection on boats to 11m (36ft).
- ⚠ Series 60 - halyard and control line deflection on boats to 14m (46ft).
- ⚠ Line deflection on larger yachts (depending on load and angle of deflection).
- ⚙ Cheek plates: Anodised aluminium.
- ⚙ Sheaves: UV stabilised acetal.
- ⚙ Hubs: Grade 316 stainless steel.

PRODUCT No.	DESCRIPTION	SHEAVE DIAM.	MAX. ROPE	LENGTH	HOLE SPACING	M.W.L.	B.L.	WEIGHT	SHEAVE DIAM.	MAX. ROPE	LENGTH	HOLE SPACING	M.W.L.	B.L.	WEIGHT
		mm	mm			(per sheave)	(per sheave)		in	in			in	in	
Series 40 - AP All Purpose															
RF41821	Double sheave organiser	40	12	116	48.5	500	1000	101	1 5/8	1/2	4 9/16	1 29/32	1100	2200	3.6
RF41831	Triple sheave organiser	40	12	164	48.5	500	1000	142	1 5/8	1/2	6 15/32	1 29/32	1100	2200	5.0
RF41841	Quadruple sheave organiser	40	12	213	48.5	500	1000	185	1 5/8	1/2	8 13/32	1 29/32	1100	2200	6.5
Series 60 - AP All Purpose															
RF61821	Double sheave organiser	60	14	164	70.0	1000	2000	271	2 3/8	9/16	6 15/32	2 3/4	2200	4410	9.6
RF61831	Triple sheave organiser	60	14	234	70.0	1000	2000	392	2 3/8	9/16	9 7/32	2 3/4	2200	4410	13.8
RF61841	Quadruple sheave organiser	60	14	304	70.0	1000	2000	511	2 3/8	9/16	11 31/32	2 3/4	2200	4410	18.0

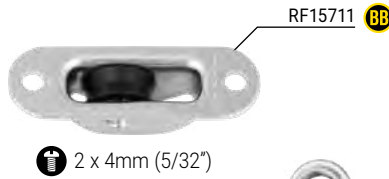
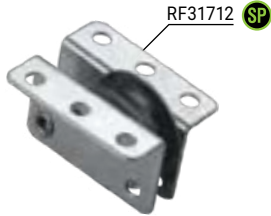
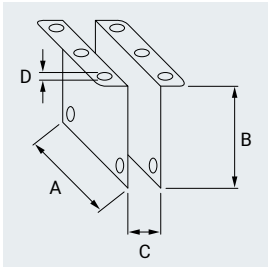

- Wire blocks have purpose designed narrow sheaves and grooves.
- Wire blocks suit halyards, vang and backstay applications.

- Exit and sheave boxes are ideal for applications where lines (rope or wire) need to be led through decks, bulkheads or spars minimising friction and chafing.

- BB sheaves: UV stabilised acetal.
- SP sheaves: Self-lubricating Nylatron®.
- Cheeks & housings: Grade 316 stainless steel.

PRODUCT No.	SHEAVE DIAM. mm	MAX. ROPE mm	MAX. WIRE mm	A mm	B mm	C mm	D mm	M.W.L. kg	B.L. kg	WEIGHT g	SHEAVE DIAM. in	MAX. ROPE in	MAX. WIRE in	A in	B in	C in	D in	M.W.L. lb	B.L. lb	WEIGHT oz
Sheave Boxes - SP Special Purpose, Nylatron® Sheave																				
RF31712	30	8	4	44.0	27	14.0	5	375	800	45	1 3/16	5/16	5/32	1 3/4	1 1/16	9/16	3/16	830	1760	1.6
RF41712	40	10	5	54.0	33	17.0	5	500	1000	75	1 9/16	3/8	3/16	2 1/8	1 5/16	1 1/16	3/16	1100	2200	2.6
RF51712	50	12	5	62.0	42	21.0	5	750	1500	145	2	1/2	3/16	2 7/16	1 5/8	1 3/16	3/16	1650	3300	5.1

PRODUCT No.	DESCRIPTION	SHEAVE DIAM. mm	MAX. ROPE mm	MAX. WIRE mm	M.W.L. kg	B.L. kg	WEIGHT g	SHEAVE DIAM. in	MAX. ROPE in	MAX. WIRE in	M.W.L. lb	B.L. lb	WEIGHT oz
Exit Blocks - BB Ball Bearing													
RF20711	Single exit block, cover plate	20	6	-	250	1000	22	3/4	1/4	-	550	2200	0.8
RF20711A	Single exit block, side tabs	20	6	-	250	1000	22	3/4	1/4	-	550	2200	0.8
RF30711	Single exit block, cover plate	30	8	-	300	750	35	1 3/16	5/16	-	660	1650	1.2
RF30721	Double exit block, cover plate	30	8	-	300	750	60	1 3/16	5/16	-	660	1650	2.1
RF15711	Exit block	15	5	-	120	550	14	5/8	3/16	-	260	1210	0.5

PRODUCT No.	DESCRIPTION	SHEAVE DIAM. mm	MAX. ROPE mm	MAX. WIRE mm	M.W.L. kg	B.L. kg	WEIGHT g	SHEAVE DIAM. in	MAX. ROPE in	MAX. WIRE in	M.W.L. lb	B.L. lb	WEIGHT oz
Exit Blocks - SP Special Purpose, Nylatron® Sheave													
RF20711HL	Single exit block, cover plate	20	6	3	275	1000	22	3/4	1/4	1/8	610	2200	0.8
RF20711AHL	Single exit block, side tabs	20	6	3	275	1000	22	3/4	1/4	1/8	610	2200	0.8
RF30711HL	Single exit block, cover plate	30	8	3	300	750	43	1 3/16	5/16	1/8	660	1650	1.5

PRODUCT No.	DESCRIPTION	SHEAVE DIAM. mm	MAX. ROPE mm	MAX. WIRE mm	M.W.L. kg	B.L. kg	WEIGHT g	SHEAVE DIAM. in	MAX. ROPE in	MAX. WIRE in	M.W.L. lb	B.L. lb	WEIGHT oz
Wire Blocks - SP Special Purpose, Nylatron® Sheave													
RF103	Single block, tubular rivet head, removable sheave	45	6	6	850	1700	88	1 3/4	1/4	1/4	1870	3740	3.1
RF104	Single block, ferrule top, removable sheave	45	6	6	850	1700	80	1 3/4	1/4	1/4	1870	3740	2.8
RF418	Single block, tubular rivet head	25	3	3	450	900	40	1	1/8	1/8	990	1980	1.4
RF418C	Single block, removable clevis pin head	25	3	3	450	900	39	1	1/8	1/8	990	1980	1.4
RF468	Single block, ferrule top, removable sheave	25	3	3	450	900	33	1	1/8	1/8	990	1980	1.2
RF560	Single block, ferrule eye	20	3	3	250	500	20	3/4	1/8	1/8	550	1100	0.7
RF667	Single block, loop top	20	2	2	200	400	20	3/4	3/32	3/32	440	880	0.7

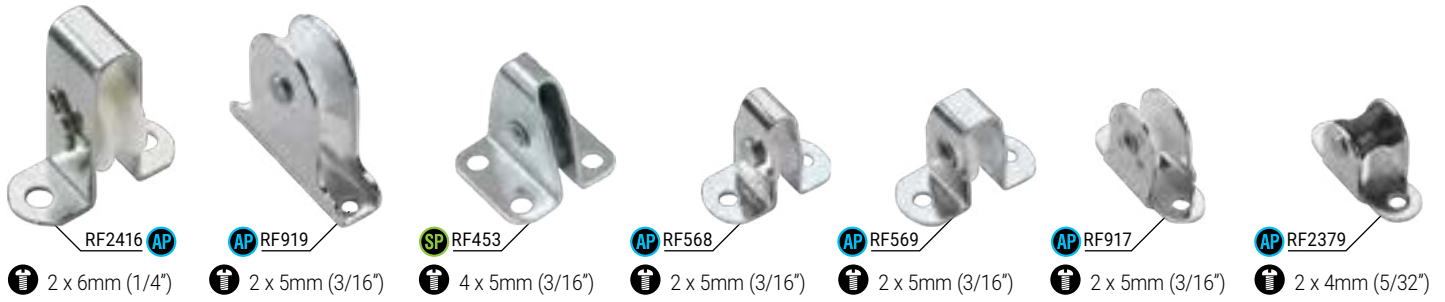

- Upright lead blocks are a low profile solution for leading lines to cleats or jammers.
- BB & AP sheaves: UV stabilised acetal.
- SP sheave: Self-lubricating Nylatron®.
- Cheeks: Grade 316 stainless steel.

PRODUCT No.	DESCRIPTION	SHEAVE DIAM. mm	MAX. ROPE mm	MAX. WIRE mm	M.W.L. kg	B.L. kg	WEIGHT g	SHEAVE DIAM. in	MAX. ROPE in	MAX. WIRE in	M.W.L. lb	B.L. lb	WEIGHT oz
BB Ball Bearing													
RF15171	Upright lead block	15	5	-	120	550	9	5/8	3/16	-	260	1210	0.3
RF15174	Pivoting lead block	15	5	-	120	350	16	5/8	3/16	-	260	770	0.6
RF20171	Upright lead block	20	6	-	250	550	18	3/4	1/4	-	550	1210	0.6
RF20174	Pivoting lead block	20	6	-	250	550	30	3/4	1/4	-	550	1210	1.1
RF30171	Upright lead block	30	8	-	300	750	30	1 3/16	5/16	-	660	1650	1.1
RF30174	Pivoting lead block	30	8	-	300	650	50	1 3/16	5/16	-	660	1320	1.8
RF40171	Upright lead block	40	10	-	350	1000	60	1 9/16	3/8	-	770	2200	2.1
RF50171	Upright lead block	50	12	-	500	1500	116	2	1/2	-	1100	3310	4.1
RF55171	Upright lead block	55	10	-	500	1000	91	2 5/32	3/8	-	1100	2200	3.2
SP Special Purpose - Nylatron® sheave													
RF453	Upright lead block	22	3	3	160	320	30	7/8	1/8	1/8	350	700	1.1
AP All Purpose													
RF568	Upright lead block, removable sheave	19	5	-	250	500	20	3/4	3/16	-	550	1100	0.7
RF569	Upright lead block	19	8	-	250	500	20	3/4	5/16	-	550	1100	0.7
RF917	Upright lead block	19	8	-	250	500	20	3/4	5/16	-	550	1100	0.7
RF919	Upright lead block	29	6	-	600	1200	50	1 3/32	1/4	-	1320	2640	1.8
RF2379	Upright lead block	13	5	-	250	500	20	19/32	3/16	-	550	1100	0.7
RF2416	Upright lead block, removable sheave	32	5	-	300	800	40	1 1/4	3/16	-	660	1760	1.4
RF41171	Upright lead block	40	10	-	400	1000	59	1 9/16	3/8	-	880	2200	2.1
RF51171	Upright lead block	50	12	-	750	1500	115	2	1/2	-	1650	3310	4.1





RF8080BLU



RF8080GRY



RF8080R



RF8081BLU



RF8081R

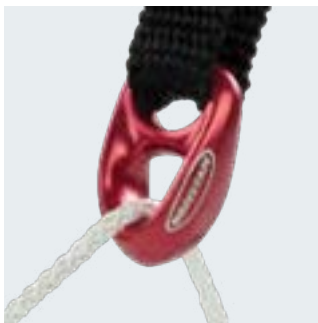

Webbing

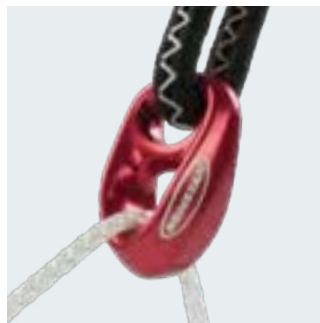

Pigtail

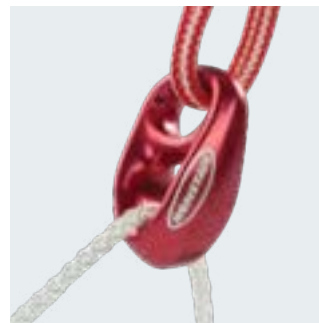

Lashing

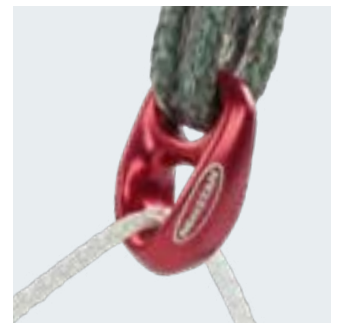

Dyneema® Link

ATTACHMENT OPTIONS

- ✔ Ultra-lightweight.
- ✔ Ultra-compact.
- ✔ Durable.
- ✔ Colour coded.
- ✔ High load capacity.
- ✔ Suits webbing or lashing.
- ✔ Versatile.
- ✔ Vangs.
- ✔ Tweakers.
- ✔ Barberhaulers.
- ✔ Sail cover zipper lines.
- ✔ Lazy jacks.
- ✔ Cunninghams.
- ✔ Kite bridles.
- ✔ Leech lines.
- ✔ Trapeze elastics.
- ✔ Various control lines.
- ✔ Anodised aluminium.

 For further technical details see the SUPPORT tab at www.ronstan.com.

PRODUCT No.	COLOUR	ROPE SIZE mm	LENGTH mm	WIDTH mm	THICKNESS mm	MAX. ATTACHMENT mm	B.L. kg	WEIGHT g	ROPE SIZE in.	LENGTH in.	WIDTH in.	THICKNESS in.	MAX. ATTACHMENT in.	B.L. lb	WEIGHT oz
Shocks™															
RF8080BLU	Blue	1.5 - 5.0	22.9	14.9	8.5	8mm wide.	350	2.5	1/16 - 3/16	7/8	9/16	5/16	5/16 wide.	770	0.1
RF8080GRY	Grey					5mm diameter							3/16 diameter		
RF8080R	Red														
Shocks™ XL															
RF8081BLU	Blue	3.0 - 10.0	36	24.8	14.5	10mm wide.	1000	12	1/8 - 3/8	1 7/16	1	9/16	3/8 wide.	2200	0.4
RF8081R	Red					10mm diameter							3/8 diameter		

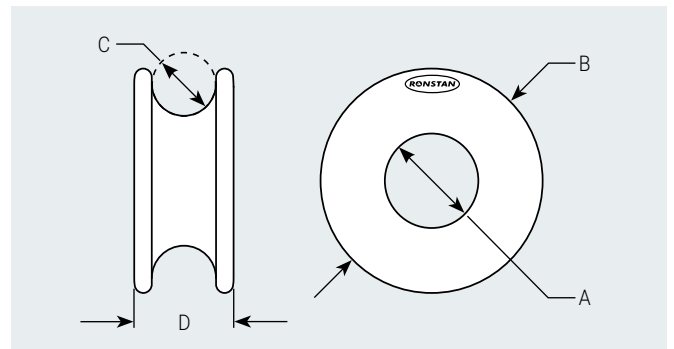
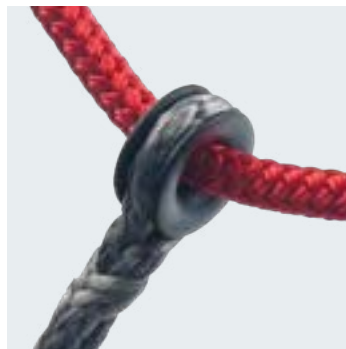
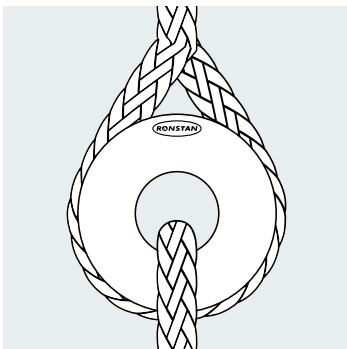

TYPICAL SETUP

- ✔ Compact, lightweight and low friction.
- ✔ Large secure shoulder for rope lashing.
- ✔ Simple and reliable - no moving parts.
- ✔ Low maintenance.
- ✔ Deflecting lead lines.
- ✔ Static load applications.
- ✔ Barber haulers, lazyjacks, backstays, cascading vang.
- ✔ Hard anodised aluminium.

PRODUCT No.	A mm	B mm	C mm	D mm	M.W.L. kg	WEIGHT g	A in	B in	C in	D in	M.W.L. lb	WEIGHT oz
Rings												
RF8090-05	5.0	15.0	4.5	7.5	500	2	3/16	19/32	3/16	9/32	1100	0.1
RF8090-08	8.0	22.0	7.0	11.0	1000	4	5/16	7/8	9/32	7/16	2200	0.1
RF8090-11	11.0	29.0	8.0	13.0	2000	8	7/16	1 5/32	5/16	1/2	4410	0.3
RF8090-16	16.0	38.0	11.0	17.0	3500	17	5/8	1 1/2	7/16	21/32	7720	0.6
RF8090-21	21.0	47.0	14.5	22.0	5000	33	13/16	1 27/32	9/16	7/8	11020	1.2
RF8090-26	26.0	57.0	16.0	25.0	7000	57	1 1/32	2 1/4	5/8	1	15430	2.0



© Junichi Hirai / Bulkhead Magazine



2 x 6mm (1/4")



2 x 6mm (1/4")



2 x 6mm (1/4")



2 x 8mm (5/16")

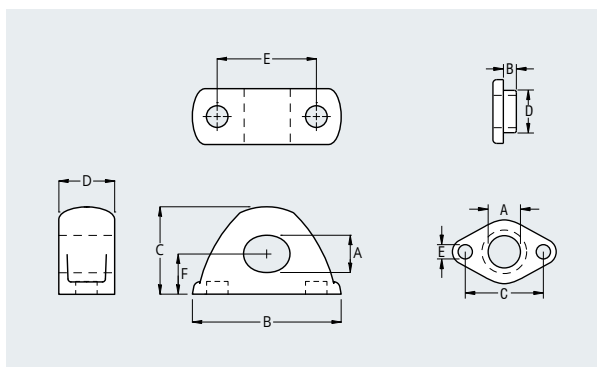

2 x 4mm (5/32")

- ✔ Compact, lightweight and low friction.
- ✔ Elliptical hole design tolerates alignment variations, makes threading lines easy.
- ✔ Simple and reliable design.
- ✔ Low maintenance.
- ✔ Deflection of sheets, halyards and control lines.
- ✔ Hard anodised aluminium.

PRODUCT No.	A	B	C	D	E	F	M.W.L.	WEIGHT	A	B	C	D	E	F	M.W.L.	WEIGHT
	mm	mm	mm	mm	mm	mm	kg	g	in	in	in	in	in	in	lb	oz
Fairleads																
RF8091-12	12	48	28	18	32	12	1000 ^{*1}	26	1/2	1 7/8	1 1/8	23/32	1 1/4	1/2	2200 ^{*1}	0.9
RF8091-16	16	60	32	22	39	12	1750 ^{*2}	38	5/8	2 3/8	1 1/4	7/8	1 17/32	1/2	3850 ^{*2}	1.3
RF8092-12	12	76	28	18	60	12	1000 ^{*1}	49	1/2	3	1 1/8	23/32	2 3/8	1/2	2200 ^{*1}	1.7
RF8093-12	12	104	28	18	88	12	1000 ^{*1}	75	1/2	4 3/32	1 1/8	23/32	3 15/32	1/2	2200 ^{*1}	2.7
RF8095-11	11	7	35	22	4	-	-	11	7/16	9/32	1 3/8	7/8	5/32	-	-	0.4

*1 MWL assumes evenly distributed upward pull on 2 x M6 fasteners.
 *2 MWL assumes evenly distributed upward pull on 2 x M8 fasteners.

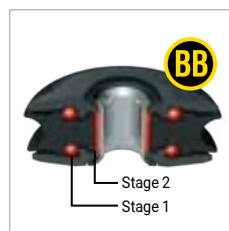

2-stage bearing system

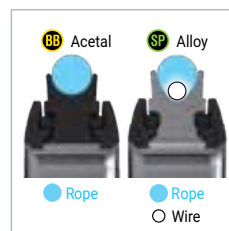

Sheave options



Aluminium alloy cheek plates

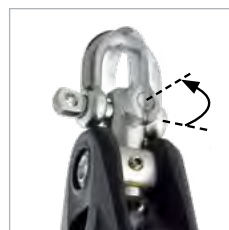

Universal head



Removable becket pins



Fully articulated stand-up

CORE BLOCKS™

USE THEM ANYWHERE

A balanced design approach incorporating functionality, performance and style makes our Core Blocks™ the right choice for performance cruising or racing applications. A tuned 2-stage bearing system provides excellent performance across the full working load range with an integrated thrust bearing feature and the resilience to handle high dynamic or static loads. Acetal & aluminium sheave options, alloy cheeks and stainless fixings complete the durable package.

BB Dynamic and high static load performance

Core Blocks™ incorporate our proven 2-stage bearing system.

Stage 1 - Under moderate loads, acetal ball bearings ensure minimum friction.

Stage 2 - Under heavy loads, where deformation of ball bearings alone would result in increased friction, a sliding acetal bearing on a polished stainless steel race takes over, maintaining low friction performance.

Additionally the ball bearings are configured to act as a thrust bearing between the sheave and cheeks, preventing the sheave from rubbing on the cheeks and causing friction when the line lead in and out of the block isn't perfect, particularly important for foot blocks.

Fully articulated stand-up

Stand-up models have a low profile linkage that provides full rotation and articulation. A high strength precision cast padeye minimises the footprint and a dedicated rubber boot ensures the block is held upright when not loaded.

Universal head

The head assembly incorporates a brass bearing washer to provide smooth 360° rotation of the post and shackle. A set screw arrangement allows the head to be locked at 0° or 90°. Shackles are high quality forged grade 316 stainless steel.

Aluminium alloy cheek plates

Block cheeks are manufactured from the highest quality aluminium alloy for maximum strength. Material optimisation and the cut-away design minimises weight and allows easy fresh water rinsing of salt and debris from the bearings. Cheek design has been further styled with flaring at the block throat and reduced gap between the cheek and sheave, minimising rope wear. The hollow hub can be used as a becket take-off or tie-up point.

Aluminium sheave option

SP models feature an aluminium sheave which has a deep groove profile ideal for use with rope or wire.

Suit pre-spliced lines

Removable becket pins allow fitting of pre-spliced lines. The flush fit becket pin head is kind on deck surfaces and won't snag lines.



Bearing system



Lashing Orbit Block™



Universal head



Stand-up block



Swivel-eye head blocks to suit padeyes

ORBIT BLOCKS™

SPECIFY THE BEST

Orbit Blocks™ are a no-compromise product range developed to meet the demands and expectations of the very dedicated and increasingly professional racing sailor, with characteristics including:

- High strength-to-weight ratio.
- Minimal friction loss, especially when working at high loads.
- Totally reliable and trouble free performance.
- Simplicity of design and construction to facilitate maintenance and servicing.
- Elegant, functional styling and finish.

BB Bearing system

The Orbit sheave has captive acetal or Torlon® ball bearings for side thrust loads, eliminating the need for side retainer plates. This reduces weight and allows for a wider bearing surface that can accommodate longer Torlon® needles – achieving a substantially higher strength-to-weight ratio.

Design simplicity

There are only 3 primary components to the block: the twin side pieces, sculptured from solid high grade alloy, and the one-piece sheave with its captive ball bearings. The Orbit sheave has captive acetal or Torlon® ball bearings for side thrust loads, maximising the available bearing surface for its Torlon® needle rollers to achieve a high strength-to-weight ratio.

Universal head

Head posts of swivel blocks can be locked at 0° or 90°. The high resistance shackles are forged in grade 17-4PH stainless steel.

Halyard blocks

These blocks have been designed primarily for attachment around the mast collar to lead halyards aft from the mast base to winches. The head of the block has a removable pin which enables easy attachment to the deck padeye or mast collar. This method of attachment provides a low lead aft to organisers or winches.

Strop and lashing blocks

These lightweight alternatives to traditional blocks are used where a rope lashing attachment is passed through the hub of the sheave to provide a failsafe feature. Lashing blocks have incredibly high breaking loads – up to 40,000kg. Their versatility makes them suitable for many applications, with four lashing guide holes to allow for multiple attachment options including single, parallel and split lashings. The central hole can also be used for a becket in 3:1 purchase systems. Every detail has been carefully executed to achieve the best optimisation of performance, size, weight and ultimate strength.

Foot blocks

The bottom plate incorporating the hub section is machined from solid alloy for maximum integrity of the load bearing structure. The top cover plate protects the sheave against impact, prevents dirt and grit from entering the hub area, and can be removed for service without removing the mounting bolts that secure the block through the base plate to the deck.

Stand-up blocks

A number of stand-up solutions are available for Orbit Blocks™. These include assemblies incorporating padeye and rubber boot, stand-up spring kits and blocks with special swivel-eye to suit non-tumble padeyes.





© Lutje Yachts

RF150
 4.8mm (3/16") pin

- ✔ High dynamic and static load capacity delivered by an efficient 2-stage bearing system. Ball bearings also counteract side thrust loads.
- ✔ Long service life; virtually maintenance free.
- ✔ Central hub hole can be used as a becket take-off point.
- ✔ RF44188 Halyard block incorporates a low profile swivel head fork with a removable screw pin for attaching to a padeye or 12mm (1/2") diameter mast collar post.

- ✔ RF44140 Stand-up block features a strong cast padeye base, and has a swivel head post to allow full rotation and articulation.
- ⚙ Mainsheet, halyard and spinnaker sheet applications on boats to 10m (33ft).
- ⚙ Various control line applications on larger yachts.

- ⚙ Sheave: UV stabilised acetal.
- ⚙ Cheek body: Aluminium alloy.
- ⚙ Ball bearings: High compression strength acetal.
- ⚙ Shackle, head post & hub: Grade 316 stainless steel.
- ⚙ Padeye: Grade 15-5PH stainless steel.
- ⚙ Fork pin: Grade 2205 stainless steel (RF44188).

PRODUCT No.	DESCRIPTION	SHEAVE DIAM.	MAX. ROPE	PIN	M.W.L.	B.L.	WEIGHT	SHEAVE	MAX. ROPE	PIN	M.W.L.	B.L.	WEIGHT
		mm	mm	DIAM.	kg	kg	g	DIAM.	in	DIAM.	lb	lb	oz
BB Ball Bearing													
RF44100	Single block, swivel shackle head	45	12	5	700	1400	104	1 3/4	1/2	3/16	1540	3090	3.6
RF44140	Stand-up block, swivelling	45	12	-	700	1400	151	1 3/4	1/2	3/16	1540	3090	5.3
RF44188	Halyard block, swivel fork head	45	12	5	700	1400	121	1 3/4	1/2	3/16	1540	3090	4.2
Accessories													
RF2429-02	Padeye, 34mm (1 5/16") diameter (see page 209)	-	-	-	-	1500*	26	-	-	-	1650	3300*	0.9
RF6170	Snap shackle head adapter	-	-	5	500	1000	49	-	-	3/16	1100	2200	1.7

* A4-80 DIN7991 grade fasteners recommended to achieve BL



- ✔ RF64140 stand-up block features a strong precision cast padeye base, and has a swivel head post to allow full articulation and rotation.
- ✔ RF64110 & RF64130 removable M8 (5/16") becket pin suits pre-spliced lines.
- ✔ RF64130 cleating angle is adjustable and is fitted with a high performance C-Cleat™ and fairlead for secure and easy cleating.
- ✔ RF64103 features a versatile trunion snap shackle that provides quick & simple attachment and removal, and has 360° rotation with side-to-side articulation.

- ⚙️ Mainsheet, halyard and spinnaker sheet applications on boats to 11m (36ft).
- ⚙️ Various control line applications on larger yachts.
- ⚙️ BB sheaves: UV stabilised acetal.
- ⚙️ SP sheaves: Anodised aluminium.
- ⚙️ Cheek plates & cleat arms: Aluminium alloy.
- ⚙️ Ball bearings: High compression strength acetal.

- ⚙️ Shackle, post & hub: Grade 316 stainless steel.
- ⚙️ Padeye & snap shackle: Grade 15-5PH stainless steel.
- ⚙️ Pins: Grade 2205 stainless steel (RF64108, RF64108A, RF64202).
- ⚙️ Cleat: Fibre reinforced composite.

PRODUCT No.	DESCRIPTION	SHEAVE	MAX.	MAX.	PIN	M.W.L.	B.L.	WEIGHT	SHEAVE	MAX.	MAX.	PIN	M.W.L.	B.L.	WEIGHT
		DIAM.	ROPE	WIRE	DIAM.	kg	kg	g	DIAM.	ROPE	WIRE	DIAM.	lb	lb	oz
		mm	mm	mm	mm				in	in	in	in	lb	lb	oz
RF618T	Twist shackle body, suits RF64202 & RF74202, for 90° attachment	-	-	-	-	-	-	40	-	-	-	-	-	-	1.4
RF64100	Single block, universal head	60	12	-	6	1000	2000	235	2 3/8	1/2	-	1/4	2200	4410	8.3
RF64103	Single block, trunion snap shackle head	60	12	-	-	1000	2000	285	2 3/8	1/2	-	-	2200	4410	10.1
RF64108	Halyard block, screw pin with roller head	60	12	-	8	1000 ¹	2000 ¹	186	2 3/8	1/2	-	5/16	2200 ¹	4410 ¹	6.6
RF64110	Single block, becket, universal head	60	12	-	6	1000	2000	275	2 3/8	1/2	-	1/4	2200	4410	9.7
RF64130	Single block, becket, cleat, universal head	60	12	-	6	1000 ²	2000	450	2 3/8	1/2	-	1/4	2200 ²	4410	15.9
RF64202	Double block, non-swivel shackle head	60	12	-	-	1000	2000	390	2 3/8	1/2	-	-	2200	4410	13.8

BB Ball Bearing

PRODUCT No.	DESCRIPTION	SHEAVE	MAX.	MAX.	PIN	M.W.L.	B.L.	WEIGHT	SHEAVE	MAX.	MAX.	PIN	M.W.L.	B.L.	WEIGHT
		DIAM.	ROPE	WIRE	DIAM.	kg	kg	g	DIAM.	ROPE	WIRE	DIAM.	lb	lb	oz
		mm	mm	mm	mm				in	in	in	in	lb	lb	oz
RF618T	Twist shackle body, suits RF64202 & RF74202, for 90° attachment	-	-	-	-	-	-	40	-	-	-	-	-	-	1.4
RF64100	Single block, universal head	60	12	-	6	1000	2000	235	2 3/8	1/2	-	1/4	2200	4410	8.3
RF64103	Single block, trunion snap shackle head	60	12	-	-	1000	2000	285	2 3/8	1/2	-	-	2200	4410	10.1
RF64108	Halyard block, screw pin with roller head	60	12	-	8	1000 ¹	2000 ¹	186	2 3/8	1/2	-	5/16	2200 ¹	4410 ¹	6.6
RF64110	Single block, becket, universal head	60	12	-	6	1000	2000	275	2 3/8	1/2	-	1/4	2200	4410	9.7
RF64130	Single block, becket, cleat, universal head	60	12	-	6	1000 ²	2000	450	2 3/8	1/2	-	1/4	2200 ²	4410	15.9
RF64202	Double block, non-swivel shackle head	60	12	-	-	1000	2000	390	2 3/8	1/2	-	-	2200	4410	13.8

SP Special Purpose - Aluminium Sheave

PRODUCT No.	DESCRIPTION	SHEAVE	MAX.	MAX.	PIN	M.W.L.	B.L.	WEIGHT	SHEAVE	MAX.	MAX.	PIN	M.W.L.	B.L.	WEIGHT
		DIAM.	ROPE	WIRE	DIAM.	kg	kg	g	DIAM.	ROPE	WIRE	DIAM.	lb	lb	oz
		mm	mm	mm	mm				in	in	in	in	lb	lb	oz
RF64100AW	Single block, rope/wire sheave, swivel shackle head	60	12	5	6	1000	2000	292	2 3/8	1/2	3/16	1/4	2200	4410	10.3
RF64108AW	Halyard block, rope/wire sheave, screw pin, roller head	60	12	5	8	1000 ¹	2000 ¹	212	2 3/8	1/2	3/16	5/16	2200 ¹	4410 ¹	7.5

*1 Full block rated load can only be achieved with uniformly distributed load across full length of screw pin. i.e. 14mm (9/16") diameter mast collar post or 14mm (9/16") wide mast collar plate/tang.

*2 Line load through cleat not to exceed 175kg (385lb).



RF64108A suits 14mm (9/16") mast collar post (not supplied)

RF617A
6mm (1/4") pin suits single & fiddle shackle head blocks

- ✔ RF64520 & RF64523 cleating angle is adjustable and are fitted with a high performance C-Cleat™ and fairlead for secure and easy cleating.
- ✔ Fiddle blocks incorporate an integrated becket through the hub of the lower sheave, and are ideal for creating simple vang and mainsheet systems up to 4:1 on boats to 12m (40ft).
- ✔ RF64503 & RF64523 features a versatile trunnion snap shackle with rotation and side-to-side articulation.

- ✔ RF64108A mast base block has a removable clevis pin to suit a 14mm (9/16") wide mast collar post.*
- ✔ Universal head can be fixed at 0° or 90° or left free to swivel, by using a 2.5mm hex key.
- ⚙ BB sheaves: UV stabilised acetal.
- ⚙ Cheek plates: Aluminium alloy.
- ⚙ Ball bearings: High compression strength acetal.

- ⚙ Shackle, post & hub: Grade 316 stainless steel.
- ⚙ Pins: Grade 2205 stainless steel (RF64108, RF64108A, RF64202).
- ⚙ Snap shackle & pad eye: Grade 15-5PH investment cast stainless steel.
- ⚙ Cleat: Fibre reinforced composite.

PRODUCT No.	DESCRIPTION	SHEAVE DIAM.	MAX. ROPE	MAX. WIRE	PIN DIAM.	M.W.L.	B.L.	WEIGHT	SHEAVE DIAM.	MAX. ROPE	MAX. WIRE	PIN DIAM.	M.W.L.	B.L.	WEIGHT
		mm	mm	mm	mm	kg	kg	g	in	in	in	in	lb	lb	oz
RF64108A	Mast base block, clevis pin head	60	12	-	8	1000 ^{*1}	2000 ^{*1}	182	2 3/8	1/2	-	5/16	2200 ^{*1}	4410 ^{*1}	6.4
RF64500	Fiddle block, universal head	60 + 30	12	-	6	1000	2000	355	2 3/8 + 1 3/16	1/2	-	1/4	2200	4410	12.5
RF64503	Fiddle block, snap shackle head	60 + 30	12	-	-	1000	2000	405	2 3/8 + 1 3/16	1/2	-	-	2200	4410	14.2
RF64520	Fiddle block, cleat, universal head	60 + 30	12	-	6	1000 ^{*3}	2000	490	2 3/8 + 1 3/16	1/2	-	1/4	2200 ^{*3}	4410	17.3
RF64523	Fiddle block, cleat, snap shackle head	60 + 30	12	-	-	1000 ^{*3}	2000	540	2 3/8 + 1 3/16	1/2	-	-	2200 ^{*3}	4410	19.0
RF64140	Stand-up block, swivelling	60	12	-	-	1000	2000	372	2 3/8	1/2	-	-	2200	4410	13.2
RF64151	Foot block, single	60	12	-	-	1000	2000	180	2 3/8	1/2	-	-	2200	4410	6.4
RF64251	Foot block, double	60	12	-	-	1000 ^{*2}	2000 ^{*2}	370	2 3/8	1/2	-	-	2200 ^{*2}	4410 ^{*2}	13.1

BB Ball Bearing

*1 Full block rated load can only be achieved with uniformly distributed load across full length of clevis pin. i.e. 14mm (9/16") diameter mast collar post or 14mm (9/16") wide mast collar plate/tang.
 *2 Total block load. Maximum load on top sheave not to exceed 50% of total block load.
 *3 Line load through cleat not to exceed 175kg (385lb).





- ✔ RF69110 removable becket pin allows lines to be spliced prior to fitting.
- ⬆ Primary mainsheet, halyard and spinnaker systems on boats to 12m (40ft).
- ⬆ Secondary mainsheet and vang systems on boats to 14m (46ft).
- ⬆ Permanent and running backstay systems on boats to 10m (33ft).
- ⬆ General control line and lead block applications on larger yachts.
- ⬆ Cheek plates: Fully machined aluminium alloy.
- ⬆ Sheave: Aluminium alloy.
- ⬆ Needle rollers: Torlon®.
- ⬆ Ball bearings: High compression strength acetal (RF69109A: Torlon®).
- ⬆ Forged shackle: Grade 17-4PH stainless steel.
- ⬆ Head post: Grade 316 stainless steel.

PRODUCT No.	DESCRIPTION	SHEAVE DIAM.	MAX. ROPE	PIN DIAM.	M.W.L.	B.L.	WEIGHT	SHEAVE DIAM.	MAX. ROPE	PIN DIAM.	M.W.L.	B.L.	WEIGHT
		mm	mm	mm	kg	kg	g	in	in	in	lb	lb	oz
BB Ball Bearing													
RF69000	Sheave with balls & rollers	60	12	-	-	-	65	2 3/8	1/2	-	-	-	2.3
RF69100	Single block, universal head	60	12	8	1800	4000	260	2 3/8	1/2	5/16	3970	8820	9.2
RF69108	Halyard block, screw pin head	60	12	9*2	1800	4000	160	2 3/8	1/2	3/8*2	3970	8820	5.6
RF69109	Strop block	60	12	-	1800	4000	148	2 3/8	1/2	-	3970	8820	5.2
RF69109A	Lashing block	60	12*1	-	2400	6000	160	2 3/8	1/2*1	-	5290	13220	5.7
RF69110	Single block, becket, universal head	60	12	8	1800	4000	290	2 3/8	1/2	5/16	3970	8820	10.2
RF69140	Stand-up block, 90 degree	60	12	-	1800	4000*3	398	2 3/8	1/2	-	3970	8820*3	14.0
RF69151	Foot block, single	60	12	-	1800	4000	190	2 3/8	1/2	-	3970	8820	6.7
RF69200	Double block, universal head	60	12	8	2250	4500	436	2 3/8	1/2	5/16	4960	9920	15.4
RF69209	Strop block, double	60	12	-	2250	4500	281	2 3/8	1/2	-	4960	9920	9.9

*1 10mm (3/8") is the maximum rope size if the hollow hub is to be used as a becket take-off.

*2 Bushed to 12mm (1/2") diameter.

*3 A4-80 DIN7991 grade fasteners recommended to achieve BL



RF618A
8mm (5/16") pin suits
single shackle head blocks

- ✓ Universal head can be fixed at 0° or 90° or left free to swivel, by using a 2.5mm hex key.
- ✓ RF74108 Halyard block has a removable 8mm (5/16") screw pin for attaching to mast collar or mainsail headboard.
- ✓ RF74108A Mast base block has removable 8mm (5/16") clevis pin to suit a 14mm (9/16") wide mast collar post.

- ⬆ Mainsheet, spinnaker sheet, vang, halyard and backstay applications on boats to 14m (46ft).
- ⬆ General applications on larger yachts.
- ⬆ Cheek plates: Aluminium alloy.
- ⬆ Sheave: UV stabilised acetal, or anodised aluminium (SP models).

- ⚙ Ball bearings: High compression strength acetal.
- ⚙ Shackle, post & hub: Grade 316 stainless steel.
- ⚙ Pins: Grade 2205 stainless steel (RF74108, RF74108A, RF74202).
- ⚙ Padeye: Grade 15-5PH stainless steel.

PRODUCT No.	DESCRIPTION	SHEAVE	MAX.	MAX.	PIN	M.W.L.	B.L.	WEIGHT	SHEAVE	MAX.	MAX.	PIN	M.W.L.	B.L.	WEIGHT
		DIAM.	ROPE	WIRE	DIAM.				DIAM.	ROPE	WIRE	DIAM.			
		mm	mm	mm	mm	kg	kg	g	in	in	in	in	lb	lb	oz
BB Ball Bearing															
RF618T	Twist shackle body, suits RF64202 & RF74202, for 90° attachment	-	-	-	-	-	-	40	-	-	-	-	-	-	1.4
RF74100	Single block, universal head	75	14	-	8	1500	3000	354	3	9/16	-	5/16	3300	6600	12.5
RF74108	Halyard block, screw pin with roller head	75	14	-	8	1500	3000	234	3	9/16	-	5/16	3300	6600	8.3
RF74108A	Mast base block, clevis pin head	75	14	-	8	1500 ^{*1}	3000 ^{*1}	230	3	9/16	-	5/16	3300 ^{*1}	6600 ^{*1}	8.1
RF74110	Single block, becket, universal head	75	14	-	8	1500	3000	428	3	9/16	-	5/16	3300	6600	15.1
RF74140	Stand-up block, swivelling	75	14	-	-	1500	3000	468	3	9/16	-	-	3300	6600	16.5
RF74151	Foot block, single	75	14	-	-	1500	3000	259	3	9/16	-	-	3300	6600	9.2
RF74202	Double block, non-swivel shackle head	75	14	-	-	1500	3000	506	3	9/16	-	-	3300	6600	17.9
RF74251	Foot block, double	75	14	-	-	1500 ^{*2}	3000 ^{*2}	530	3	9/16	-	-	3300 ^{*2}	6600 ^{*2}	18.7
SP Special Purpose - Aluminium Sheave															
RF74100AW	Single block, rope/wire sheave, universal head	75	14	8	8	1500	3000	432	3	9/16	5/16	5/16	3300	6600	15.3

*1 Full block rated load can only be achieved with uniformly distributed load across full length of clevis pin. i.e. 14mm (9/16") diameter mast collar post or 14mm (9/16") wide mast collar plate/tang.
*2 Total block load. Maximum load on top sheave not to exceed 50% of total block load.



1 x 8mm (5/16")
1 x 10mm (3/8")



RF324
RF2433-09*2
Suits RF79100 & RF79110

4 x 6mm (1/4")*2

Suits use with RF2437-12
removable lashing padeye. See
page 211 for details.

- ✔ RF79110 removable becket pin allows lines to be spliced prior to fitting.
- ⬆ Primary mainsheet, halyard and spinnaker systems on boats to 14m (46ft).
- ⬆ Secondary mainsheet, vang blocks on boats to 15m (50ft).
- ⬆ Permanent and running backstay systems on boats to 12m (40ft).
- ⬆ General control line and lead block applications on larger yachts.
- ⚙️ Cheek plates: Fully machined aluminium alloy.
- ⚙️ Sheave: Aluminium alloy.
- ⚙️ Needle rollers: Torlon®.
- ⚙️ Ball bearings: High compression strength acetal. (RF79109A: Torlon®)
- ⚙️ Forged shackle & head post: Grade 17-4PH stainless steel.

PRODUCT No.	DESCRIPTION	SHEAVE	MAX.	PIN	M.W.L.	B.L.	WEIGHT	SHEAVE	MAX.	PIN	M.W.L.	B.L.	WEIGHT
		DIAM.	ROPE	DIAM.	kg	kg	g	DIAM.	ROPE	DIAM.	lb	lb	oz
		mm	mm	mm				in	in	in	lb	lb	oz
BB RF79000	Sheave with balls & rollers	75	14	-	-	-	95	3	9/16	-	-	-	3.4
RF79100	Single block, universal head	75	14	8	2200	4500	340	3	9/16	5/16	4850	9920	12.0
RF79108	Halyard block, screw pin head	75	14	10 ^{*1}	2200	4500	251	3	9/16	3/8 ^{*1}	4850	9920	8.9
RF79109	Strop block	75	14	-	2200	4500	226	3	9/16	-	4850	9920	8.0
RF79109A	Lashing block	80	14	-	3100	7750	310	3 1/8	9/16	-	6830	17080	10.9
RF79110	Single block, becket, universal head	75	14	8	2200	4500	354	3	9/16	5/16	4850	9920	12.5
RF79140	Stand-up block, 90 degree	75	14	-	2000	4000 ^{*2}	480	3	9/16	-	4400	8820 ^{*2}	16.9
RF79151	Foot block, single	75	14	-	2200	4500	269	3	9/16	-	4850	9920	9.5
RF79200	Double block, universal head	75	14	8	3250	6500	575	3	9/16	5/16	7170	14330	20.3
RF79209	Strop block, double	75	14	-	3250	6500	414	3	9/16	-	7170	14330	14.6

*1 Bushed to 14mm (9/16") diameter.

*2 A4-80 DIN7991 grade fasteners recommended to achieve BL





RF104100 **BB**



RF104200 **BB**



RF104110 **BB**



RF104151 **BB**

2 x 12mm (7/16")

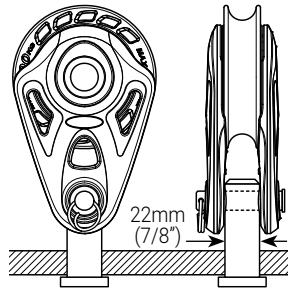

RF104108A suits 22mm (7/8") mast collar post (not supplied)



RF104108A **BB**

22mm (7/8")



RF104140 **BB**

4 x 8mm (5/16")*2

- ✔ Universal head can be fixed at 0° or 90° or left free to swivel, by using a 2.5mm hex key.
- ✔ RF104108A halyard block has removable 12mm (1/2") clevis pin to suit a 22mm (7/8") wide mast collar post.

- ⚙ Mainsheet, spinnaker sheet, vang, halyard and backstay applications on boats to 16m (53ft).
- ⚙ General applications on larger yachts.
- ⚙ Cheek plates: Aluminium alloy.
- ⚙ Sheaves: Glass fibre reinforced nylon.

- ⚙ Bearings: High compression strength, self-lubricating acetal.
- ⚙ Head post: Grade 2205 stainless steel.
- ⚙ Shackles: Grade 17-4PH stainless steel.
- ⚙ Padeye: Grade 15-5PH stainless steel.
- ⚙ Other fixtures: Grade 316 stainless steel.

PRODUCT No.	DESCRIPTION	SHEAVE DIAM.	MAX. ROPE	PIN DIAM.	M.W.L.	B.L.	WEIGHT	SHEAVE DIAM.	MAX. ROPE	PIN DIAM.	M.W.L.	B.L.	WEIGHT
		mm	mm	mm	kg	kg	g	in	in	in	lb	lb	oz
BB RF104100	Single block, universal head	100	18	10	3250	7500	900	4	3/4	3/8	7150	16500	31.8
RF104108A	Halyard block, clevis pin head	100	18	12	3250 ^{*1}	7500 ^{*1}	614	4	3/4	1/2	7150 ^{*1}	16500 ^{*1}	21.7
RF104110	Single block, becket, universal head	100	18	10	3250	7500	1098	4	3/4	3/8	7150	16500	38.8
RF104140	Stand-up block, swivelling	100	18	-	3000	6000 ^{*2}	1138	4	3/4	-	6600	13200 ^{*2}	40.2
RF104151	Foot block, single	100	18	-	3250	7500	700	4	3/4	-	7150	16500	24.7
RF104200	Double block, universal head	100	18	10	3250	7500	1400	4	3/4	3/8	7150	16500	49.5

*1 Full block rated load can only be achieved with uniformly distributed load across full length of clevis pin. i.e. 22mm (7/8") diameter mast collar post or 22mm (7/8") wide mast collar plate/tang.
*2 A4-80 DIN7991 grade fasteners recommended to achieve BL

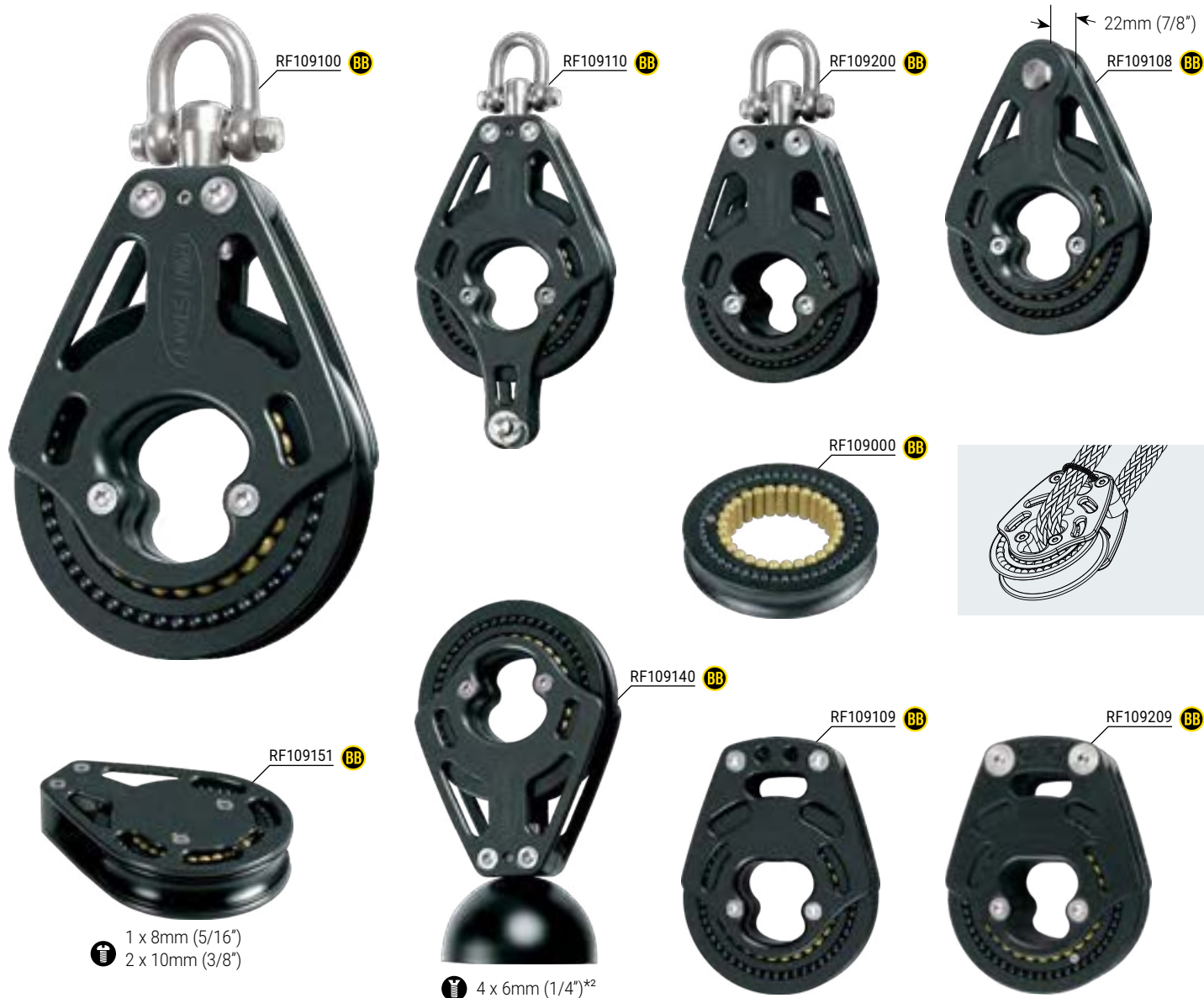

Suit use with RF2437-12 removable lashing padeye.
See page 211 for details.

- ✔ RF109110 removable becket pin allows lines to be spliced prior to fitting.
- ⬆ Primary mainsheet, halyard and spinnaker systems on boats to 15m (50ft).
- ⬆ Secondary mainsheet, vang blocks on boats to 18m (60ft).
- ⬆ Permanent backstay systems on boats to 14m (46ft).
- ⬆ General control line and lead block applications on larger yachts.
- ⬆ Cheek plates: Fully machined aluminium alloy.
- ⬆ Sheave: Aluminium alloy.
- ⬆ Needle rollers: Torlon®.
- ⬆ Ball bearings: High compression strength acetal.
- ⬆ Forged shackle & head post: Grade 17-4PH stainless steel.

PRODUCT No.	DESCRIPTION	SHEAVE	MAX.	PIN	M.W.L.	B.L.	WEIGHT	SHEAVE	MAX.	PIN	M.W.L.	B.L.	WEIGHT
		DIAM.	ROPE	DIAM.	kg	kg	g	DIAM.	ROPE	DIAM.	lb	lb	oz
		mm	mm	mm				in	in	in			
RF109000	Sheave with balls & rollers	100	14	-	-	-	180	4	9/16	-	-	-	6.3
RF109100	Single block, universal head	100	14	8	3000	6500	492	4	9/16	5/16	6610	14330	17.4
RF109108	Halyard block, screw pin head	100	14	12*1	3000	6500	391	4	9/16	1/2*1	6610	14330	13.8
RF109109	Strop block	100	14	-	3000	6500	361	4	9/16	-	6610	14330	12.8
RF109110	Single block, becket, universal head	100	14	8	3000	6500	530	4	9/16	5/16	6610	14330	18.7
RF109140	Stand-up block, 90 degree	100	14	-	2000	4000*2	600	4	9/16	-	4410	8820*2	21.2
RF109151	Foot block, single	100	14	-	3000	6500	447	4	9/16	-	6610	14330	15.8
RF109200	Double block, universal head	100	14	10	4250	8500	1030	4	9/16	13/32	9370	18740	36.3
RF109209	Strop block, double	100	14	-	4250	8500	732	4	9/16	-	9370	18740	25.9

*1 Bushed to 16mm (5/8") diameter.

*2 A4-80 DIN7991 grade fasteners recommended to achieve BL.



© Contest Yachts



RF109100A **BB**



RF109110A **BB**



RF109106A **BB**

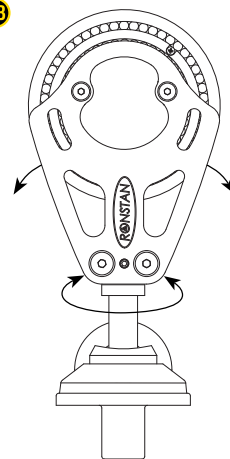

RF109106A suits RF2435-12B removable padeye. See page 210 for padeye options



RF109109A **BB**

Suits use with RF2437-16 removable lashing padeye. See page 211 for details.

- ✔ Exceptionally high strength-to-weight ratio.
- ✔ Captive ball bearings for side thrust loads.
- ✔ Head posts of swivel blocks can be locked at 0° or 90°.
- ✔ RF109110A removable becket pin allows lines to be spliced prior to fitting.

- ⬆ Primary mainsheet, halyard and spinnaker systems on boats to 18m (60ft).
- ⬆ Secondary mainsheet, vang blocks, spinnaker systems and halyards on boats to 22m (72ft).
- ⬆ Running backstay systems on boats to 16m (53ft).
- ⬆ General control line and lead block applications on larger yachts.

- ⚙ Cheek plates: Fully machined aluminium alloy.
- ⚙ Sheave: Aluminium alloy.
- ⚙ Needle rollers: Torlon®.
- ⚙ Ball bearings: High compression strength acetal. (RF109109A: Torlon®)
- ⚙ Forged shackle, head post & swivel eye: Grade 17-4PH stainless steel.

PRODUCT No.	DESCRIPTION	SHEAVE	MAX.	PIN/EYE	M.W.L.	B.L.	WEIGHT	SHEAVE	MAX.	PIN/EYE	M.W.L.	B.L.	WEIGHT
		DIAM.	ROPE	DIAM.	kg	kg	g	DIAM.	ROPE	DIAM.	lb	lb	oz
		mm	mm	mm				in	in	in			
BB RF109100A	Single block, universal head	100	16	10.0	4250	8500	720	4	5/8	3/8	9350	18700	25.4
RF109106A	Single block, swivel eye for stand-up	100	16	15.5	4000*	8000*	740	4	5/8	19/32	8800*	17600*	26.1
RF109109A	Lashing block	100	16	-	5500	13750	450	4	5/8	-	12120	30310	15.9
RF109110A	Single block, becket, universal head	100	16	10.0	4250	8500	790	4	5/8	3/8	9350	18700	27.9

* When used with the recommended padeye.



© Contest Yachts



RF129100A **BB**



RF129110A **BB**



RF129106A **BB**

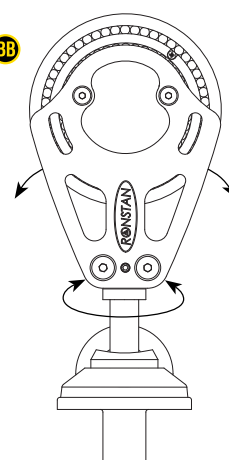

RF129106A suits RF2435-16B removable padeye. See page 210 for padeye options.



RF129109A **BB**

Suits use with RF2437-16 removable lashing padeye. See page 211 for details.



RF129151A **BB**

1 x 8mm (5/16")
2 x 12mm (7/16")

- ✔ Exceptionally high strength-to-weight ratio.
- ✔ Foot block cover plate can be removed for service access without removing fixing bolts.
- ✔ Head posts of swivel blocks can be locked at 0° or 90°.
- ✔ RF129110A removable becket pin allows lines to be spliced prior to fitting.

- ⚙ Primary mainsheet blocks on boats to 21m (69ft).
- ⚙ Secondary mainsheet blocks, spinnaker systems and halyards on boats to 25m (82ft).
- ⚙ Running backstay systems on boats to 18m (60ft).

- ⚙ Cheek plates: Fully machined aluminium alloy.
- ⚙ Sheave: Aluminium alloy.
- ⚙ Needle rollers: Torton®.
- ⚙ Ball bearings: High compression strength acetal. (RF129109A: Torton®)
- ⚙ Forged shackle, head post & swivel eye: Grade 17-4PH stainless steel.

PRODUCT No.	DESCRIPTION	SHEAVE	MAX.	PIN/EYE	M.W.L.	B.L.	WEIGHT	SHEAVE	MAX.	PIN/EYE	M.W.L.	B.L.	WEIGHT
		DIAM.	ROPE	DIAM.	kg	kg	g	DIAM.	ROPE	DIAM.	lb	lb	oz
		mm	mm	mm				in	in	in			
BB RF129100A	Single block, universal head	125	18	12.7	6000	12000	1240	5	3/4	1/2	13200	26400	43.7
RF129106A	Single block, swivel eye for stand-up	125	18	21.0	6000	12000	1360	5	3/4	13/16	13200	26400	48.0
RF129109A	Lashing block	125	18	-	6500	19500	930	5	3/4	-	14330	42990	32.8
RF129110A	Single block, becket, universal head	125	18	12.7	6000	12000	1330	5	3/4	1/2	13200	26400	46.9
RF129151A	Foot block, single	125	18	-	5000	10000	750	5	3/4	-	11020	22050	26.5



- ✔ Exceptionally high strength-to-weight ratio.
- ✔ Foot block cover plate can be removed for service access without removing fixing bolts.
- ✔ Head posts of swivel blocks can be locked at 0° or 90°.
- ✔ RF159110A removable becket pin allows lines to be spliced prior to fitting.

- ⚙ Mainsheet and genoa sheet systems on boats to 28m (92ft).
- ⚙ Spinnaker systems and halyards on boats to 31m (102ft).
- ⚙ Running backstay systems on boats to 28m (92ft).

- ⚙ Cheek plates: Fully machined aluminium alloy.
- ⚙ Sheave: Aluminium alloy.
- ⚙ Needle rollers: Torlon®.
- ⚙ Ball bearings: High compression strength acetal. (RF159109A: Torlon®)
- ⚙ Forged shackle, head post & swivel eye: Grade 17-4PH stainless steel.

PRODUCT No.	DESCRIPTION	SHEAVE DIAM.	MAX. ROPE	PIN/EYE	M.W.L.	B.L.	WEIGHT	SHEAVE DIAM.	MAX. ROPE	PIN/EYE	M.W.L.	B.L.	WEIGHT
		mm	mm	mm	kg	kg	g	in	in	in	lb	lb	oz
RF159100A	Single block, universal head	150	24	16.0	9000	18000	2310	6	1	5/8	19840	39600	81.5
RF159106A	Single block, swivel for stand-up	150	24	26.5	9000	18000	2080	6	1	1	19840	39600	73.4
RF159109A	Lashing block	150	24	-	9000	27000	1570	6	1	-	19840	59520	55.4
RF159110A	Single block, becket, universal head	150	24	16.0	9000	18000	2530	6	1	5/8	19840	39600	89.2
RF159151	Foot block, single	150	20	-	6500	14200	1285	6	3/4	-	14330	31310	45.3

BB Ball Bearing

- ⚙ 1 x 10mm (5/16")
- ⚙ 2 x 12mm (7/16")



© Contest Yachts



RF189109A **BB**



RF189151 **BB**

⚙ 1 x 16mm (5/8")
2 x 20mm (3/4")



RF189251 **BB**

⚙ 1 x 16mm (5/8")
2 x 20mm (3/4")

- ✔ Exceptionally high strength-to-weight ratio.
- ✔ Captive ball bearings for side thrust loads.
- ✔ Side cheeks incorporating head structure and hub are precision machined as a single part from solid alloy, leaving material only where it contributes to the load carrying capacity of the block and eliminating the need for additional fasteners.

- ✔ Foot block cover plate can be removed for service access without removing fixing bolts.
- ⚙ Mainsheet and genoa sheet systems on boats to 31m (102ft).
- ⚙ Spinnaker systems, halyards on boats to 33m (108ft).
- ⚙ Running backstay systems on boats to 32m (105ft).

- ⚙ Cheek plates: Fully machined aluminium alloy.
- ⚙ Sheave: Aluminium alloy.
- ⚙ Needle rollers: Torlon®.
- ⚙ Ball bearings: Torlon®.

PRODUCT No.	DESCRIPTION	SHEAVE	MAX.	PIN	M.W.L.	B.L.	WEIGHT	SHEAVE	MAX.	PIN	M.W.L.	B.L.	WEIGHT
		DIAM.	ROPE	DIAM.	kg	kg	g	DIAM.	ROPE	DIAM.	lb	lb	oz
		mm	mm	mm				in	in	in			
BB RF189109A	Lashing block, single	180	26	-	12000	30000	2450	7	1	-	26400	66000	89.9
RF189151	Foot block, single	180	22	-	9750	19500	2075	7	7/8	-	21500	42990	73.2
RF189251	Foot block, double	180	22	-	9750*	19500*	3710	7	7/8	-	21500*	42990*	130.9

* Total block load. Maximum load on top sheave not to exceed 50% of total block load



© www.afrancolini.com



- ✔ Exceptionally high strength-to-weight ratio.
- ✔ Captive ball bearings for side thrust loads.
- ✔ Side cheeks incorporating head structure and hub are precision machined as a single part from solid alloy, leaving material only where it contributes to the load carrying capacity of the block and eliminating the need for additional fasteners.

- ✔ Central hole can be used as a becket take-off/dead end in a 3:1 purchase system.
- ⚙️ Mainsheet and genoa sheet systems on boats larger than 34m (111ft).
- ⚙️ Spinnaker systems and halyards on boats larger than 33m (108ft).

- ⚙️ Running backstay systems on boats larger than 34m (111ft).
- ⚙️ Cheek plates: Fully machined aluminium alloy.
- ⚙️ Sheave: Aluminium alloy.
- ⚙️ Needle rollers: Torlon®.
- ⚙️ Ball bearings: Torlon®.

PRODUCT No.	DESCRIPTION	SHEAVE	MAX.	PIN	M.W.L.	B.L.	WEIGHT	SHEAVE	MAX.	PIN	M.W.L.	B.L.	WEIGHT
		DIAM.	ROPE	DIAM.	kg	kg	g	DIAM.	ROPE	DIAM.	lb	lb	oz
		mm	mm	mm				in	in	in			
RF209109A	Lashing block, single	200	28	-	15000	40000	3430	7 7/8	1 1/8	-	33000	88000	123.0

BB Ball Bearing

UPRIGHT & PIVOTING LOW LEAD BLOCKS



- ✔ High static and dynamic load capacity - BB models have Torlon® needle rollers for axial loads, and acetal ball bearings for side thrust loads.
- ✔ Upright lead blocks keep lines close to the deck.
- ✔ Cheek cut-outs for easy bearing cleaning and maintenance.
- ✔ Blocks can be disassembled for servicing.

PRODUCT No.	DESCRIPTION	SHEAVE DIAM. mm	MAX. ROPE mm	M.W.L. kg	B.L. kg	WEIGHT g	SHEAVE DIAM. in	MAX. ROPE in	M.W.L. lb	B.L. lb	WEIGHT oz
BB Ball Bearing											
RF68171	Upright lead block	60	14	1500	3000	222	2 3/8	9/16	3310	6610	7.8
RF68174	Pivoting low lead block	60	14	1500	3000	341	2 3/8	9/16	3310	6610	12.0
RF78171	Upright lead block	75	14	1990	3980	352	3	9/16	4390	8770	12.4
RF78174	Pivoting low lead block	75	14	1750	3500	470	3	9/16	3860	7720	16.6
RF108171	Upright lead block	100	14	2200	4400	517	4	9/16	4850	9700	18.2
RF128171	Upright lead block	125	16	3750	7500	777	5	5/8	8270	16530	27.4
RF158171	Upright lead block	150	20	5500	11000	1714	6	3/4	12130	24250	60.5

AP All Purpose											
RF61171	Upright lead block	60	14	1000	3000	205	2 3/8	9/16	2200	6610	7.2
RF61176	Over-the-top block	60	14	1000	3000	215	2 3/8	9/16	2200	6610	7.6
RF71171	Upright lead block	75	14	1500	3980	329	3	9/16	3310	8770	11.6

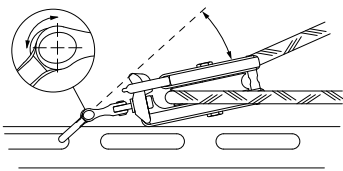

Trunnion articulation provides correct lead in restricted situations, such as toe-rail attachment.



- ✔ Convenient solution for temporary leads and line deflection.
- ✔ Easily operated secure latch mechanism.
- ✔ Soft resilient cheeks reduce clatter and protect gelcoat and painted surfaces.
- ✔ Snap shackle head allows block to swivel through 360°.
- ✔ Blocks with trunnion snap shackles allow additional articulation from side-to-side.

- ✔ Attachment point provided for a shock cord suspension line.
- ⚙ Temporary leads for sheets and reefing on boats up to 12m (40ft).
- ⚙ Spare or replacement block for general use on larger boats depending on line angle and load.
- ⚙ Temporary outboard sheet lead for headsail trimming.
- ⚙ Snap shackles: Investment cast grade 15-5PH stainless steel.

- ⚙ RF6730, RF6741: Grade 316 stainless steel frame, load strap and needle roller bearings; hard coat anodised alloy sheave; soft PVC cheeks.
- ⚙ RF6751: Grade 316 stainless steel frame, load strap, sheave and needle roller bearings; soft thermoplastic rubber cheeks.
- ⚙ RF6710, RF6711, RF6720, RF6721: Grade 316 stainless steel frame, load strap and hub; UV stabilised acetal sheaves; soft thermoplastic rubber cheeks.

PRODUCT No.	DESCRIPTION	SHEAVE DIAM.	MAX. ROPE	M.W.L.	B.L.	WEIGHT	SHEAVE DIAM.	MAX. ROPE	M.W.L.	B.L.	WEIGHT
		mm	mm	kg	kg	g	in	in	lb	lb	oz
AP All Purpose											
RF6710	Snatch block, swivel snap shackle head	51	12	425	850	250	2	1/2	935	1870	8.8
RF6711	Snatch block, trunnion snap shackle head	51	12	425	850	260	2	1/2	935	1870	9.2
RF6720	Snatch block, swivel snap shackle head	64	12	850	1700	480	2 1/2	1/2	1870	3750	16.9
RF6721	Snatch block, trunnion snap shackle head	64	12	850	1700	510	2 1/2	1/2	1870	3750	18.0
SP Special Purpose - Roller Bearings											
RF6730	Snatch block, aluminium sheave, roller bearings, swivel snap shackle head	45	16	1350	2700	550	1 3/4	5/8	2970	5940	19.4
RF6741	Snatch block, aluminium sheave, roller bearings, trunnion snap shackle head	45	16	1275	2550	610	1 3/4	5/8	2805	5610	21.5
RF6751	Snatch block, stainless steel sheave, roller bearings, trunnion snap shackle head	80	19	2500	5000	1480	3 1/8	3/4	5500	11000	52.2

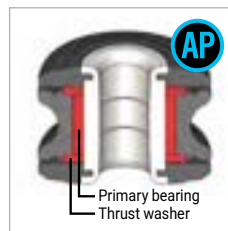

SA block sheave

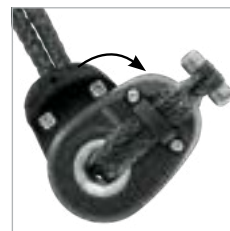

Cheek plates twist to open block

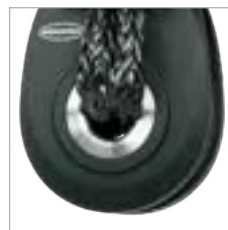

Self-lubricating composite journal bearing

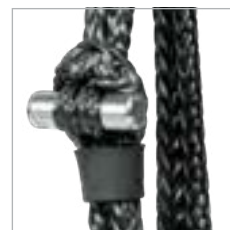

Soft shackle & titanium dog bone

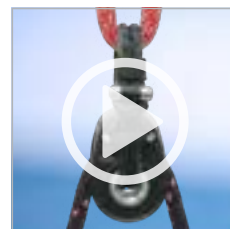

Watch Video

SA BLOCKS

SOFT ATTACHMENT BLOCKS

Designed from the outset to deliver outstanding performance, these blocks achieve the highest ratings for dynamic load vs sheave diameter in our keelboat block range. They are built to perform and built to last. Every SA Block features fully machined, anodised aluminium cheek plates. Sheaves run on duplex stainless steel hubs and incorporate precision composite journal bearings and thrust washers. The soft attachment is a purpose designed Dyneema® SK99 cord shackle with titanium dog bone.

Ultimate dynamic and static load performance

SA Blocks incorporate a full contact, self-lubricating composite journal bearing running on a polished duplex stainless steel hub, to maintain low friction performance under heavy dynamic and static loads. Thrust washers in the same composite material are positioned between the sheave and the cheek plates to handle the high side loads that can be generated when line entry and exit alignment is not ideal. Testing has shown reduced friction and greater durability than ball bearings in this application.

Attach, detach and open

The soft shackle provides a simple means of attachment, secured with the titanium dog bone but easily opened when necessary to detach the block. With the shackle open a gentle rotation of the cheek plates opens the head of the block so it can be fitted to a standing line. To close the block, rotate the cheeks back to the closed position until the spring loaded ball lock secures them in place. No additional external straps or bands required.

Soft shackle with titanium dog bone

Drawing on the expertise of Nodus Factory, many design iterations were tested before finalising specifications of the Dyneema® SK99 cord shackle and titanium dog bone. Proprietary Nodus Factory splicing techniques and fibre surface coating ensure secure load transfer from the block and maximum durability.

Aluminium alloy cheek plates & sheaves

Block cheeks and sheaves are precision machined from high strength aluminium alloy, anodised for durability and corrosion resistance. The soft attachment through the hub provides a protective buffer between the block and boat surfaces. Retaining guides in soft elastomer ensure that the block remains aligned within the soft shackle.

A multitude of applications

Suited to temporary or permanent line deflection, load carrying and snatch block applications including: 2:1 Main halyards, headsail and spinnaker sheets, mast base halyard deflection, and running backstays.

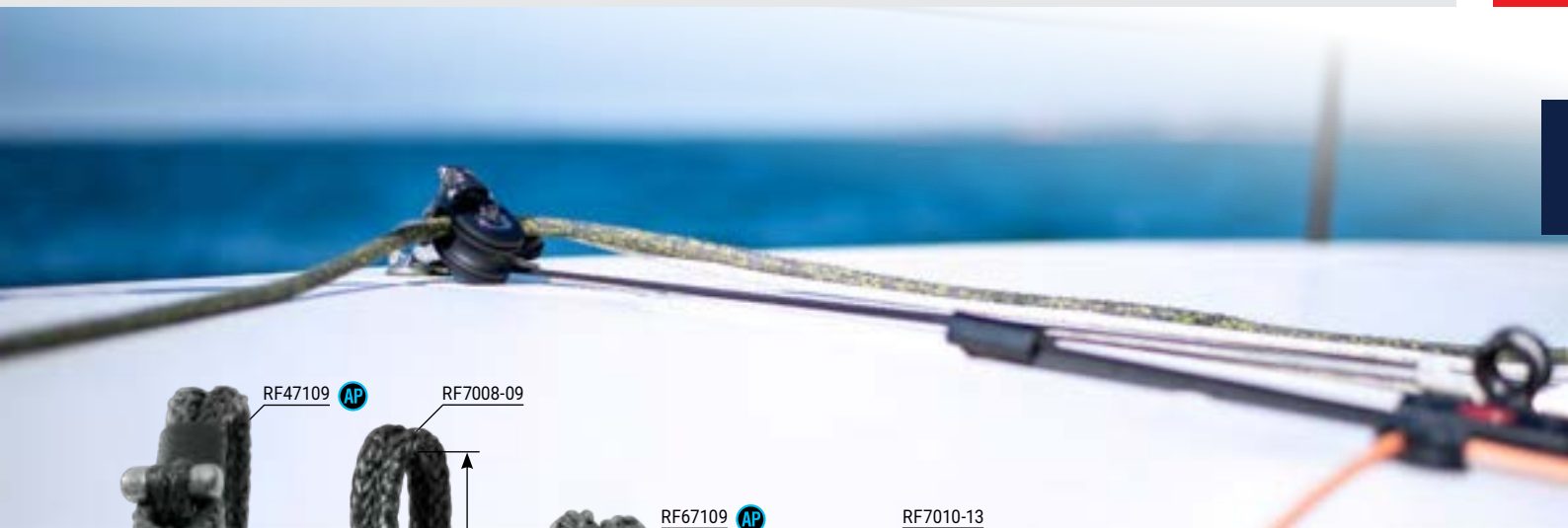

- ✔ Soft shackle retained by elastomer guides, titanium dog bone allows for easy attachment and removal of the block.
- ✔ Cheek plates twist to open the block, close with spring loaded ball lock securing in place.
- ✔ Primary bearing and thrust washers for optimum dynamic and static performance.
- ⚙️ Lead or floating blocks for headsail sheet trimming.
- ⚙️ Mast base blocks.
- ⚙️ Temporary lead blocks for sheet deflection, barber haulers and tack lines.
- ⚙️ 2:1 main halyards.
- ⚙️ Spare or replacement block for general use.
- ⚙️ Cheek plates and sheaves: Aluminium alloy, anodised.
- ⚙️ Bearings and thrust washers: Proprietary self-lubricating composite.
- ⚙️ Hubs: Grade 2205 stainless steel.
- ⚙️ Soft shackle: Dyneema® SK99 cord with proprietary coating, titanium dog bone, TPV collar.

PRODUCT No.	DESCRIPTION	SHEAVE	MAX.	M.W.L.	B.L.	WEIGHT	SHEAVE	MAX.	M.W.L.	B.L.	WEIGHT
		DIAM.	ROPE	kg	kg	g	DIAM.	ROPE	lb	lb	oz
		mm	mm				in.	in.			
AP All Purpose											
RF47109	Soft Attachment Block, Single, Snatch	42	12	2000	4000	165	1 5/8	1/2	4410	8820	5.8
RF67109	Soft Attachment Block, Single, Snatch	60	16	4000	8000	365	2 3/8	5/8	8820	17640	12.9
RF77109	Soft Attachment Block, Single, Snatch	75	19	7000	14000	753	2 15/16	3/4	15430	30860	26.6
RF7008-09	Soft Shackle, 6mm x 95mm, Suits RF47109	-	-	2000	4000	14	-	-	4410	8820	0.5
RF7010-13	Soft Shackle, 8mm x 135mm, Suits RF67109	-	-	4000	8000	30	-	-	8820	17640	1.1
RF7014-16	Soft Shackle, 10mm x 165mm, Suits RF77109	-	-	7000	14000	77	-	-	15430	30860	2.7

Dyneema® is a registered trademark of DSM IP Assets B.V.

BB ACETAL SHEAVE -
ACETAL BALL BEARINGS

BB ALUMINIUM SHEAVE -
TORLON® BALL BEARINGS

BB ALUMINIUM RATCHET SHEAVE -
ACETAL BALL BEARINGS

AP ACETAL
SHEAVE

AP GLASS REINFORCED
NYLON SHEAVE

SP NYLATRON®
SHEAVE

SP ALUMINIUM SHEAVE -
BRASS BEARING

BB BALL BEARING SHEAVES

- Ball bearings provide minimum friction under moderate loads.

AP ALL PURPOSE SHEAVES

- Acetal sheave models have high strength and utilise the self-lubricating properties of acetal.
- Glass reinforced nylon models have greater strength and abrasion resistance.

SP SPECIAL PURPOSE SHEAVES

- Nylatron® models utilise a cast partially cross-linked polyamide compound, modified with a MoS2 filler for lubrication and to minimise wear. They are suitable for use with wire or rope.
- Aluminium models have a self-lubricating brass bearing. They are suitable for use with wire or rope.

PRODUCT No.	BLOCK SUITED	DIAM. mm	BORE mm	WIDTH mm	MAX. ROPE mm	MAX. WIRE mm	WEIGHT g	DIAM. in	BORE in	WIDTH in	MAX. ROPE in	MAX. WIRE in	WEIGHT oz
BB Acetal - Ball Bearing													
RF15000		15.0	4.7	7.1	5	-	3	5/8	3/16	9/32	3/16	-	0.1
RF1020		28.0	5.0	11.1	6	-	6	1 1/8	3/16	7/16	1/4	-	0.2
RF35000		30.0	10.4	10.2	8	-	7	1 3/16	3/8	7/16	5/16	-	0.2
RF1766		38.0	8.0	15.0	10	-	15	1 1/2	5/16	19/32	3/8	-	0.5
RF1767		50.4	8.0	17.5	10	-	33	2	5/16	11/16	3/8	-	1.2
RF60000		60.0	3 x 6.2	16.6	10	-	50	2 3/8	3 x 7/32	21/32	3/8	-	1.8
RF70000		75.0	3 x 6.2	20.8	12	-	104	3	3 x 7/32	13/16	1/2	-	3.7
BB Aluminium - Ball Bearing													
RF34000		30.0	6.0	7.7	5	-	10	1 3/16	7/32	5/16	3/16	-	0.4
RF44000		40.0	6.0	10.1	6	-	15	1 9/16	7/32	13/32	1/4	-	0.5
RF62000	Series 60 Ultimate Ratchet	60.0	3 x 6.1	16.6	10	-	45	2 3/8	3 x 7/32	21/32	3/8	-	1.6
RF72000	Series 75 Ultimate Ratchet	75.0	3 x 6.1	20.8	12	-	95	3	3 x 7/32	13/16	1/2	-	3.4
AP Acetal													
RF1741		19.0	6.6	6.4	6	-	1	3/4	1/4	1/4	1/4	-	0.1
RF1743		19.0	8.2	9.5	6	-	2	3/4	5/16	3/8	1/4	-	0.1
RF578		25.0	6.5	9.5	6	-	4	1	1/4	3/8	1/4	-	0.1
RF1746		26.0	9.8	12.0	8	-	5	1	3/8	15/32	5/16	-	0.2
RF128		28.0	8.1	15.2	12	-	7	1 1/8	5/16	19/32	1/2	-	0.2
RF129		28.0	6.6	9.9	8	-	6	1 1/8	1/4	3/8	5/16	-	0.2
RF41000		40.0	8.1	14.4	10	-	15	1 9/16	5/16	9/16	13/32	-	0.5
RF1006	Series 40 Deck Organisers	38.0	12.7	15.5	12	-	21	1 1/2	1/2	19/32	1/2	-	0.7
RF1751		38.0	8.2	10.2	6	-	10	1 1/2	11/32	13/32	1/4	-	0.4
RF1759		50.0	8.1	15.6	14	-	22	1 15/16	11/32	19/32	9/16	-	0.8
RF437		59.0	11.0	19.0	16	-	43	2 5/16	7/16	3/4	5/8	-	1.5
RF1765		66.0	8.2	15.1	5	-	35	2 5/8	11/32	15/32	3/16	-	1.2
RF431*		73.0	13.0	22.0	14	-	97	2 7/8	15/32	7/8	9/16	-	3.4
RZ1000	Series 75 Industrial	75.0	21.7	20.5	14	-	70	2 15/16	7/8	13/16	9/16	-	2.5
AP Glass Reinforced Nylon													
PNP98JR		75.0	13.0	15.8	10	-	59	2 15/16	15/32	19/32	3/8	-	2.1
PNP98KR		100.0	13.0	19.0	12	-	80	3 15/16	15/32	3/4	1/2	-	2.8
SP Nylatron®													
RF20000HL		20.0	8.1	8.8	6	3	2	3/4	5/16	3/8	1/4	1/8	0.1
RF430	RF468	25.0	6.5	7.0	5	5	10	1	1/4	9/32	3/16	3/16	0.4
RF30000HL		30.0	8.1	11.4	8	3	6	1 3/16	5/16	7/16	5/16	1/8	0.2
RF40000HL		40.0	8.1	13.4	10	4	15	1 1/2	5/16	17/32	3/8	5/32	0.5
RF132	RF103, RF104	45.0	8.0	9.5	-	6	33	1 3/4	5/16	3/8	-	1/4	1.2
RF50000HL		50.0	10.2	18.0	12	5	28	1 31/32	13/32	23/32	1/2	3/16	1.0
SP Aluminium - Brass Bearing													
RZ1000AW	Series 75 Industrial	75.0	21.7	20.2	-	8	190	-	7/8	13/16	-	5/16	6.7

* Acetal sheave with bronze bearing



AP ALL PURPOSE SHEAVES

- Sheave: UV stabilised acetal.
- Hub bush: Grade 316 stainless steel.

BB BALL BEARING SHEAVES

- Sheave: Aluminium alloy.
- Needle rollers: Torlon® (RF68000: PEEK, RF68000W: acetal).
- Ball bearings: High compression strength acetal.

PRODUCT No.	DESCRIPTION	SHEAVE DIAM. mm	WIDTH mm	MAX. ROPE mm	M.W.L. kg	WEIGHT g	SHEAVE DIAM. in	WIDTH in	MAX. ROPE in	M.W.L. lb	WEIGHT oz
BB Ball Bearing											
RF68000	Sheave	60	20.5	14	1500	85	2 3/8	13/16	9/16	3310	3.0
RF68000W	Sheave, wide	60	33.0	25	1150	128	2 3/8	1 5/16	1	2540	4.5
RF78000	Sheave	75	20.5	14	1750	142	3	13/16	9/16	3850	5.0
RF78000W	Sheave, wide	75	41.5	25	2800	280	3	1 5/8	1	6160	9.9
RF108000	Sheave	100	20.5	14	2000	262	4	13/16	9/16	4400	9.2
RF108000W	Sheave, wide	100	41.5	25	3900	497	4	1 5/8	1	8600	17.5
RF128000	Sheave	125	20.5	16	3000	448	5	13/16	5/8	6600	15.8
RF128000W	Sheave, wide	125	41.5	32	6650	817	5	1 5/8	1 1/4	14660	28.8
RF158000	Sheave	150	27.5	20	5000	739	6	1 3/32	3/4	11000	26.1
RF158000W	Sheave, wide	150	41.5	32	8100	1164	6	1 5/8	1 1/4	17860	41.1
AP All Purpose											
RF61000	Sheave	60	20.5	14	1000	67	2 3/8	13/16	9/16	2200	2.4
RF71000	Sheave	75	20.5	14	1500	128	3	13/16	9/16	3310	4.5



RF5121
2 x 4mm (5/32")

RF5100
2 x 4mm (5/32")

RF5105
2 x 5mm (3/16")

RF5110
2 x 6mm (1/4")

RF5101
2 x 4mm (5/32")

RF5106
2 x 5mm (3/16")

2:1 ADJUSTABLE TRAPEZE SYSTEM

RF5101, RF5106 BECKET TAKE-OFF FOR SIMPLE 2:1 PURCHASE SYSTEM

- ✔ Lightweight.
- ✔ Low, snag-free profile.
- ✔ Base profile suits mounting on flat and curved surfaces.
- ✔ Cut-away in base of RF5101 and RF5106 fairlead cleats can be used as a becket for a 2:1 purchase system (refer diagram above).
- ✔ RF5121 trapeze Clamcleat® is made from hard anodised alloy and incorporates a roller for easy 2:1 adjustment under load (refer diagram above).
- ✔ Control lines on dinghies and catamarans.
- ✔ PTFE impregnated, abrasion resistant glass and carbon fibre composite cleats.
- ✔ Hard anodised alloy RF5121.

PRODUCT No.	DESCRIPTION	FASTENER SIZE	HOLE SPACING	ROPE SIZE	WEIGHT	FASTENER SIZE	HOLE SPACING	ROPE SIZE	WEIGHT
		mm	mm	mm	g	in	in	in	oz
Cleats									
RF5100	V-Cleat®, small, open	4	36	3-6	9	5/32	1 7/16	1/8-1/4	0.3
RF5101	V-Cleat®, small, fairlead	4	48	3-6	11	5/32	1 7/8	1/8-1/4	0.4
RF5105	V-Cleat®, medium, open	5	55	5-8	23	3/16	2 5/32	3/16-5/16	0.8
RF5106	V-Cleat®, medium, fairlead	5	66	5-8	27	3/16	2 9/16	3/16-5/16	1.0
RF5110	V-Cleat®, large, open	6	72	8-12	51	1/4	2 13/16	5/16-1/2	1.8
RF5121	Trapeze cleat, Aluminium	-	-	4-8	46	-	-	5/32-5/16	1.6

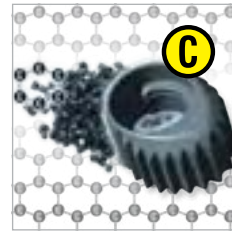

Carbon fibre cam C-Cleat™

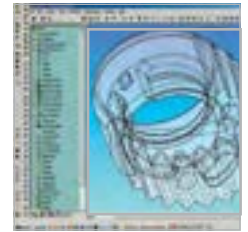

Design optimisation



Effective slotted bearings



Multi-coil spring



Low line entry effort

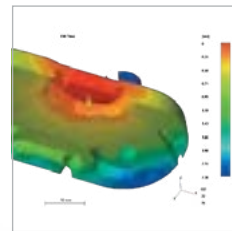

Advanced composite base



Swivel cleat base

C-CLEATS™ & T-CLEATS™

ENGINEERED FOR PERFORMANCE

Intensive development efforts have produced this high performance range of cam cleats that provides unbeatable holding power while allowing easy cleating and releasing of control lines and sheets.

C Carbon cam C-Cleats™

C-Cleats™ feature lightweight, ultra-rigid, carbon fibre composite cams that are corrosion free, wear resistant and non-abrasive.

T T-Cleats™

T-Cleats™ have hard wearing glass fibre reinforced cams for reliable cleating. They offer a great value solution for moderately demanding applications.

A Alloy cam cleats

Aluminium cam models built for ultimate durability where high wear and high loads are encountered. Cams are hot-forged and hard anodised for maximum strength and corrosion resistance. Ronstan alloy cam cleats are built on an aluminium base for maximum rigidity and are available in size medium.

Advanced composite base

Cleat bases are produced from long fibre reinforced polymer to save weight while providing essential stiffness.

Slotted bearings

Self-lubricating, self-cleaning slotted bearings provide lower frictional resistance, quicker response times and superior resistance to sand and salt than ball bearings which can deform under load.

Multi-coil spring

The multi-coil spring recessed in the upper part of the cam generates near constant torque. This consistency ensures secure cleating of even the smallest diameter lines with minimal abrasion or rope wear.

Unique teeth and entry profiles

Low effort line entry and exit due to unique teeth and entry geometry.

Customisation

A comprehensive range of specialist cleat accessories allow customisation of the cleat setup to optimise performance by controlling inward lead, outward lead, cleating and uncleating angle and height.

Total control

Swivel cleat bases further enhance the function of cleats by providing articulation. Some models provide adjustable cleating angles for even further functionality and accessibility.



ACCESSORIES



SADDLE

FAIRLEADS

ROPE GUIDE

WEDGE KIT

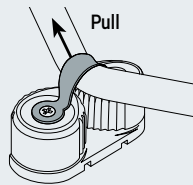

SADDLE
Retains line near cleat

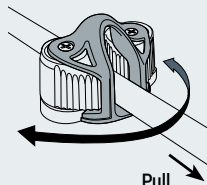

FAIRLEAD
Assists clearing from different positions

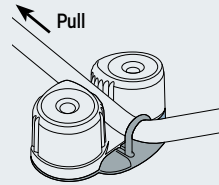

ROPE GUIDE
Corrects lead of line into cleat from loaded side.

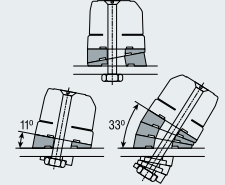

WEDGE KITS
Are stackable for greater angles or to act as a riser.

- ✔ Design, materials selection and advanced manufacturing methods combine to deliver superior strength and holding power, light weight and corrosion resistance.
- ✔ C-Cleat™ carbon fibre composite cam material provides high resistance to heat and abrasion.

- ✔ Unique self-cleaning, self-lubricating slotted bearings ensure consistent high performance even when subjected to high static loads.
- ✔ Cam profile and multi-coil spring minimise line entry and release effort.

- ⚙ C-Cleats™
 - Carbon fibre composite cams.
 - Long strand glass fibre reinforced polymer base.
- ⚙ T-Cleat™
 - Glass fibre composite cams.
 - Long strand glass fibre reinforced polymer base.

PRODUCT No.	CAP	ROPE CAPACITY	HOLE SPACING	FASTENER SIZE	DIMENSIONS	M.W.L.	B.L.	WEIGHT	ROPE CAPACITY	HOLE SPACING	FASTENER SIZE	DIMENSIONS	M.W.L.	B.L.	WEIGHT
		mm	mm	mm					mm	mm	mm				
Ⓢ C-Cleats™															
RF5000	Grey	2-8	27	M4	48L x 24W x 20H	75	150	20	3/32-5/16	1 1/16	5/32	1 7/8L x 1W x 3/4H	165	330	0.7
RF5400	Black	2-8	27	M4	48L x 24W x 20H	75	150	20	3/32-5/16	1 1/16	5/32	1 7/8L x 1W x 3/4H	165	330	0.7
RF5400B	Blue	2-8	27	M4	48L x 24W x 20H	75	150	20	3/32-5/16	1 1/16	5/32	1 7/8L x 1W x 3/4H	165	330	0.7
RF5400G	Green	2-8	27	M4	48L x 24W x 20H	75	150	20	3/32-5/16	1 1/16	5/32	1 7/8L x 1W x 3/4H	165	330	0.7
RF5400R	Red	2-8	27	M4	48L x 24W x 20H	75	150	20	3/32-5/16	1 1/16	5/32	1 7/8L x 1W x 3/4H	165	330	0.7
RF5400Y	Yellow	2-8	27	M4	48L x 24W x 20H	75	150	20	3/32-5/16	1 1/16	5/32	1 7/8L x 1W x 3/4H	165	330	0.7
Ⓢ T-Cleat™															
RF5001	Red	2-8	27	M4	48L x 24W x 20H	75	150	20	3/32-5/16	1 1/16	5/32	1 7/8L x 1W x 3/4H	165	330	0.7

MEDIUM CAM CLEATS



ACCESSORIES



- ✔ Design, materials selection and advanced manufacturing methods combine to deliver superior strength and holding power, light weight and corrosion resistance.
- ✔ C-Cleat™ carbon fibre composite cam material provides high resistance to heat and abrasion.

- ✔ Unique self-cleaning, self-lubricating slotted bearings ensure consistent high performance even when subjected to high static loads.
- ✔ Cam profile and multi-coil spring minimise line entry and release effort.

- ✔ C-Cleats™
 - Carbon fibre composite cams.
 - Long strand glass fibre reinforced polymer base.
- ✔ T-Cleat™
 - Glass fibre composite cams.
 - Long strand glass fibre reinforced polymer base.

PRODUCT No.	CAP	ROPE CAPACITY mm	HOLE SPACING mm	FASTENER SIZE mm	DIMENSIONS mm	M.W.L. kg	B.L. kg	WEIGHT g	ROPE CAPACITY in	HOLE SPACING in	FASTENER SIZE in	DIMENSIONS in	M.W.L. lb	B.L. lb	WEIGHT oz
C-Cleats™															
RF5010	Grey	3-12	38	M5	66L x 31W x 26H	125	250	50	1/8-1/2	1 1/2	3/16	2 5/8L x 1 1/4W x 1H	275	550	1.8
RF5410	Black	3-12	38	M5	66L x 31W x 26H	125	250	50	1/8-1/2	1 1/2	3/16	2 5/8L x 1 1/4W x 1H	275	550	1.8
RF5410B	Blue	3-12	38	M5	66L x 31W x 26H	125	250	50	1/8-1/2	1 1/2	3/16	2 5/8L x 1 1/4W x 1H	275	550	1.8
RF5410G	Green	3-12	38	M5	66L x 31W x 26H	125	250	50	1/8-1/2	1 1/2	3/16	2 5/8L x 1 1/4W x 1H	275	550	1.8
RF5410R	Red	3-12	38	M5	66L x 31W x 26H	125	250	50	1/8-1/2	1 1/2	3/16	2 5/8L x 1 1/4W x 1H	275	550	1.8
RF5410Y	Yellow	3-12	38	M5	66L x 31W x 26H	125	250	50	1/8-1/2	1 1/2	3/16	2 5/8L x 1 1/4W x 1H	275	550	1.8
T-Cleat™															
RF5011	Red	3-12	38	M5	66L x 31W x 26H	125	250	50	1/8-1/2	1 1/2	3/16	2 5/8L x 1 1/4W x 1H	275	550	1.8
Alloy Cam Cleat															
RF5510R	Red	3-12	38	M5	66L x 31W x 26H	125	250	70	1/8-1/2	1 1/2	3/16	2 5/8L x 1 1/4W x 1H	275	550	2.5



© Michael Aepli / Quant Boats



- ✔ Design, materials selection and advanced manufacturing methods combine to deliver superior strength and holding power, light weight and corrosion resistance.
- ✔ Carbon fibre composite cam material provides high resistance to heat and abrasion.

- ✔ Unique self-cleaning, self-lubricating slotted bearings ensure consistent high performance even when subjected to high static loads.
- ✔ Cam profile and multi-coil spring minimise line entry and release effort.

- ⚙ Carbon fibre composite cams.
- ⚙ Long strand glass fibre reinforced polymer base.

PRODUCT No.	CAP	ROPE CAPACITY mm	HOLE SPACING mm	FASTENER SIZE mm	DIMENSIONS mm	M.W.L. kg	B.L. kg	WEIGHT g	ROPE CAPACITY in	HOLE SPACING in	FASTENER SIZE in	DIMENSIONS in.	M.W.L. lb	B.L. lb	WEIGHT oz
C-Cleats™															
RF5020	Grey	6-16	51	M6	88L x 41W x 35H	230	460	110	1/4-5/8	2	1/4	3 1/2L x 1 5/8W x 1 3/8H	510	1010	3.9
RF5420	Black	6-16	51	M6	88L x 41W x 35H	230	460	110	1/4-5/8	2	1/4	3 1/2L x 1 5/8W x 1 3/8H	510	1010	3.9
RF5420B	Blue	6-16	51	M6	88L x 41W x 35H	230	460	110	1/4-5/8	2	1/4	3 1/2L x 1 5/8W x 1 3/8H	510	1010	3.9
RF5420G	Green	6-16	51	M6	88L x 41W x 35H	230	460	110	1/4-5/8	2	1/4	3 1/2L x 1 5/8W x 1 3/8H	510	1010	3.9
RF5420R	Red	6-16	51	M6	88L x 41W x 35H	230	460	110	1/4-5/8	2	1/4	3 1/2L x 1 5/8W x 1 3/8H	510	1010	3.9
RF5420Y	Yellow	6-16	51	M6	88L x 41W x 35H	230	460	110	1/4-5/8	2	1/4	3 1/2L x 1 5/8W x 1 3/8H	510	1010	3.9

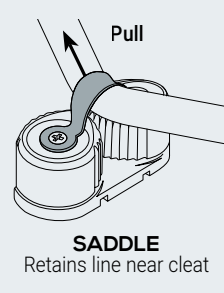

SWIVEL CLEAT BASES

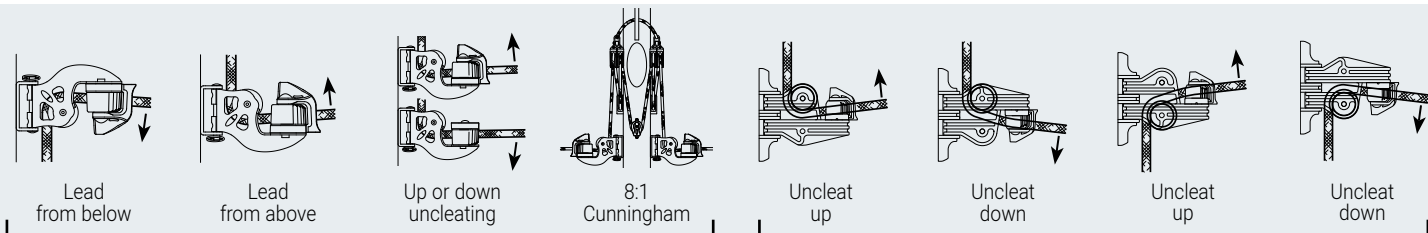

RF20175 LEAD AND CLEATING OPTIONS

RF5 LEAD AND CLEATING OPTIONS

- ✓ Swivel cleat bases provide easy cleating and releasing from any angle.
- ✓ The RF60 features adjustable stops to limit rotation, which can be removed to allow full 360° rotation.
- ✓ Cleating plates are heavy gauge alloy for stiffness and minimum distortion under load.

- ✓ Deadeyes have flared stainless steel liners for minimum rope wear and long service life.
- ✓ The RF5 is manufactured in lightweight fibre reinforced composite materials – the position of the sheave can be changed for control line led from below.

- ⬆ Sheet leads and control lines on dinghies and catamarans.
- ⬆ Cunningham, vang, foreguy, pole topping lift and other control lines on larger yachts.
- ⚙ Alloy cleating arms.
- ⚙ Fibre reinforced nylon body (RF5).
- ⚙ Grade 316 stainless steel fixtures.

PRODUCT No.	DESCRIPTION	SUITS ROPE mm	WEIGHT g	SUITS ROPE in	WEIGHT oz
Swivel Cleat Bases					
RF4	Swivel shackle base. Suits Series 40 & 55 Orbit Block™ Dyneema® links. 4.8mm (3/16") diameter pin. MWL 250kg (550lb), BL 500kg (1100lb)	-	30	-	1.1
RF5	Swivelling cleat unit. 28mm (1 1/8") diameter ball bearing sheave, small C-Cleat™ and fairlead. Maximum line load 125kg (275lb)	2 – 8	100	3/32 – 5/16	3.5
RF58	Swivelling deadeye & cleat unit. Aluminium arm, 360° rotation, medium C-Cleat™ & fairlead. Maximum line load 175kg (385lb)	3 – 12	171	1/8 – 1/2	6.0
RF60	Swivelling deadeye & cleat unit. Aluminium arm, adjustable rotation stops, medium C-Cleat™ & fairlead. Maximum line load 175kg (385lb)	3 – 12	257	1/8 – 1/2	9.1
RF67	Swivelling deadeye & cleat unit. Aluminium arm, 360° rotation, small C-Cleat™ & fairlead. Maximum line load 125kg (275lb)	2 – 8	121	3/32 – 5/16	4.3
RF70	Swivelling cleat unit, 15mm sheaves. Stainless steel arm, 360° rotation, small C-Cleat™ & fairlead. Maximum line load 125kg (275lb)	2 – 5	146	3/32 – 3/16	5.1
RF1455	Swivel base with block post socket. 4.8mm (3/16") diameter pin. Suits shackle head Series 40 & 50 Utility blocks and Series 55 Orbit Blocks™. MWL 200kg (440lb); BL 1000kg, (2200lb)	-	65	-	2.3
RF20175	Swivelling cleat unit. 20mm (3/4") sheave with stainless steel ball bearings, small C-Cleat™ & fairlead. Maximum line load 125kg (275lb)	2 – 6	79	3/32 – 1/4	2.8



RF6

4 x 5mm (3/16")

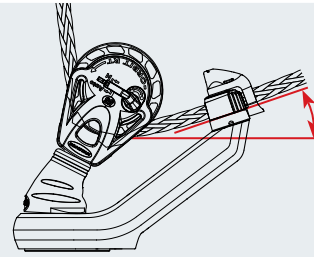

Lower clearing angle

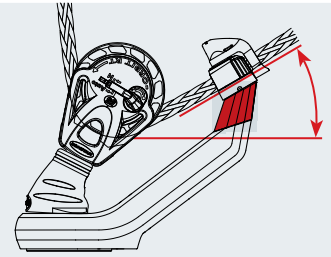

Higher clearing angle with cleat riser fitted to arm

Stand-up boot cut down to suit. See instructions in SUPPORT section of www.ronstan.com for full details

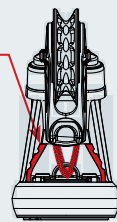

Soft attachment (Dyneema® link) block attachment

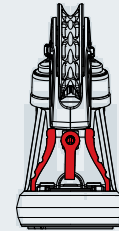

Shackle head block attachment

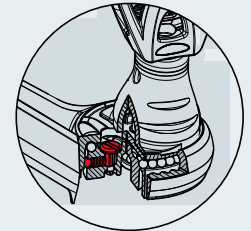

Ball bearing race minimises friction. Switchable ratchet system prevents the arm from swinging to leeward.



RF7

4 x 5mm (3/16")

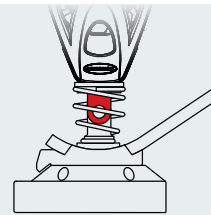

Conventional shackle head block - discard shackle and plastic roller

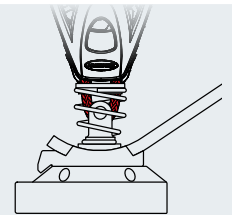

Dyneema® link head Orbit Block™ - use supplied plastic roller when attaching Dyneema® link.

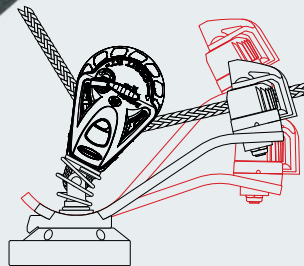

Height adjustable arm for optimum clearing angle.

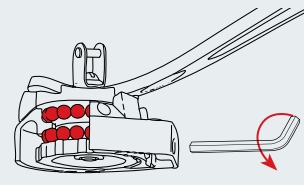

Twin ball bearing races minimise friction. Adjustable ratchet system prevents the arm from falling to leeward.

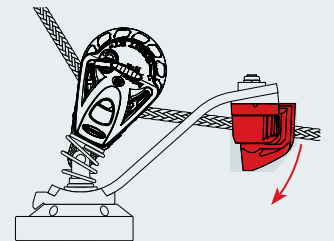

Cleat and wedge kit can be mounted on underside of arm for downward unclearing if preferred.

- ✔ Adjustable height and angle of clearing arm for optimum control.
- ✔ Twin rows of ball bearings support the clearing arm. Stops are provided to limit rotation.
- ✔ A ratchet in the base allows the clearing arm to remain in its most recently used position. The ratchet can be turned off for free swivelling.

- ✔ Suits traditional post/shackle head blocks and Dyneema® link head Orbit Blocks™*2.
- ⚙️ RF6 is suitable for mainsheet systems on dinghies to 4.5m (15ft).
- ⚙️ RF7 is suitable for mainsheet systems on dinghies and sports boats to 8m (26ft).

- ⚙️ RF6: glass fibre reinforced base and cleat arm.
- ⚙️ RF7: glass fibre reinforced base and alloy clearing arm.
- ⚙️ Grade 316 stainless steel fixings and block attachment points.

PRODUCT No.	DESCRIPTION	M.W.L.*1 kg	B.L.*1 kg	WEIGHT g	M.W.L.*1 lb	B.L.*1 lb	WEIGHT oz
RF6	Small ball bearing swivelling cleat base, small C-Cleat™, loop take-off	125	250	210	275	550	7.4
RF7	Ball bearing swivelling cleat base, medium C-Cleat™, 5mm (3/16") pin	215	430	342	473	946	12.1

*1 Load rating are for the cleat base assembly, and are based on a 120° change in line direction. Line loads should be limited to: RF6 M.W.L. 125kg (275lb), RF7 M.W.L. 175kg (385lb).
*2 RF7 swivel fork has a 5mm (3/16") pin and 11.8mm (7/16") gap to permit direct, low profile attachment to the head post of a block.







© X-Yachts



RF494



RF520
RF521
RF522
RF523
RF524



RF1387

PRODUCT No.	DESCRIPTION	ROPE DIAM. mm	HOLE SPACING mm	FASTENER SIZE mm	M.W.L. kg	WEIGHT g	ROPE DIAM. in	HOLE SPACING in	FASTENER SIZE in	M.W.L. lb	WEIGHT oz
Rope Cleats and Jammers											
RF494	V-jammer, stainless steel, 69mm (2 3/4") long	6	56	2 x 4	-	14	1/4	2 7/32	2 x 3/16	-	0.5
RF520	Horn cleat, nylon, 75mm (3") long	4	25	2 x 5	-	10	5/32	1	2 x 3/16	-	0.4
RF521	Horn cleat, nylon, 100mm (4") long	5	28	2 x 5	-	15	3/16	1 3/32	2 x 3/16	-	0.5
RF522	Horn cleat, nylon, 125mm (5") long	6	38	2 x 6	-	30	1/4	1 1/2	2 x 1/4	-	1.1
RF523	Horn cleat, nylon, 165mm (6 1/2") long	8	41	2 x 6	-	50	5/16	1 5/8	2 x 1/4	-	1.8
RF524	Horn cleat, nylon, 200mm (8") long	10	48	2 x 6	-	85	3/8	1 29/32	2 x 1/4	-	3.0
RF1387	Rope jammer, compact style. 60mm (2 3/8") long. Supplied with two base plates, for use with 4-6mm (5/32"-1/4") diameter rope and 6-8mm (1/4"-5/16") diameter rope	4 - 8	45	2 x 6	410	165	5/32 - 5/16	1 25/32	2 x 1/4	900	5.8



Lightweight carbon extension grip

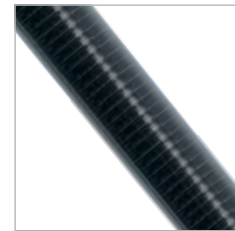

Tapered carbon tube optimises weight



Lightweight EVA grip & end knob



Lightweight & rigid aluminium tube



Full-articulation universal joint

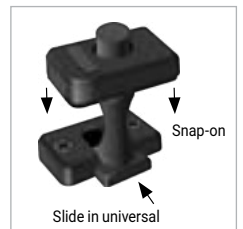

Removable urethane universal joint

BATTLESTICK™ TILLER EXTENSIONS

ULTIMATE PERFORMANCE AND CONTROL

Ronstan Battlestick™; the next generation of sailing weaponry. A range of carbon composite and alloy tiller extensions providing the highest level of control for quick, decisive helm response in every situation.

Carbon Battlestick™ positive grip

The unique lightweight grip remains effective when wet and its slim profile transitions smoothly from the carbon tube to a comfortable ergonomic shape to minimise fatigue. The ribbed finish on the tube provides additional positive grip along its full length, and an end stop is fitted for comfort and safety. Short tiller extensions have smaller grip diameters to match typically smaller hands.

Lightweight & strong

The dual laminate construction has been precisely engineered for minimum weight, without sacrificing the durability required to meet the rigours of modern sailing. A combination of full length longitudinal and 45° lateral glass and carbon fibres balance optimum stiffness with extra resilience to resist breakage.

Tapered carbon composite tube

The tapered design maximises rigidity and strength at the helmsman's end for positive feel and resistance to breakage over the gunwale when things get ugly.

Alloy Battlestick™ ergonomic EVA grip

This firm non-slip grip material does not absorb water and the large grip diameter contrasts ergonomically with mainsheet diameter to relieve fatigue. The end knob ensures safety and positive hand positioning.

Fluted alloy tube

Ronstan's aluminium tiller extensions have a unique fluted profile that adds extra rigidity to the lightweight alloy section. Tubes have a black anodised finish for corrosion protection.

The right length

Battlesticks™ are available in six standard lengths from 610mm to 2500mm (24" to 98") to suit virtually any class or personal preference. To facilitate cutting of the tube to a custom length the 2500mm (98") RF3137C does not include a grip or end cap. Telescopic alloy versions are available in four configurations, up to the maximum of 2500mm (98") long with 960mm (38") of adjustment.

Urethane universal joint

The universal joint in high grade, UV resistant urethane provides smooth, uniform articulation and flexibility in all directions for a quick and firm response to steering.

BATTLESTICK™ TILLER EXTENSIONS

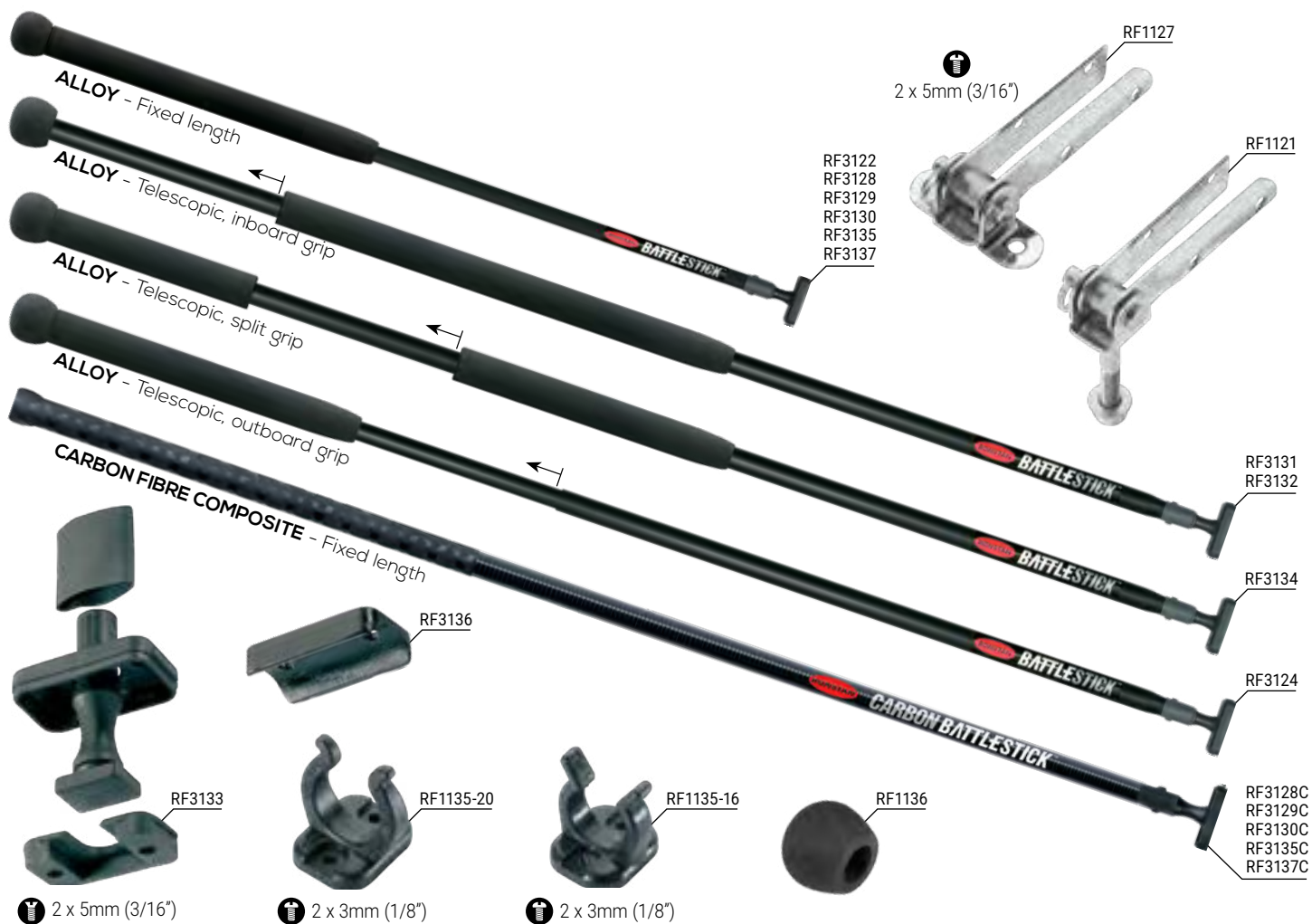

PRODUCT No.	DESCRIPTION	LENGTH mm	TUBE DIAM. mm	GRIP DIAM. mm	WEIGHT g	LENGTH in	TUBE DIAM. in	GRIP DIAM. in	WEIGHT oz
-------------	-------------	--------------	------------------	------------------	-------------	--------------	------------------	------------------	--------------

Carbon Fibre Tiller Extensions

RF3128C	Carbon fibre, tapered, fixed length	610	16 > 20	22	108	24	5/8 > 3/4	7/8	3.8
RF3129C	Carbon fibre, tapered, fixed length	840	16 > 22	24	137	33	5/8 > 7/8	1	4.8
RF3130C	Carbon fibre, tapered, fixed length	1030	16 > 23	25	155	41	5/8 > 7/8	1	5.5
RF3135C	Carbon fibre, tapered, fixed length	1250	16 > 24	26	179	49	5/8 > 1	1	6.3
RF3137C*	Carbon fibre, tapered, fixed length	2500	16 > 25	-	310	98	5/8 > 1	-	10.9

Alloy Tiller Extensions

RF3128	Alloy, fixed length	610	16	25	150	24	5/8	1	5.3
RF3129	Alloy, fixed length	840	16	25	180	33	5/8	1	6.4
RF3130	Alloy, fixed length	1030	16	25	215	41	5/8	1	7.6
RF3135	Alloy, fixed length	1250	16	25	260	49	5/8	1	9.2
RF3122	Alloy, fixed length	2030	16	25	415	80	5/8	1	14.7
RF3137	Alloy, fixed length	2500	16	25	515	98	5/8	1	18.2
RF3134	Alloy, telescopic, split grip	740 - 1120	16 + 20	30	310	29 - 44	5/8 + 3/4	1 1/4	10.9
RF3131	Alloy, telescopic, inboard grip	740 - 1210	16 + 20	30	285	29 - 48	5/8 + 3/4	1 1/4	10.1
RF3132	Alloy, telescopic, inboard grip	1070 - 1770	16 + 20	30	400	42 - 70	5/8 + 3/4	1 1/4	14.1
RF3124	Alloy, telescopic, outboard grip	1530 - 2490	16 + 20	30	485	60 - 98	5/8 + 3/4	1 1/4	17.1

Accessories

RF1121	Stainless steel bolt-through universal joint. Suits 16mm (5/8") OD tube. Incorporating 1/4" UNCx1 3/4" (45mm) long bolt	-	64	-	-	-	-	-	2.3
RF1127	Stainless steel screw down universal joint. Suits 16mm (5/8") OD tube	-	56	-	-	-	-	-	2.0
RF1135-16	Nylon tiller extension retaining clip. Suits 16mm (5/8") dia. tube	-	7	-	-	-	-	-	0.2
RF1135-20	Nylon tiller extension retaining clip. Suits 20mm (3/4") dia. tube	-	4	-	-	-	-	-	0.1
RF1136	Tiller extension end knob, EVA foam, suits 16mm (5/8") OD tube	-	35	-	-	-	-	-	1.2
RF3133	Urethane universal joint. Suits 13.5mm (17/32") ID tube	-	35	-	-	-	-	-	1.2
RF3136	Round tiller adapter for RF3133. Suits 25-32mm (1-1 1/4") tiller	-	7	-	-	-	-	-	0.2

* Grip and end cap not included.

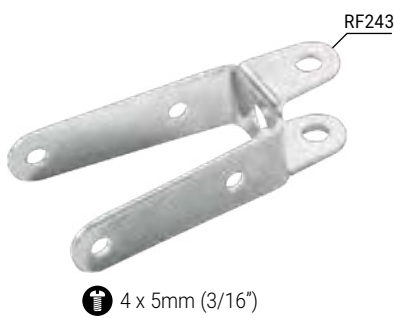

✔ Pintle pins are cross-drilled to accept the RF413 retaining clip.

✔ PNP55 retaining clip for transom mounting provides simple rudder retention security.

⚠ Off-the-beach dinghies and catamarans.

PRODUCT No.	DESCRIPTION	PIN/HOLE DIAM. mm	INTERNAL WIDTH mm	STRAP LENGTH mm	WEIGHT g	PIN/HOLE DIAM. in	INTERNAL WIDTH in	STRAP LENGTH in	WEIGHT oz
6.4mm (1/4") Pin/Hole									
RF239	Rudder gudgeon, stainless steel	6.4	38	51	40	1/4	1 1/2	2	1.4
RF243	Rudder gudgeon, stainless steel	6.4	25	56	35	1/4	1	2 3/16	1.2
RF254	Transom gudgeon, stainless steel	6.4	-	-	31	1/4	-	-	1.1
RF255	Transom pintle, stainless steel	6.4	-	-	45	1/4	-	-	1.6
Accessories									
PNP55	Retaining clip, transom mount, nylon	-	-	-	5	-	-	-	0.2
RF413	Retaining clip, 2.7mm (3/32") diameter wire, 16mm(5/8") ID, stainless steel	-	-	-	3	-	-	-	0.1





Dominic & Steve Randall, International Cadet

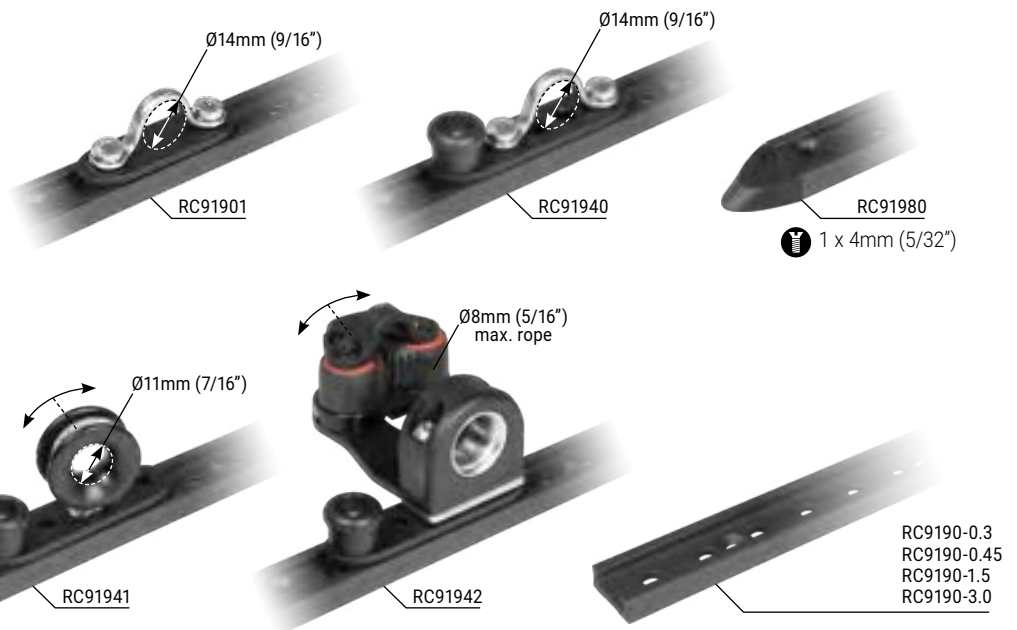
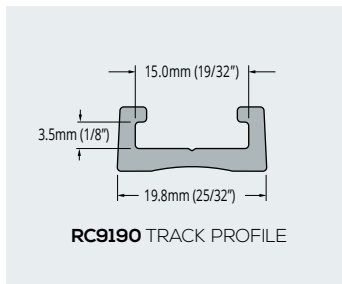

RF1058
Suits RC91944

- ✓ Spring-loaded plunger stops allow fast, positive positioning of track slides.
- ✓ Slides are available with swivelling cleat and fairlead to suit different crewing positions.
- ✓ RC91942 features a small cam cleat and fairlead and suits line sizes 2-8mm (3/32-5/16").

RF134
Suits RC91901 & RC91940

- ✓ RC91941 RopeGlide™ ring has a 'soft' attachment which allows up to 250° rotation.
- ⬆ Dinghy and small catamaran jib sheet leads.
- ⬆ Dinghy outhauls.

- ⚙ Grade AL6061-T6 aluminium alloy track.
- ⚙ Glass fibre reinforced nylon slides.
- ⚙ Grade 316 stainless steel fixtures.

SERIES 19 TRACK FASTENINGS – 4mm (5/32") countersunk fasteners at 75mm (2 15/16") centres. **STOP HOLES** – 19mm (3/4") centres

PRODUCT No.	DESCRIPTION	LENGTH	M.W.L.	B.L.	WEIGHT	LENGTH	M.W.L.	B.L.	WEIGHT
		mm	kg	kg	g	in	lb	lb	oz
Series 19									
RC9190-0.3	Track	296	-	-	64	11 5/8	-	-	2.3
RC9190-0.45	Track	446	-	-	96	17 9/16	-	-	3.4
RC9190-1.5	Track	1496	-	-	321	58 7/8	-	-	11.3
RC9190-3.0	Track	2996	-	-	643	117 5/16	-	-	22.7
RC91901	Slide, saddle	57	220	440	26	2 1/4	485	970	0.9
RC91940	Slide, saddle, plunger stop	71	220	440	33	2 13/16	485	970	1.2
RC91941	Slide, soft-attached ring, plunger stop	71	100	200	28	2 13/16	220	440	1.0
RC91942	Slide, swivelling fairlead & cleat, plunger stop	71	100*	200*	115	2 13/16	220*	440*	4.1
RC91944	Slide, saddle with ferrule eye, plunger stop	71	220	440	40	2 13/16	485	970	1.4
RC91980	Track end, plastic (2 pack)	19	-	-	2	3/4	-	-	0.1

*Line load through cleat



© James Hill



Removable lead block



Ergonomic plunger stop operation

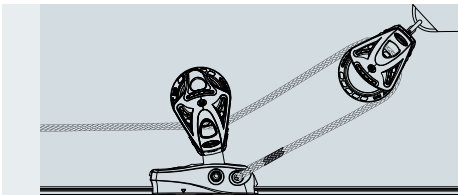

INTEGRATED BECKET FOR 2:1 SHEET SYSTEM

- ✔ Low profile and lightweight, T-Track is a simple, reliable system for adjustable sheet leads.
- ✔ Composite slides have a removable attachment pin to suit either a Dyneema® link or a shackle.
- ✔ Composite slides have an integrated becket for 2:1 headsail sheet systems, popular on modern sport boats.
- ✔ Composite slides have a spring-loaded push button plunger stop for fast, positive positioning.
- ✔ Stand-up blocks on composite slides provide optimum alignment and low profile lead.
- ✔ The main pin recess in the RC72504 composite slide can accept up to 8mm (5/16") line attached directly to the pin.
- ✔ A convenient all inclusive racing kit is available for sportsboats (RC72540S).
- ⚡ RC72537S suitable for headsail sheet leads on boats up to 8m (26ft).
- ⚡ RC72536S & RC72533S suitable for headsail sheet leads on boats up to 7m (23ft).
- ⚡ Toughened, glass fibre reinforced nylon slide.
- ⚡ Grade AL6061-T6 aluminium alloy track.
- ⚡ Grade 316 stainless steel ring (RC72544).

TRACK FASTENINGS – 5mm (3/16") countersunk fasteners at 100mm (3 15/16") centres. **STOP HOLES** - 25mm (63/64") centres for Racing track, 50mm (1 31/32") on all other tracks.

PRODUCT No.	DESCRIPTION	LENGTH	M.W.L.	B.L.	WEIGHT	LENGTH	M.W.L.	B.L.	WEIGHT
		mm	kg	kg	g	in	lb	lb	oz
RC72536S	Composite slide, Series 40 BB Orbit Block™, stand-up, suits up to 9mm (5/16") rope, plunger stop	102	325	700	152	4	715	1540	5.4
RC72537S	Composite slide, Series 55 BB Orbit Block™, stand-up, suits up to 10mm (3/8") rope, plunger stop	102	500	1000	193	4	1100	2200	6.8
RC72540S	Racing Kit, including 2 x 465mm (18 5/16") racing tracks, 2 x composite slides with Series 55 BB Orbit Block™, 4 x track ends, 10 x track bolt insulators	-	500	1000	842	-	1100	2200	29.8

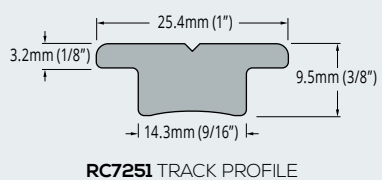

RF134
Suits RC72505, RC72506 & RC72533S

PRODUCT No.	DESCRIPTION	LENGTH	M.W.L.	B.L.	WEIGHT	LENGTH	M.W.L.	B.L.	WEIGHT
		mm	kg	kg	g	in	lb	lb	oz
Slides									
RC72504	Composite slide, removable M4 pin, plunger stop	102	500	1000	107	4	1100	2200	3.8
RC72505	Composite slide, saddle, plunger stop	80	400	800	72	5 5/32	880	1765	2.5
RC72506	Composite slide, saddle	67	400	800	57	2 5/8	880	1765	2
RC72533S	Composite slide, Series 40 AP block, stand-up, suits up to 10mm (7/16") rope, plunger stop	80	400	800	137	5 5/32	880	1765	4.8
RC72541	Composite slide, RopeGlide™ Ring, 16mm (5/8") internal dia.	102	500	1000	120	4	1100	2200	4.2
RC72544	Composite spinnaker pole slide ring, plunger stop	102	400	800	215	4	880	1760	7.6
Accessories									
RC7250-INS	Track bolt insulator	-	-	-	3	-	-	-	0.1
RC72581	Track end, plastic	-	-	-	5	-	-	-	0.2
RF9004-13	Dyneema® link, 4mm x 130mm (5/32" x 5 1/8")	130	-	-	4	5 1/8	-	-	0.1
Track - Supplied with RC7250-INS nylon track bolt insulators									
RC7251-0.5A	Racing track, black, 25mm (63/64") stop hole centres	465	-	-	188	18 5/16	-	-	6.6
RC7251-1.0A	Racing track, black, 25mm (63/64") stop hole centres	996	-	-	405	39 3/16	-	-	14.2
RC7251-1.5	Track, black, 50mm (1 31/32") stop hole centres	1496	-	-	631	58 7/8	-	-	22.2
RC7251-2.0	Track, black, 50mm (1 31/32") stop hole centres	1996	-	-	841	78 9/16	-	-	29.7
RC7251-3.0	Track, black, 50mm (1 31/32") stop hole centres	2996	-	-	1263	117 15/16	-	-	44.5



- ✔ The lead block on RC73234 and RC73235 articulates for ideal sheet alignment and have an integrated anti-clatter rubber buffer.
- ✔ RC73231, RC73234 Jib sheet leads suit boats to 12m (40ft).

- ✔ RC73235 Jib sheet leads suit boats to 10m (33ft).
- ✔ RC73231 genoa car can accommodate two sheets for easy headsail changes, and has a plunger stop that can be locked in the "up" position.

- ⚙ Grade AL6061-T6 aluminium alloy track.
- ⚙ Grade 316 stainless steel slide bodies.
- ⚙ UV stabilised acetal sheaves.
- ⚙ Nylon slide liners.

TRACK FASTENINGS – 6mm (1/4") countersunk fasteners at 100mm (3 15/16") centres. **STOP HOLES** – 50mm (1 31/32") centres

PRODUCT No.	DESCRIPTION	LENGTH mm	M.W.L. kg	B.L. kg	WEIGHT g	LENGTH in	M.W.L. lb	B.L. lb	WEIGHT oz	
Series 32 T-Track										
RC00476	Slide liners (pair), nylon, suits RC73201, RC73202, RC73243	107	-	-	7	4 7/32	-	-	0.3	
RC00477	Slide liners (pair), nylon, suits RC73231	152	-	-	11	6	-	-	0.4	
RC00478	Slide liners (pair), nylon, suits RC73234	107	-	-	7	4 7/32	-	-	0.3	
RC7320-INS	Track bolt insulator	-	-	-	3	-	-	-	0.1	
RC73201	Slide, loop top	102	1000 ²	2000 ²	185	4	2200 ²	4400 ²	6.5	
RC73202	Slide, loop top, plunger stop	102	1000 ²	2000 ²	240	4	2200 ²	4400 ²	8.5	
RC73231	Genoa car, 50mm (2") AP sheave, suits two 16mm (5/8") sheets, lock up/down plunger stop	146	1500	3000	480	5 3/4	3300	6600	17.0	
RC73234	Genoa car, S60 BB Core Block™, suits 12mm (1/2") sheet, lock up/down plunger stop	104	1000	2000	400	4 1/8	2200	4400	14.1	
RC73235	Genoa car, S45 BB Core Block™, suits 12mm (1/2") sheet, lock up/down plunger stop	104	700	1400	270	4 1/8	1540	3090	9.5	
RC73243	Slide, spinnaker pole ring, plunger stop	102	-	-	315	4	-	-	11.1	
RC73280	Track end, plastic	32	-	-	35	1 1/4	-	-	1.2	
Track – Supplied with RC7320-INS nylon track bolt insulators										
RC7320-1.0 ¹	Track, black	996	-	-	670	39 3/16	-	-	23.6	
RC7320-1.5 ¹	Track, black	1496	-	-	1000	58 7/8	-	-	35.3	
RC7320-2.0 ¹	Track, black	1996	-	-	1330	78 9/16	-	-	46.9	
RC7320-3.0 ¹	Track, black	2996	-	-	2000	117 15/16	-	-	70.5	

¹ Silver track available - Order as RCxxxxxxS.
² Load ratings based on pull perpendicular to track



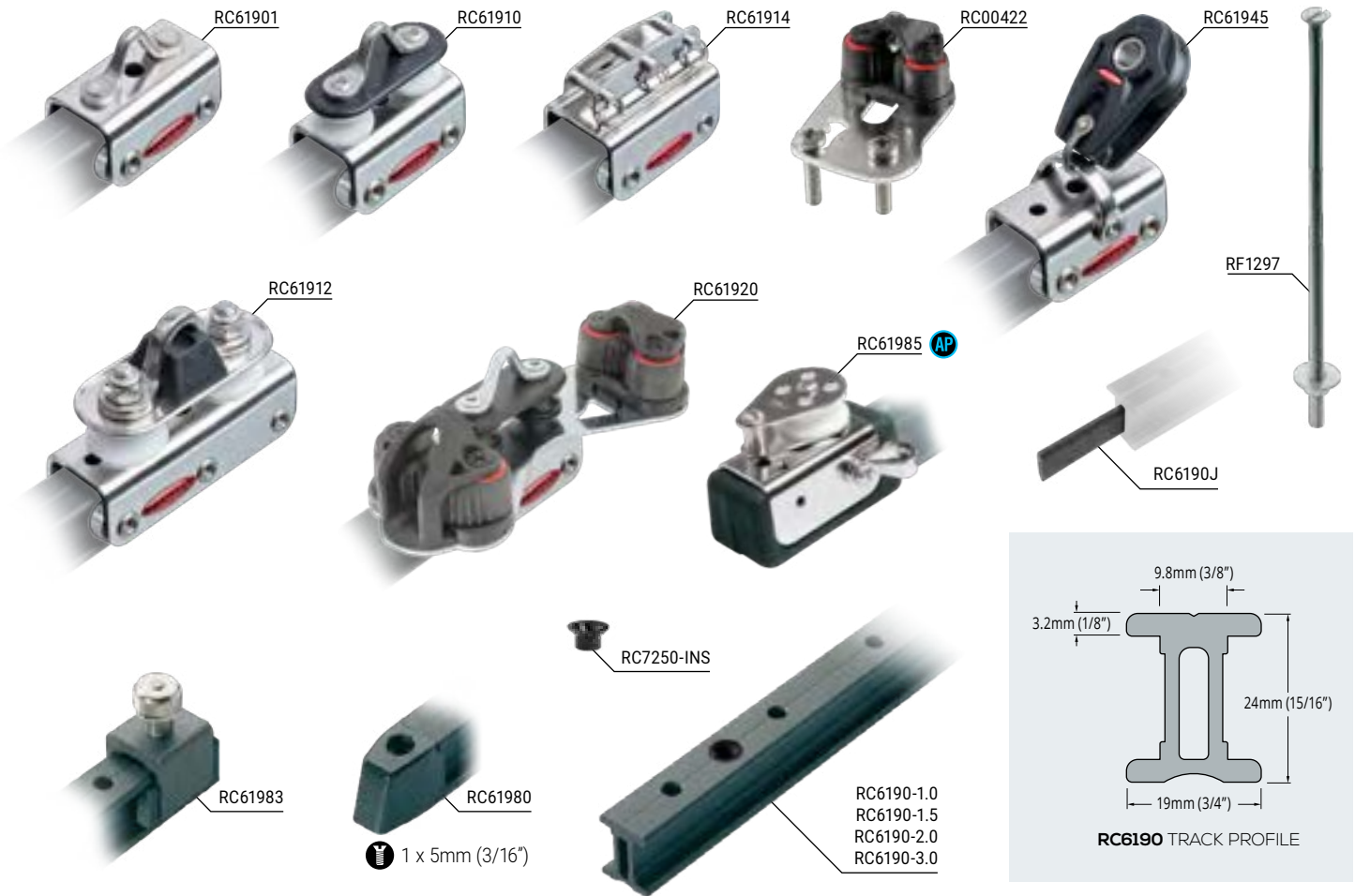

- ✔ Strong stainless steel bodies.
- ✔ Flared sides and angled ball bearing wheels provide high load capacity and smooth operation.
- ✔ Cleat plates can be fitted to suit vertical or horizontal pull of control line.

- ✔ Control sheaves suit up to 6mm (1/4") rope.
- ✔ Refer to page 131 for track bending.
- ⚙ Single cars – Mainsheet and self-tacking jib travellers on dinghies and catamarans.
- ⚙ Tandem cars – Mainsheet systems on boats up to 9m (30ft).

- ⚙ Grade 316 stainless steel car bodies and fixtures.
- ⚙ Grade 2250 stainless steel wheels and bearing races for improved dynamic performance.
- ⚙ UV stabilised acetal control sheaves.
- ⚙ Grade AL6061-T6 aluminium alloy track.

TRACK FASTENINGS – M5 (3/16") countersunk fasteners at 100mm (3 15/16") centres. **STOP HOLES** – 50mm (1 31/32") centres

PRODUCT No.	DESCRIPTION	LENGTH mm	M.W.L. kg	B.L. kg	WEIGHT g	LENGTH in	M.W.L. lb	B.L. lb	WEIGHT oz
Series 19 I-Track									
RC61901	Car, saddle top	51	250	650	115	2	550	1430	4.1
RC61910	Car, saddle top, single control sheaves	51	250	650	125	2	550	1430	4.4
RC61912	Car, saddle top, single control sheaves	86	325	1400	260	3 3/8	715	3080	9.2
RC61914	Car, channel top	51	250	650	140	2	550	1430	4.9
RC61920	Car, saddle top, single control sheaves, cleats	51	250	650	210	2	550	1430	7.4
RC61945	Car, Series 30 Nylatron® sheave Orbit Block™	51	250	500	144	2	550	1100	5.1
RC61980	End cap, plastic	25	-	-	10	1	-	-	0.4
RC61983	Adjustable stop	25	-	-	40	1	-	-	1.4
RC61985	Control end, 28mm (1 1/8") diameter, single AP sheave, becket	70	-	-	130	2 3/4	-	-	4.6
RC7250-INS	Track bolt insulator	-	-	-	3	-	-	-	0.1
RF1297	Track bolt, 3/16" UNC x 152mm (6"), nut, washer	-	-	-	25	-	-	-	0.9
RC00422	Control end cleat addition kit	-	-	-	110	-	-	-	3.9

Track – Supplied with RC7250-INS nylon track bolt insulators

RC6190-1.0	Track, black	996	-	-	830	39 3/16	-	-	29.3
RC6190-1.5	Track, black	1496	-	-	1240	58 7/8	-	-	43.8
RC6190-2.0	Track, black	1996	-	-	1650	78 9/16	-	-	58.3
RC6190-3.0	Track, black	2996	-	-	2480	117 15/16	-	-	87.6
RC6190J	Track joiner	60	-	-	5	2 3/8	-	-	0.2

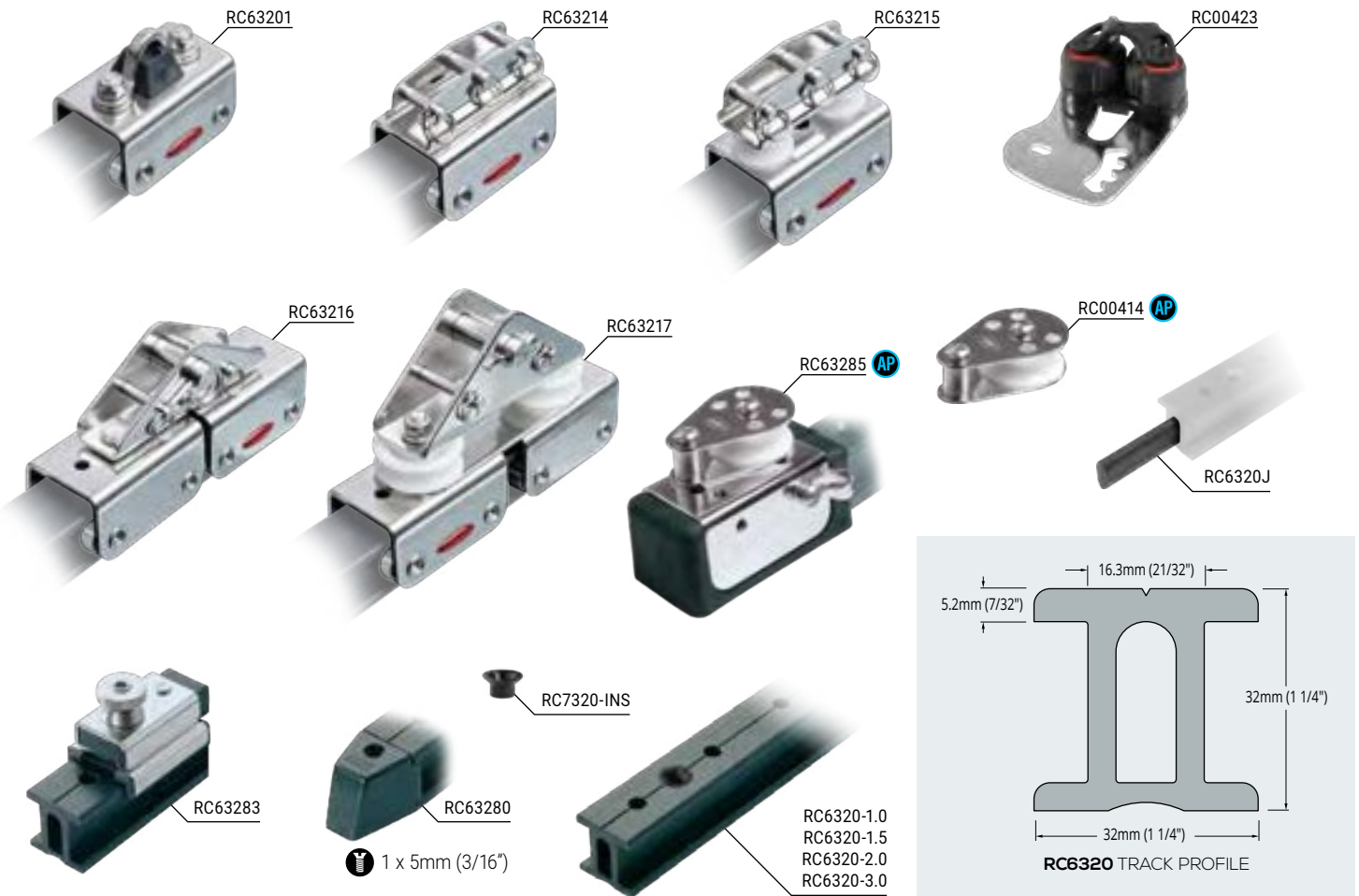

- ✔ Strong stainless steel bodies.
- ✔ Flared sides and angled ball bearing wheels provide high load capacity and smooth operation.
- ✔ Modular track end fittings can be assembled to provide up to 4:1 purchase.
- ✔ Cleat plates can be fitted to suit vertical or horizontal pull of control line.

- ✔ Refer to page 131 for track bending.
- ✔ Control sheaves suit up to 8mm (5/16") rope.
- ⚙ Single cars – Mainsheet and self-tacking jib travellers on boats up to 9m (30ft).
- ⚙ Tandem cars – Mainsheet systems on boats up to 12m (40ft).

- ⚙ Grade 316 stainless steel car bodies, wheels and bearing races and fixtures.
- ⚙ UV stabilised acetal control sheaves.
- ⚙ Grade AL6061-T6 aluminium alloy track.

TRACK FASTENINGS – M6 (1/4") countersunk fasteners at 100mm (3 15/16") centres. **STOP HOLES** – 50mm (2") centres

PRODUCT No.	DESCRIPTION	LENGTH mm	M.W.L. kg	B.L. kg	WEIGHT g	LENGTH in	M.W.L. lb	B.L. lb	WEIGHT oz
Series 32 I-Track									
RC00414	Control end sheave addition kit	-	-	-	70	-	-	-	2.5
RC00423	Control end cleat addition kit	-	-	-	140	-	-	-	4.9
RC7320-INS	Track bolt insulator	-	-	-	3	-	-	-	0.1
RC63201	Car, saddle top, rubber stand-up pad	76	650	2000	320	3	1430	4400	11.3
RC63214	Car, channel top	76	650	1400	370	3	1430	3080	13.1
RC63215	Car, channel top, single control sheaves	76	650	1400	390	3	1430	3080	13.8
RC63216	Car, tandem, channel top	157	1300	4200	735	6 3/16	2860	9240	26.0
RC63217	Car, tandem, channel top, single control sheaves	157	1300	4200	950	6 3/16	2860	9240	33.6
RC63280	End cap, plastic	40	-	-	10	1 9/16	-	-	0.4
RC63283	Adjustable stop	64	-	-	180	2 1/2	-	-	6.3
RC63285	Control end, 38mm (1 1/2") diameter, single AP sheave, becket	98	-	-	330	3 7/8	-	-	11.6
Track - Supplied with RC7320-INS nylon track bolt insulators									
RC6320-1.0	Track, black	996	-	-	1210	39 3/16	-	-	42.8
RC6320-1.5	Track, black	1496	-	-	1810	58 7/8	-	-	64.0
RC6320-2.0	Track, black	1996	-	-	2410	78 9/16	-	-	85.2
RC6320-3.0	Track, black	2996	-	-	3620	117 15/16	-	-	127.9
RC6320J	Track joiner	60	-	-	14	2 3/8	-	-	0.5



Ball Bearing cars



Sliderod cars



Plunger stop can be locked up



Track profile options



Control line accessories



Adjustable control end cleats



BALL BEARING TRAVELLER SYSTEMS

SMOOTH CONTROL

Ronstan traveller systems deliver the performance required for optimising sail trim, responding quickly to changing conditions and getting the right balance from the loads on sails, rig and foils. Ronstan systems have been put to the test by Round the World Race teams, Vendée Globe challengers, and the professionals on the prestige international circuits who demand the highest performance and dependability, with no room for compromise.

BB Ball Bearing cars

Machined alloy car bodies provide high strength and durability with minimum weight. Low profile cars ensure that sheets and control lines run close to the deck. Highly efficient recirculating Toloron® ball bearing systems allow precision adjustment and control even in the most demanding conditions.

SR Sliderod cars

Sliderod cars are suitable for static load applications where adjustment under load is not required and are machined from a dedicated alloy body profile.

Attention to detail

Car bodies are machined to precise specifications, then honed to an exceptional finish before being treated and anodised for maximum corrosion protection. Stainless steel elements are put through a special high energy finishing process to achieve a uniquely smooth edge and surface finish. Spring-loaded plunger stops engage with stop holes in tracks and can be locked in the "up" (disengaged) position.

Control accessories

Cam cleat supports can be adjusted to the optimum cleating angle. Control sheaves provide purchase systems for mainsheet travellers and genoa sheet lead adjustment. Ball Bearing sheave and becket addition kits are available for cars and track control ends to provide extra control line purchase where required.

Tracks

7 track sizes are available in the standard product range, to match system specifications to individual requirements. Beam track options are available for unsupported spans (cockpit, companionway, hatch, etc.). Curved track can be supplied with bend in either horizontal or vertical plane. Minimum bend radius depends on car length. See pages 130 & 131 for options and details.

Custom Solutions

Custom solutions are also available - see the custom products section on www.ronstan.com for ideas and inspiration.

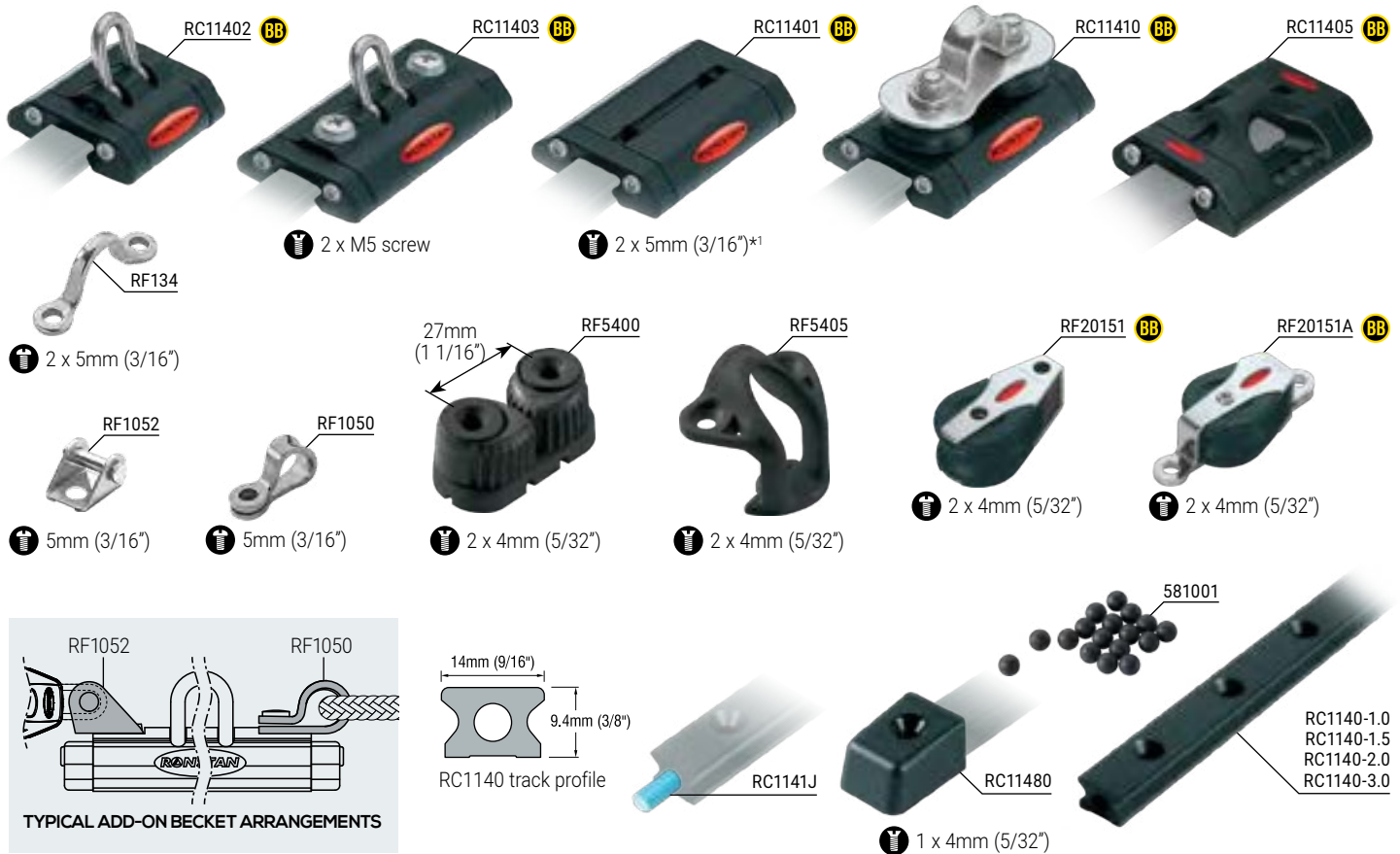

- ✔ Low profile, lightweight alloy cars and impact modified, fibre reinforced and UV stabilised nylon end caps.
- ✔ Twin rows of recirculating acetal ball bearings provide smooth, low friction performance under load.
- ✔ Control sheaves suit up to 6mm (1/4) diam. rope.

- ✔ Loop and fork style fittings are easily added for becket and control line block attachment.
- ✔ Cleats, fairleads and cheek blocks can be mounted directly on deck or cockpit sides to complete the control line systems.
- ✔ Refer to page 131 for track bending.

- ✔ Dinghy and catamaran traveller and jib sheet systems.
- ✔ Alloy track and cars.
- ✔ Acetal ball bearings.
- ✔ Grade 316 stainless steel fixtures.

TRACK FASTENINGS – 4mm (5/32") countersunk fasteners at 50mm (1 31/32") centres

PRODUCT No.	DESCRIPTION	LENGTH	WIDTH	M.W.L.	B.L.	WEIGHT	LENGTH	WIDTH	M.W.L.	B.L.	WEIGHT
		mm	mm	kg	kg	g	in	in	lb	lb	oz
BB Ball Bearing											
RC1141J	Track joiner	40	-	-	-	1	1 9/16	-	-	-	0.1
RC11401*1	Car, 2 mounting holes, 35mm (1 3/8") hole spacing	68	41	150	400	48	2 11/16	1 5/8	330	880	1.7
RC11402	Car, pivoting shackle top	47	41	125	400	45	1 7/8	1 5/8	280	880	1.6
RC11403	Car, pivoting shackle top, 2 mounting screws	78	41	180	400	88	3 1/16	1 5/8	400	880	3.1
RC11405	Orbit Car, integrated lashing eye	50	41	125	250	30	2	1 5/8	275	550	1.1
RC1140-1.0*2	Track, black	996	14	-	-	230	39 3/16	9/16	-	-	8.1
RC1140-1.5*2	Track, black	1496	14	-	-	345	58 7/8	9/16	-	-	12.2
RC1140-2.0*2	Track, black	1996	14	-	-	460	78 9/16	9/16	-	-	16.2
RC1140-3.0*2&3	Track, black	2996	14	-	-	690	117 15/16	9/16	-	-	24.3
RC11410	Car, saddle top, single AP control sheaves	68	41	150	400	86	2 11/16	1 5/8	330	880	3.0
RC11480	End cap, plastic	28	20	-	-	6	1 1/8	25/32	-	-	0.2
Accessories											
581001	Ball bearing, acetal, 5.00mm (0.197") diameter	-	-	-	-	1	-	-	-	-	0.1
RF134	Saddle, control line termination point	-	-	-	-	5	-	-	-	-	0.2
RF1050	Control becket, 8mm (5/16") eye, suits RC11403	-	-	-	-	6	-	-	-	-	0.2
RF1052	Control becket fork, 5mm (3/16") pin, suits RC11403	-	11	-	-	9	-	7/16	-	-	0.3
RF5400	Cleat, suits 2mm - 8mm (3/32" - 5/16") rope	-	-	75	150	20	-	-	165	330	0.7
RF5405	Fairlead, suits RF5400 C-Cleat™	-	-	-	-	7	-	-	-	-	0.2
RF20151	20mm (3/4") BB Utility cheek block, for leading control lines	-	-	250	550	14	-	-	550	1210	0.5
RF20151A	20mm (3/4") BB Utility cheek block, rivet mount, for leading control lines	-	-	200	550	17	-	-	440	1210	0.6

*1 RC11401 holes are countersunk on underside of car.
 *2 Silver track available - order as RCxxxxxS
 *3 Longer tracks available on request.



2 x M5 screw

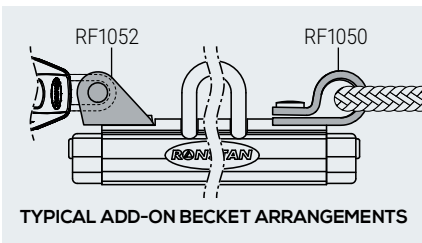

- ✔ Low profile, lightweight alloy cars and impact modified, fibre reinforced and UV stabilised nylon end caps.
- ✔ Twin rows of recirculating Torlon® ball bearings provide smooth, low friction performance under load.
- ✔ Compact sheave arrangements for neat, low profile control line purchase systems. Control sheaves are 24mm (15/16) diameter and suit up to 6mm (1/4) rope.
- ✔ Loop and fork style fittings are easily added for becket and control line block attachment.
- ⚙ Dinghy and catamaran mainsheet traveller and jib lead sheeting systems.

PRODUCT No.	DESCRIPTION	LENGTH	WIDTH	M.W.L.	B.L.	WEIGHT	LENGTH	WIDTH	M.W.L.	B.L.	WEIGHT
		mm	mm	kg	kg	g	in	in	lb	lb	oz
BB RC11902	Car, pivoting shackle top	50	47	300	1050	60	2	1 7/8	660	2310	2.1
RC11903	Car, pivoting shackle top, 2 mounting screws	70	47	400	1490	85	2 3/4	1 7/8	880	3280	3.0
RC11905	Orbit Car, integrated lashing eye	50	47	300	600	38	2	1 7/8	660	1320	1.3
RC11910	Car, saddle top, single AP control sheaves	85	47	500	1240	120	3 11/32	1 7/8	1100	2730	4.2
RC11920	Car, saddle top, single AP control sheaves, C-Cleats™	85	47	500	1240	325	3 11/32	1 7/8	1100	2730	11.5
RC11921	Car, saddle top, double AP control sheaves, C-Cleats™	85	47	500	1240	345	3 11/32	1 7/8	1100	2730	12.2
RC11945	Car, 20mm (3/4) BB Utility block	50	47	250	550	60	2	1 7/8	550	1210	2.1

Accessories

501002	Ball bearing, Torlon®, 5.00mm (0.197) diameter	-	-	-	-	1	-	-	-	-	0.1
RF1050	Control becket, 8mm (5/16) eye, suits RC11903	-	-	-	-	6	-	-	-	-	0.2
RF1052	Control becket fork, 5mm (3/16) pin, suits RC11903	-	11	-	-	9	-	7/16	-	-	0.3



- ✔ Low profile, lightweight alloy cars and impact modified, fibre reinforced and UV stabilised nylon end caps.
- ✔ Twin rows of recirculating Torton® ball bearings allow smooth adjustment of sheet lead position under load.
- ✔ Genoa cars pivot to 45° from vertical for optimum alignment with sheet load.
- ✔ Genoa car sheaves are 40mm (1 9/16") diameter,

and wide enough to accept two sheets for easy headsail changes.

- ✔ The sliderod car is a simple option for a sheet lead that does not require adjustment under load, and has a plunger stop for precise and repeatable positioning.
- ✔ Control sheaves are 31mm (1 1/4") and suit up to 6mm (1/4") rope.
- ✔ Adjustable stops can be fitted on track aft of genoa cars and used to relieve load on adjustment tackle.

- ⬆ Mainsheet traveller and jib lead sheeting systems on sportsboats and keelboats to 7m (23ft).
- ⚙ Alloy track, cars and control ends.
- ⚙ Torton® ball bearings.
- ⚙ Acetal sliderods.
- ⚙ Acetal primary sheaves (genoa cars).
- ⚙ Grade 316 stainless steel fixtures.

PRODUCT No.	DESCRIPTION	LENGTH	WIDTH	M.W.L.	B.L.	WEIGHT	LENGTH	WIDTH	M.W.L.	B.L.	WEIGHT
		mm	mm	kg	kg	g	in	in	lb	lb	oz
BB Ball Bearing											
RC11912	Car, pivoting saddle top, single control sheaves	100	47	605	1670	215	3 15/16	1 7/8	1330	3680	7.6
RC11922	Car, pivoting saddle top, single control sheaves & cleat	100	47	605	1670	365	3 15/16	1 7/8	1330	3680	12.9
RC11930	Genoa car, control beackets	100	47	605	1430	245	3 15/16	1 7/8	1330	3150	8.6

SR Sliderod											
RC00451	Sliderods, suits RC51930 (pair)	72	5	-	-	6	2 13/16	3/16	-	-	0.2
RC00452	Sliderods, suits RC11983 (pair)	45	5	-	-	4	1 3/4	3/16	-	-	0.1
RC00453	Sliderods, suits RC51940 (pair)	37	5	-	-	3	1 7/16	3/16	-	-	0.1
RC51930	Genoa car, sliderods, plunger stop	82	39	660	1430	230	3 1/4	1 9/16	1460	3150	8.1
RC51940	Car, sliderods, pivoting shackle plunger stop	55	39	310	1050	95	2 3/16	1 9/16	680	2310	3.6

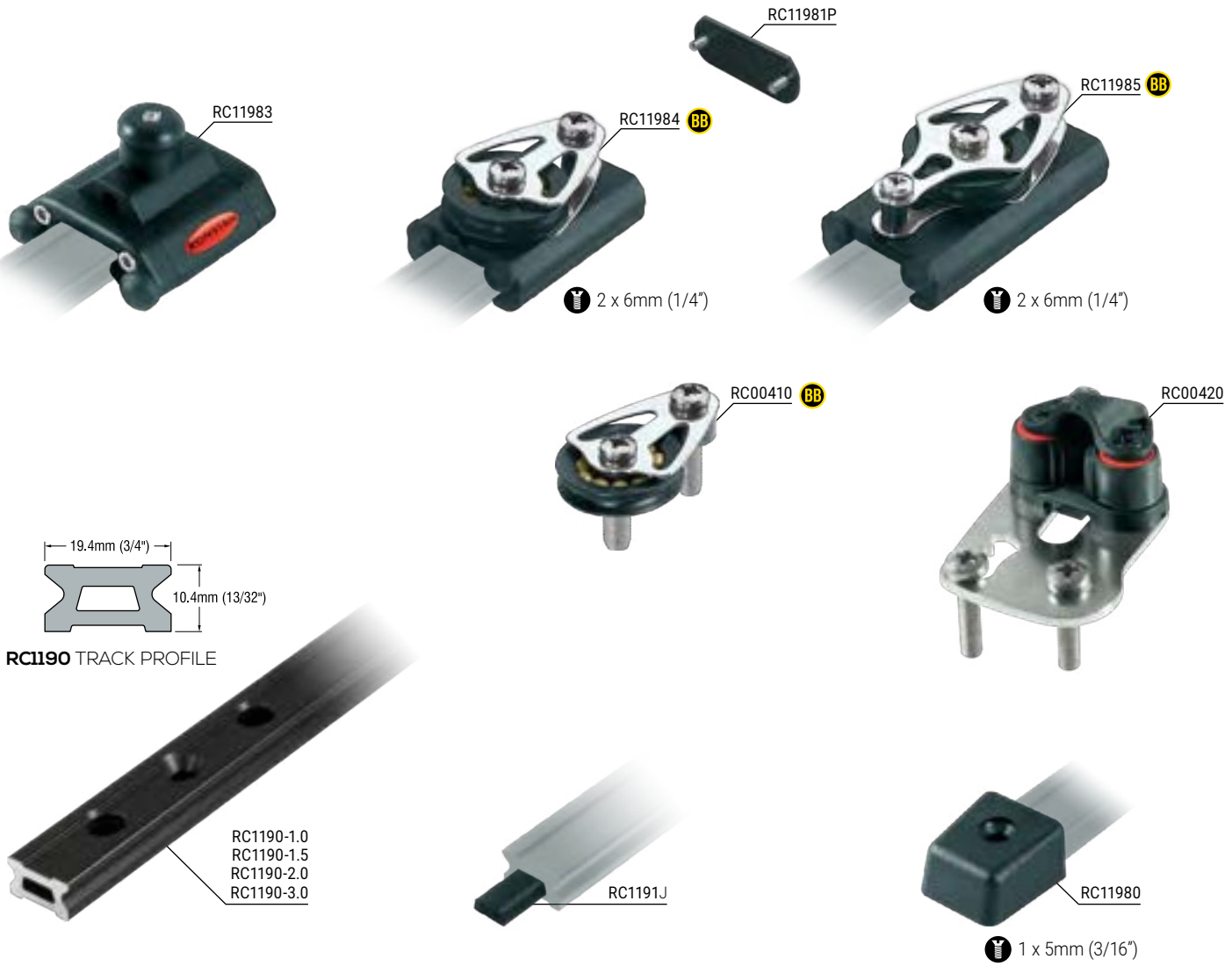

TRACK FASTENINGS – 5mm (3/16”) countersunk fasteners at 100mm (3 15/16”) centres **STOP HOLES** – 50mm (1 31/32”) centres

- ✔ Control ends with high performance Torlon® ball bearing sheaves are used with mainsheet traveller and genoa sheeting systems to create purchase systems for easy adjustment of car position under load.
- ✔ Control end sheaves are 30mm (1 3/16”) diameter and suit up to 6mm (1/4”) rope.
- ✔ Track has stop holes for cars fitted with plunger stops.
- ✔ Cleat kits include mounting screws and are easily fitted to control ends – supports can be adjusted to optimum cleating angle.
- ✔ Refer to page 131 for track bending.
- ⬆ Mainsheet systems on boats to 7m (23ft).
- ⬆ Genoa sheet systems on boats to 10m (33ft).
- ⚙ Alloy track, cars and control ends.
- ⚙ Grade 316 stainless steel fixtures.

PRODUCT No.	DESCRIPTION	LENGTH	WIDTH	M.W.L.	B.L.	WEIGHT	LENGTH	WIDTH	M.W.L.	B.L.	WEIGHT
		mm	mm	kg	kg	g	in	in	lb	lb	oz
BB RC00410	BB control end sheave addition kit	39	30	165	675	33	1 9/16	1 3/16	360	1490	1.2
RC00420	Control end C-Cleat™ addition kit	-	-	-	-	94	-	-	-	-	3.3
RC1190-1.0*1	Track, black	996	19	-	-	310	39 3/16	3/4	-	-	10.9
RC1190-1.5*1	Track, black	1496	19	-	-	465	58 7/8	3/4	-	-	16.4
RC1190-2.0*1	Track, black	1996	19	-	-	620	78 9/16	3/4	-	-	21.9
RC1190-3.0*1&2	Track, black	2996	19	-	-	930	117 15/16	3/4	-	-	32.8
RC1191J	Track joiner	60	-	-	-	3	2 3/8	-	-	-	0.1
RC11980	End cap, plastic	30	26	-	-	6	1 3/16	1	-	-	0.2
RC11981P	Cover plate for control end, includes screws	-	39	-	-	3	-	1 9/16	-	-	0.1
RC11983	Adjustable stop	57	47	-	-	65	2 1/4	1 7/8	-	-	2.3
RC11984	Control end, single BB sheave	65	39	165	675	82	2 9/16	1 9/16	360	1490	2.9
RC11985	Control end, single BB sheave & becket	78	39	245	675	102	3 1/16	1 9/16	540	1490	3.6

*1 Silver track available - Order as RCxxxxxxS
 *2 Longer track available on request.

ORBIT

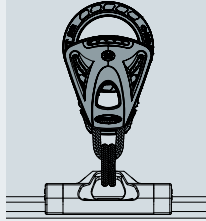

Orbit Block™ in line with car using additional Dyneema® link

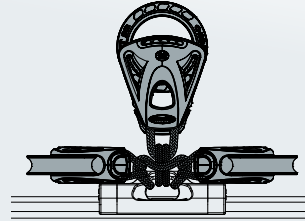

Orbit Block™ in line with car using additional Dyneema® link. Control blocks linked to each other through additional Dyneema® link.

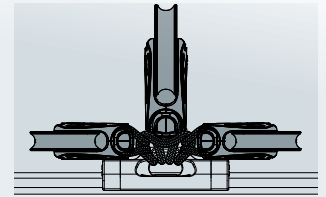

Orbit Block™ 90° to car using supplied Dyneema® link. Control blocks attached using additional Dyneema® link.



2 x M6 screw



6mm (1/4")

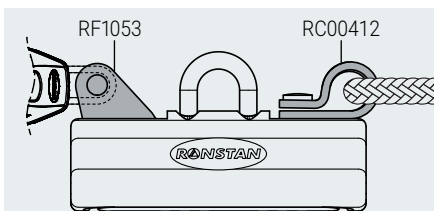
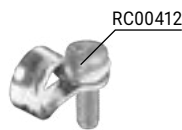

TYPICAL ADD-ON BECKET ARRANGEMENTS

- ✓ Low profile, lightweight alloy cars.
- ✓ Loop and fork style fittings are easily added for becket and control line block attachment.
- ✓ Compact sheave arrangements for neat, low profile control line purchase systems. Control sheaves are 30mm (1 3/16") diameter and suit up to 6mm (1/4") rope.
- ✓ Twin rows of recirculating Torlon® ball bearings provide smooth, low friction performance for easy adjustment under load.

PRODUCT No.	DESCRIPTION	LENGTH	WIDTH	M.W.L.	B.L.	WEIGHT	LENGTH	WIDTH	M.W.L.	B.L.	WEIGHT
		mm	mm	kg	kg	g	in	in	lb	lb	oz
BB Ball Bearing											
RC12203	Car, pivoting shackle top, 2 mounting screws	75	58	500	1490	145	3	2 5/16	1100	3280	5.1
RC12205	Orbit Car, integrated lashing eye	75	58	500	1490	110	3	2 5/16	1100	3280	3.9
RC12210	Car, saddle top, single control sheaves	125	58	880	2180	250	5	2 5/16	1940	4810	8.8
RC12220	Car, saddle top, single AP control sheaves, C-Cleats™	125	58	880	2000	635	5	2 5/16	1940	4410	22.4
RC12221	Car, saddle top, double AP control sheaves, C-Cleats™	125	58	880	2000	655	5	2 5/16	1940	4410	23.1
Accessories											
RC00412	Control becket, 8mm (5/16") eye, M6 screws, suits RC12203, RC12204 & RC12231	-	-	-	-	6	-	-	-	-	0.2
RF1053	Control becket fork, 5mm (3/16") pin, suits RC12203 & RC12204	-	14	-	-	9	-	9/16	-	-	0.3



WINDWARD CONTROL CAR OPERATION

- 1 Windward control line is pulled in.
- 2 Cleat 'bridge' slides to windward on car.
- 3 Leeward cleat cams are opened by two pins fixed to car, releasing the leeward control line automatically.
- 4 Windward control line released, cleat bridge at rest with both control lines recleated.

- ✔ RC12223 cleat supports can be adjusted to optimum cleating angle.
- ✔ RC12227 windward control car control line sheaves suit 4:1 or 5:1 purchase system.
- ✔ RF44000 suits cars RC12213 & RC12223 for upgrade to ball bearing sheave.

- ✔ Stand-up spring kit RF324-1 is available to suit mainsheet cars RC12213, RC12223. Combine with a mainsheet system RF72700 or RF72900 for ultimate mainsheet control.
- ⚠ Mainsheet systems on boats to 10m (33ft).

- ⚙ Alloy track, cars and control ends.
- ⚙ Torlon® ball bearings in cars.
- ⚙ Acetal control sheaves.
- ⚙ Grade 316 stainless steel fixtures.

PRODUCT No.	DESCRIPTION	LENGTH mm	WIDTH mm	M.W.L. kg	B.L. kg	WEIGHT g	LENGTH in	WIDTH in	M.W.L. lb	B.L. lb	WEIGHT oz
BB Ball Bearing											
RC12204	Car, pivoting shackle top, 2 mounting screws	125	58	880	2640	230	5	2 5/16	1940	5820	8.1
RC12213	Car, pivoting shackle top, double control sheaves	180	58	880	2180	520	7 1/16	2 5/16	1940	4810	18.3
RC12223	Car, pivoting shackle top, double control sheaves, adjustable C-Cleats™	180	58	880	2180	930	7 1/16	2 5/16	1940	4810	32.8
RC12227	Windward control car, pivoting top, triple control sheaves & C-Cleats™	175	58	880	2180	1056	6 7/8	2 5/16	1940	4810	37.2
Accessories											
RF324-1	Stand-up spring kit, suits RC12213, RC12223	-	-	-	-	60	-	-	-	-	2.1
RF44000	Aluminium control sheave, 40mm (1 1/2") diameter	-	-	-	-	16	-	-	-	-	0.6



© Jurka Mihelin



- ✔ Ball bearing cars have twin rows of recirculating Torlon® ball bearings for smooth adjustment under load.
- ✔ RC52230 sliderod genoa car is a simple option for a sheet lead that does not require adjustment under load. Plunger stop can be locked in the "up" position.
- ✔ Control sheaves are 40mm (1 1/2") diameter and suit up to 6mm (1/4") rope.
- ✔ Genoa car sheaves are 60mm (2 3/8") diameter, and wide enough to accept two sheets for easy headsail changes.
- ✔ Alloy roller ball bearing sheave upgrade suits genoa cars with 60mm (2 3/8") sheaves.
- ✔ Extra purchase for lead adjustment systems can easily be added by fitting becket or block addition kits (supplied with mounting screws).
- ✔ Genoa sheet systems on boats to 11m (36ft).
- ✔ Alloy track, cars and control ends.
- ✔ Torlon® ball bearings in cars.
- ✔ Acetal primary sheaves (genoa cars) and control sheaves.
- ✔ Alloy ball bearing sheave upgrade available.
- ✔ Grade 316 stainless steel fixtures.

PRODUCT No.	DESCRIPTION	LENGTH mm	WIDTH mm	M.W.L. kg	B.L. kg	WEIGHT g	LENGTH in	WIDTH in	M.W.L. lb	B.L. lb	WEIGHT oz
BB Ball Bearing											
RC12231	Genoa car, single control sheave	165	58	990	2300	570	6 1/2	2 5/16	2180	5070	20.1
RF68000W	Aluminium roller bearing upgrade sheave, 60mm (2 3/8") diameter, suits RC12231, RC52230	-	32	1150	-	128	-	1 1/4	2540	-	4.5
SR Sliderod											
RC52230	Genoa car, sliderods, plunger stop	125	45	1205	2410	520	5	1 3/4	2660	5310	18.3
Accessories											
501001	Ball bearing, Torlon®, 6.35mm (1/4") diameter	-	-	-	-	1	-	-	-	-	0.1
RC00411	Control sheave addition kit, includes 2 x M6 screws, suits RC12231	65	40	240	900	47	2 9/16	1 9/16	530	1980	1.7
RC00412	Control becket, 8mm (5/16") eye, M6 screw, suits RC12231	-	-	-	-	6	-	-	-	-	0.2

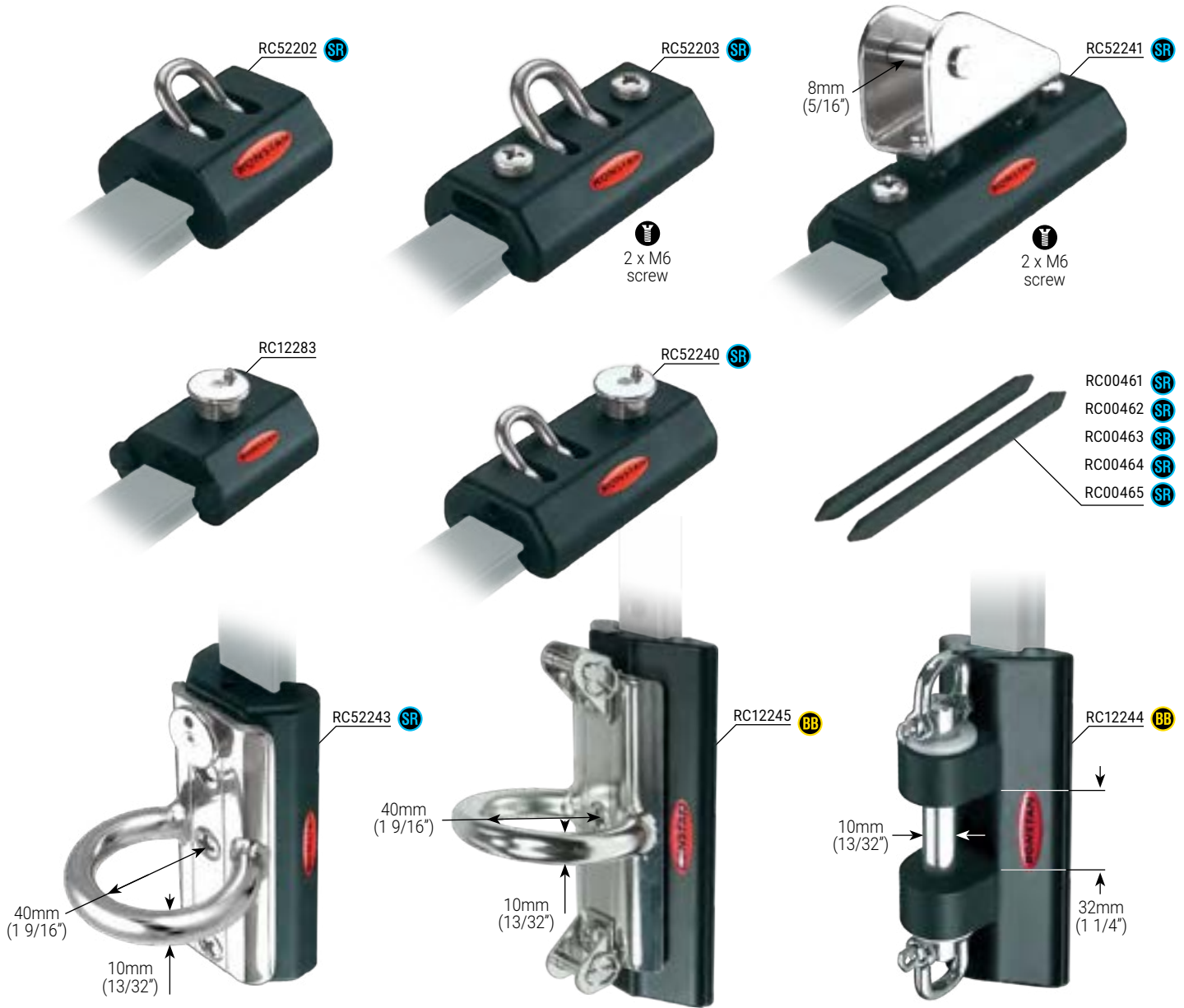

- ✔ Sliderod cars with pivoting shackles suit a variety of applications where a secure, adjustable take-off point for a block or control line is required. Plunger stops can be locked in the "up" position.
- ✔ Sliderod spinnaker pole car suits poles set up for end-for-end gybes. Adjustment is by plunger stop.
- ✔ Adjustable stops can be fitted on track aft of genoa cars and used to relieve load on adjustment tackle.
- ✔ RC12244 spinnaker pole car suits piston style inboard end fittings with 32mm (1 1/4") toggle.
- ⬆ Spinnaker pole systems on boats to 10m (33ft).
- ⬆ Outhaul car for boats to 8m (26ft).

PRODUCT No.	DESCRIPTION	LENGTH	WIDTH	M.W.L.	B.L.	WEIGHT	LENGTH	WIDTH	M.W.L.	B.L.	WEIGHT
		mm	mm	kg	kg	g	in	in	lb	lb	oz
BB Ball Bearing											
RC12244	Spinnaker pole car, suits 32mm (1 1/4") toggle, towing eyes	130	58.0	1350	2700	308	5 1/8	2 5/16	2980	5950	10.9
RC12245	Spinnaker pole car, ring, towing forks	118	58.0	800	1600	405	4 5/8	4 5/8	1760	3530	14.3
SR Sliderod											
RC00461	Sliderods, suits RC52202 (pair)	37	6.4	-	-	4	1 7/16	1/4	-	-	0.1
RC00462	Sliderods, suits RC52203, RC52240 (pair)	74	6.4	-	-	8	2 15/16	1/4	-	-	0.3
RC00463	Sliderods, suits RC52241 (pair)	104	6.4	-	-	11	4 1/8	1/4	-	-	0.4
RC00464	Sliderods, suits RC52243 (pair)	94	6.4	-	-	10	3 11/16	1/4	-	-	0.4
RC00465	Sliderods, suits RC52230 (pair)	114	6.4	-	-	12	4 1/2	1/4	-	-	0.4
RC12283	Adjustable stop	60	45	-	-	104	2 3/8	1 3/4	-	-	3.7
RC52202	Car, sliderods, pivoting shackle	48	45.0	600	1490	95	1 7/8	1 3/4	1320	3280	3.4
RC52203	Car, sliderods, pivoting shackle, internal control beackets	85	45.0	1000	2690	166	3 3/8	1 3/4	2200	5930	5.9
RC52240	Car, sliderods, pivoting shackle & plunger stop	85	45.0	975	1940	177	3 3/8	1 3/4	2150	4280	6.2
RC52241	Outhaul car, sliderods, 8mm (5/16") pin, internal control beackets	115	45.0	1205	2410	347	4 1/2	1 3/4	2660	5310	12.2
RC52243	Spinnaker pole car, sliderods, ring, plunger stop	105	45.0	1300	2500	410	4 1/8	1 3/4	2870	5510	14.5

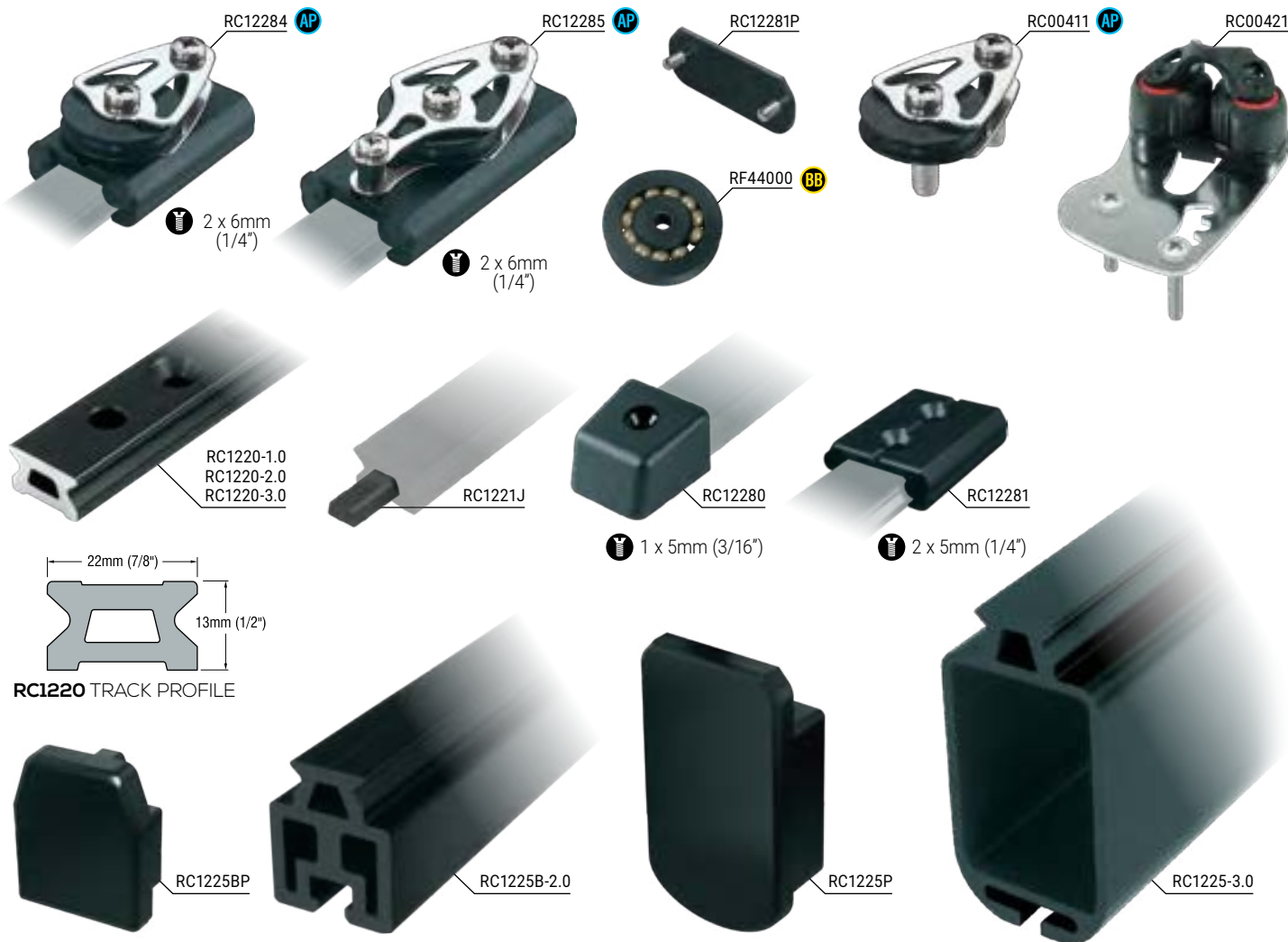

TRACK FASTENINGS – 6mm (1/4”) countersunk fasteners at 100mm (3 15/16”) centres **STOP HOLES** – 50mm (1 31/32”) centres (RC1220 only)

- ✔ Control ends are used with mainsheet traveller and genoa sheeting systems to create purchase systems for easy adjustment of car position under load.
- ✔ Cleat kits include mounting screws and are easily fitted to control ends – supports can be adjusted to optimum cleating angle.
- ✔ Beam tracks can be used for unsupported spans to bridge cockpits and companionway hatches. They are supplied without fastener or stop holes. See page 130 for mechanical data.
- ✔ 40mm (1 9/16”) diameter control end sheaves suit up to 6mm (1/4”) rope.
- ✔ Control ends can be fitted with RC12281P to conceal track end.
- ✔ Standard low profile track has stop holes for cars fitted with plunger stops.
- ✔ Refer to page 131 for track bending.
- ✔ Mainsheet systems on boats to 10m (33ft).
- ✔ Genoa sheet systems on boats to 11m (36ft).
- ✔ RC1225-3.0: Grade AL6063-T6 aluminium alloy.

PRODUCT No.	DESCRIPTION	LENGTH mm	WIDTH mm	M.W.L. kg	B.L. kg	WEIGHT g	LENGTH in	WIDTH in	M.W.L. lb	B.L. lb	WEIGHT oz
Accessories											
RC00411	Control sheave addition kit, suits RC12284, RC12285	65	40	240	900	47	2 9/16	1 9/16	530	1980	1.7
RC00421	Control end C-Cleat™ addition kit, suits RC12284, RC12285	-	-	-	-	207	-	-	-	-	7.3
RC1220-1.0*1	Track, black	996	22	-	-	460	39 3/16	7/8	-	-	16.2
RC1220-2.0*1	Track, black	1996	22	-	-	920	78 9/16	7/8	-	-	32.5
RC1220-3.0*1&2	Track, black	2996	22	-	-	1380	117 15/16	7/8	-	-	48.7
RC1221J	Track joiner	60	-	-	-	4	2 3/8	-	-	-	0.1
RC1225-3.0*1	Beam track, black. 45mmW x 85mmH (1 25/32”W x 3 11/32”H)	2996	85	-	-	6240	117 15/16	3 3/8	-	-	220.1
RC1225P	End plug for RC1225 beam track	-	45	-	-	4	-	1 3/4	-	-	0.1
RC1225B-2.0*1	Beam track, black. 37mmW x 44mmH (1 7/16”W x 1 3/4”H)	1996	37	-	-	4530	78 9/16	1 7/16	-	-	160.1
RC1225BP	End plug for RC1225B beam track	-	37	-	-	18	-	1 7/16	-	-	0.6
RC12280	End cap, plastic	30	26	-	-	6	1 3/16	1	-	-	0.2
RC12281*1	Track end stop, aluminium alloy	50	45	-	-	50	1 31/32	1 25/32	-	-	1.8
RC12281P	Cover plate for control end	-	45	-	-	5	-	1 3/4	-	-	0.2
RC12284	Control end, single sheave	83	45	240	900	140	3 9/32	1 3/4	530	1980	4.9
RC12285	Control end, single sheave & becket	103	45	320	900	168	4 1/16	1 3/4	710	1980	5.9
RF44000	Aluminium alloy control sheave, 40mm (1 1/2”) diameter	-	-	-	-	16	-	-	-	-	0.6

*1 Silver track available - Order as RCxxxxxS
 *2 Longer track available on request



© Italia Yachts



- ✔ RC12617 with pivoting sheave unit is a compact and low profile solution for 2:1 mainsheet systems. Suits up to 6:1 control line purchase. Pivoting of the main sheave unit is limited to 4° aft and 45° forward.

- ✔ 50mm (2") diameter control line sheaves suit up to 8mm (5/16") rope.

- ✔ The fully machined RC12605 Orbit Car provides the ultimate in lightweight and flexibility. Blocks may be attached with a Dyneema® link or lashing. Multiple cars can be linked together for higher working load or to suit curved tracks.

- ⬆ Mainsheet systems on boats to 12m (40ft).
- ⬆ Self-tacking jib sheet systems on boats to 10m (33ft).

- ⚙ Alloy track, cars and control ends.
- ⚙ Torlon® ball bearings in cars.
- ⚙ Alloy ball bearing sheave upgrade available (RC12617).
- ⚙ Grade 316 stainless steel fixtures (RC12617).

PRODUCT No.	DESCRIPTION	LENGTH	WIDTH	M.W.L.	B.L.	WEIGHT	LENGTH	WIDTH	M.W.L.	B.L.	WEIGHT
		mm	mm	kg	kg	g	in	in	lb	lb	oz
BB Ball Bearing											
RC12605	Orbit Car, integrated lashing eye	108	69	850	1700	18	4 1/4	2 3/4	1870	3740	0.6
RC12617	Car, 1 x 75mm (3") diameter sheave, triple 50mm (2") diameter control sheaves, C-Cleats™	210	70	1700	3400	2280	8 1/4	2 3/4	3750	7500	80.4
Accessories											
501010	Ball bearing, Torlon®, 8.00mm (5/16") diameter	-	-	-	-	1	-	-	-	-	0.1
RF54000	Aluminium ball bearing control sheave, 50mm (2") diameter, suits RC12613, RC12631, RC12623, RC12617	-	-	-	-	32	-	-	-	-	1.1
RF78000W	Aluminium roller ball bearing sheave, 75mm (3") diameter, suits RC12617	-	-	-	-	280	-	-	-	-	9.9

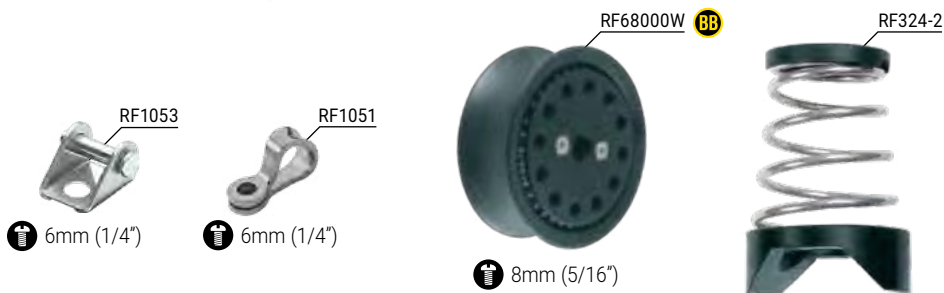
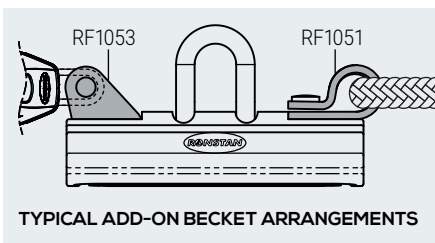

- ✔ Ball bearing cars have twin rows of recirculating Torton® ball bearings for smooth, precise adjustment under load.
- ✔ 40mm (1 9/16") diameter control sheaves suit up to 6mm (1/4") rope.
- ✔ RC12631 genoa car sheave is 60mm (2 3/8") diameter and can accept two sheets for easy headsail changes.
- ✔ Individual cleat supports on mainsheet car can be adjusted to optimum cleating angle.
- ✔ Ball bearing sheaves available for enhanced performance.
- ✔ RF324-2 provides support for Series 60 Orbit Block™ on mainsheet cars RC12603, RC12613, RC12623.
- ✔ Mainsheet systems on boats to 12m (40ft).
- ✔ Genoa sheet systems on boats to 13m (43ft).
- ✔ Self-tacking jib sheet systems on boats to 10m (33ft).
- ✔ Alloy track, cars and control ends.
- ✔ Torton® ball bearings in cars.
- ✔ Acetal sheaves.
- ✔ Grade 316 stainless steel fixtures.

PRODUCT No.	DESCRIPTION	LENGTH	WIDTH	M.W.L.	B.L.	WEIGHT	LENGTH	WIDTH	M.W.L.	B.L.	WEIGHT
		mm	mm	kg	kg	g	in	in	lb	lb	oz
BB Ball Bearing											
RC12603	Car, pivoting shackle, 2 mounting screws	120	69	690	1380	331	4 3/4	2 3/4	1520	3040	11.7
RC12613	Car, pivoting shackle, double control sheaves	200	69	1700	3400	740	7 7/8	2 3/4	3750	7500	26.1
RC12623	Car, pivoting shackle, double control sheaves, adjustable C-Cleats™	205	69	1700	3400	1042	8 1/16	2 3/4	3750	7500	36.8
RC12631	Genoa car, single control sheave	180	69	1400	2800	582	7 1/16	2 3/4	3090	6170	20.5
Accessories											
RF324-2	Stand-up spring kit, suits RC12603, RC12613, RC12623	-	-	-	-	60	-	-	-	-	2.1
RF1051	Control becket, 8mm (5/16") eye, suits RC12603 & RC12631	-	-	-	-	6	-	-	-	-	0.2
RF1053	Control becket fork, 5mm (3/16") pin, suits RC12603 & RC12631	-	14	-	-	9	-	9/16	-	-	0.3
RF68000W	Aluminium roller ball bearing sheave, 60mm (2 3/8") diameter, suits RC12631	-	33	1150	-	128	-	1 1/4	2540	-	4.5



TRACK FASTENINGS – 6mm (1/4") countersunk fasteners at 100mm (3 15/16") centres **STOP HOLES** – 50mm (1 31/32") centres

- ✔ Control ends are used with mainsheet traveller and genoa sheeting systems to create purchase systems for easy adjustment of car position under load.
- ✔ Control ends can be fitted with RC12681P to conceal track end.
- ✔ Refer to page 131 for track bending.
- ✔ Alloy track and end caps.
- ⚙ Torlon® ball bearings in cars.
- ⚙ Acetal sheaves.
- ⚙ Alloy ball bearing sheave upgrade available.
- ⚙ Grade 316 stainless steel fixtures.

PRODUCT No.	DESCRIPTION	LENGTH mm	WIDTH mm	M.W.L. kg	B.L. kg	WEIGHT g	LENGTH in	WIDTH in	M.W.L. lb	B.L. lb	WEIGHT oz
Accessories											
RC1260-1.0*1	Track, black	996	26	-	-	600	39 3/16	1 1/16	-	-	21.2
RC1260-2.0*1	Track, black	1996	26	-	-	1200	78 9/16	1 1/16	-	-	42.3
RC1260-3.0*1&2	Track, black	2996	26	-	-	1800	117 15/16	1 1/16	-	-	63.5
RC1261J	Track joiner	60	-	-	-	5	2 3/8	-	-	-	0.2
RC12680	End cap, plastic	34	32	-	-	7	1 5/16	1 1/4	-	-	0.2
RC12681	End stop, aluminium	55	45	-	-	73	2 5/32	1 25/32	-	-	2.6
RC12681P	Cover plate for control end & track, including screws	-	45	-	-	7	-	1 3/4	-	-	0.2
RC12683	Adjustable stop	55	64	-	-	120	2 5/32	2 3/4	-	-	4.2
RC12685	Control end, single sheave & becket	95	45	320	900	211	3 3/4	1 25/32	710	1980	7.4
RC12686	Control end, double sheaves	95	45	450	900	198	3 3/4	1 25/32	990	1980	7.0
RC12687	Control end, double sheaves & becket	95	45	450	900	258	3 3/4	1 25/32	990	1980	9.1
RC12687C	Control end, double sheaves & becket, C-Cleat™	95	45	450	900	405	3 3/4	1 25/32	990	1980	14.3
RF44000	Aluminium ball bearing control sheave, 40mm (1 1/2") diameter	-	-	-	-	16	-	-	-	-	0.6

*1 Silver track available - Order as RCxxxxxS
 *2 Longer track available on request.





- ✓ RC13017 with pivoting sheave unit is a compact and low profile solution for 2:1 mainsheet systems. Pivoting of the main sheave unit is limited to 4° aft and 45° forward.

- ✓ 50mm (2") diameter control line sheaves suit up to 8mm (5/16") rope.

- ✓ Stand-up spring suits Series 60 & 75 single Orbit Blocks™ and Core Blocks™

- ⚙ Mainsheet systems on boats to 18m (60ft).
- ⚙ Self-tacking jib sheet systems on boats to 11m (36ft).

- ⚙ Alloy track, cars and control ends.
- ⚙ Torlon® ball bearings in cars.
- ⚙ Alloy ball bearing sheave upgrade available.
- ⚙ Grade 316 stainless steel fixtures.

PRODUCT No.	DESCRIPTION	LENGTH	WIDTH	M.W.L.	B.L.	WEIGHT	LENGTH	WIDTH	M.W.L.	B.L.	WEIGHT
		mm	mm	kg	kg	g	in	in	lb	lb	oz
BB RC13005	Orbit Car, integrated lashing eye	120	77	1000	2000	300	4 3/4	3 1/16	2200	4400	10.6
RC13017	Car, 1 x 75mm (3") diameter sheave, triple 50mm (2") diameter control sheaves, C-Cleats™	210	77	1900	3800	2330	8 1/4	3 1/16	4180	8360	82.2
RC13018A	Car, 2 x padeye for main block attachment, double 50mm (2") diameter control sheaves	332	77	2700	5400	1585	13 1/16	3 1/16	5950	11900	55.9

Accessories

RF324	Stand-up spring suits Series 60 & 75 single Orbit Blocks™ and Core Blocks™	-	-	-	-	80	-	-	-	-	2.8
RF54000	Aluminium ball bearing control sheave, 50mm (2") diameter, suits RC12613, RC12631, RC12623, RC13017	-	-	-	-	32	-	-	-	-	1.1
RF78000W	Aluminium roller ball bearing sheave, 75mm (3") diameter, suits RC13017	-	-	-	-	280	-	-	-	-	9.9



- ✓ Low profile, lightweight alloy cars and end caps.
- ✓ RC13023 individual cleat supports can be adjusted to optimum cleating angle.
- ✓ Control line sheaves are 50mm (2") diameter and suit up to 8mm (5/16") rope.
- ✓ Twin rows of recirculating Torlon® ball bearings provide smooth, low friction performance for easy adjustment under load.
- ✓ Loop and fork style fittings suit becket or control line blocks to add extra purchase to control line systems.
- ✓ Stand-up spring kit RF324-2 provides support for a Series 60 or Series 75 single Orbit Block™ on mainsheet cars RC13003, RC13004, RC13012, RC13013, RC13023.

PRODUCT No.	DESCRIPTION	LENGTH	WIDTH	M.W.L.	B.L.	WEIGHT	LENGTH	WIDTH	M.W.L.	B.L.	WEIGHT
		mm	mm	kg	kg	g	in	in	lb	lb	oz
BB Ball Bearing											
RC13003	Car, pivoting shackle top, 2 mounting screws	100	77	860	2800	350	3 15/16	3 1/16	1900	6170	12.3
RC13004	Car, pivoting shackle top, 2 mounting screws	150	77	1650	3300	525	5 7/8	3 1/16	3640	7280	18.5
RC13012	Car, pivoting shackle top, single control sheaves	225	77	2200	4400	915	8 7/8	3 1/16	4840	9680	32.3
RC13013	Car, pivoting shackle top, double control sheaves	225	77	2200	4400	1070	8 7/8	3 1/16	4840	9680	37.7
RC13023	Car, pivoting shackle top, double control sheaves, adjustable C-Cleats™	225	77	2200	4400	1500	8 7/8	3 1/16	4840	9680	52.9
Accessories											
501003	Ball bearing, Torlon®, 7.95mm (5/16") diameter	-	-	-	-	1	-	-	-	-	0.1
RF324-2	Stand-up spring kit, suits RC13004, RC13012, RC13013, RC13023	-	-	-	-	60	-	-	-	-	2.1
RF1051	Control becket, 8mm (5/16") eye, suits RC13003 & RC13004	-	-	-	-	6	-	-	-	-	0.2
RF1053	Control becket fork, 5mm (3/16") pin, suits RC13003 & RC13004	-	14	-	-	9	-	9/16	-	-	0.3
RF74142	Series 75 Core Block™ stand-up kit, accepts up to 14mm (9/16") rope. Suits RC13004.	-	-	1500	3000	434	-	-	3300	6600	15.3



- ✓ Ball bearing cars have twin rows of recirculating Torlon® ball bearings for smooth adjustment under load.
- ✓ Genoa cars pivot to 45° from vertical for optimum alignment with sheet load.
- ✓ Genoa car sheaves are 75mm (3") diameter and accept two sheets for easy headsail changes.
- ✓ Alloy ball bearing sheaves available for enhanced performance.

- ✓ Cars with control sheaves can be matched with track control ends to create compact, low friction purchase systems for adjustment under load.
- ✓ Control line sheaves are 50mm (2") diameter and suit up to 8mm (5/16") rope.
- ✓ RC53030 sliderod car is a simple option for a sheet lead that does not require adjustment under load. Plunger stop can be locked in the "up" position.

- ⬆ Genoa sheet systems on boats to 17m (56ft).
- ⚙ Alloy track, cars and control ends.
- ⚙ Torlon® ball bearings in cars.
- ⚙ Acetal sliderods.
- ⚙ Acetal sheaves.
- ⚙ Grade 316 stainless steel fixtures.

PRODUCT No.	DESCRIPTION	LENGTH	WIDTH	M.W.L.	B.L.	WEIGHT	LENGTH	WIDTH	M.W.L.	B.L.	WEIGHT
		mm	mm	kg	kg	g	in	in	lb	lb	oz
BB Ball Bearing											
RC13031	Genoa car, single control sheave	200	77.0	1800	3200	1130	7 7/8	3 1/16	3970	7050	39.9
RC13033	Genoa car, double control sheaves	200	77.0	1800	3200	1227	7 7/8	3 1/16	3970	7050	43.3
SR Sliderod											
RC53030	Genoa car, sliderods, plunger stop	160	55.0	1700	3400	848	6 5/16	2 3/16	3750	7500	29.9
Accessories											
RF54000	Aluminium ball bearing control sheave, 50mm (2") diameter, suits RC13031, RC13033	-	-	-	-	32	-	-	-	-	1.1
RF78000W	Aluminium roller ball bearing sheave, 75mm (3") diameter, suits RC13033	-	-	-	-	280	-	-	-	-	9.9

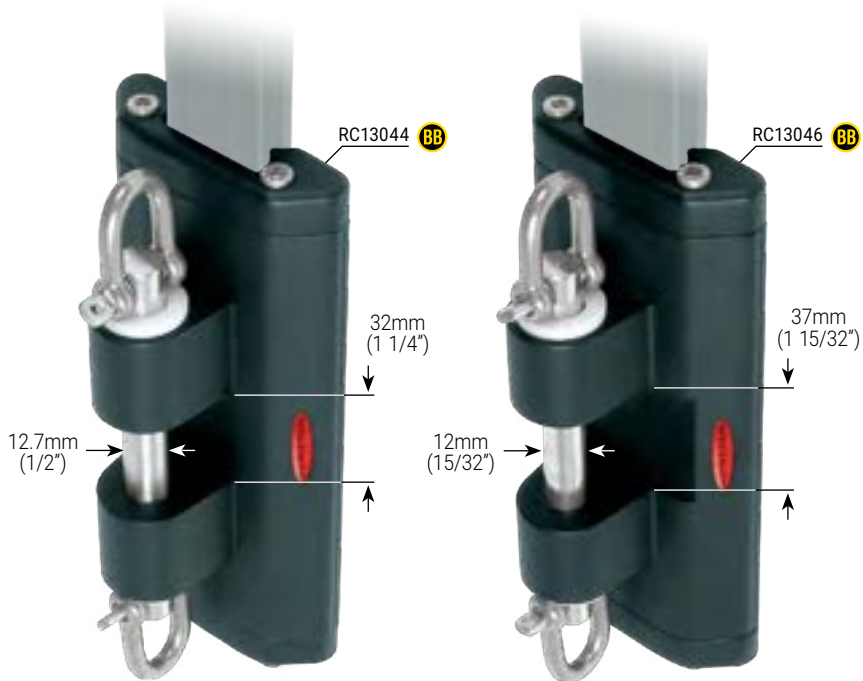

- ✔ Sliderod cars with pivoting shackle suit a variety of applications where a secure, adjustable take-off point for a block or control line is required.
- ✔ Plunger stop can be locked in the "up" position.
- ✔ Ball bearing spinnaker pole cars for boats to 15m (50ft) suit a variety of inboard end fittings.
- ✔ Alloy track, cars and control ends.
- ✔ Torlon® ball bearings.
- ✔ Grade 316 stainless steel fixtures.

PRODUCT No.	DESCRIPTION	LENGTH mm	WIDTH mm	M.W.L. kg	B.L. kg	WEIGHT g	LENGTH in	WIDTH in	M.W.L. lb	B.L. lb	WEIGHT oz
BB Ball Bearing											
RC13044	Spinnaker pole car, suits 32mm (1 1/4") toggle	175	77	1800	3600	720	6 7/8	3 1/16	3970	7940	25.4
RC13046	Spinnaker pole car, suits 37mm (1 15/32") toggle	175	77	1800	3600	695	6 7/8	3 1/16	3970	7940	24.5
SR Sliderod											
RC00481	Sliderods, suits RC13083 (pair)	53	8	-	-	8	2 1/16	5/16	-	-	0.3
RC00483	Sliderods, suits RC53003, RC53040 (pair)	98	8	-	-	16	3 7/8	5/16	-	-	0.6
RC00485	Sliderods, suits RC53030 (pair)	149	8	-	-	24	5 7/8	5/16	-	-	0.8
RC53003	Car, sliderods, pivoting shackle, internal control beackets	110	55	1325	2650	310	4 5/16	2 3/16	2920	5840	10.9
RC53040	Car, sliderods, pivoting shackle & plunger stop	110	55	1325	2650	355	4 5/16	2 3/16	2920	5840	12.5

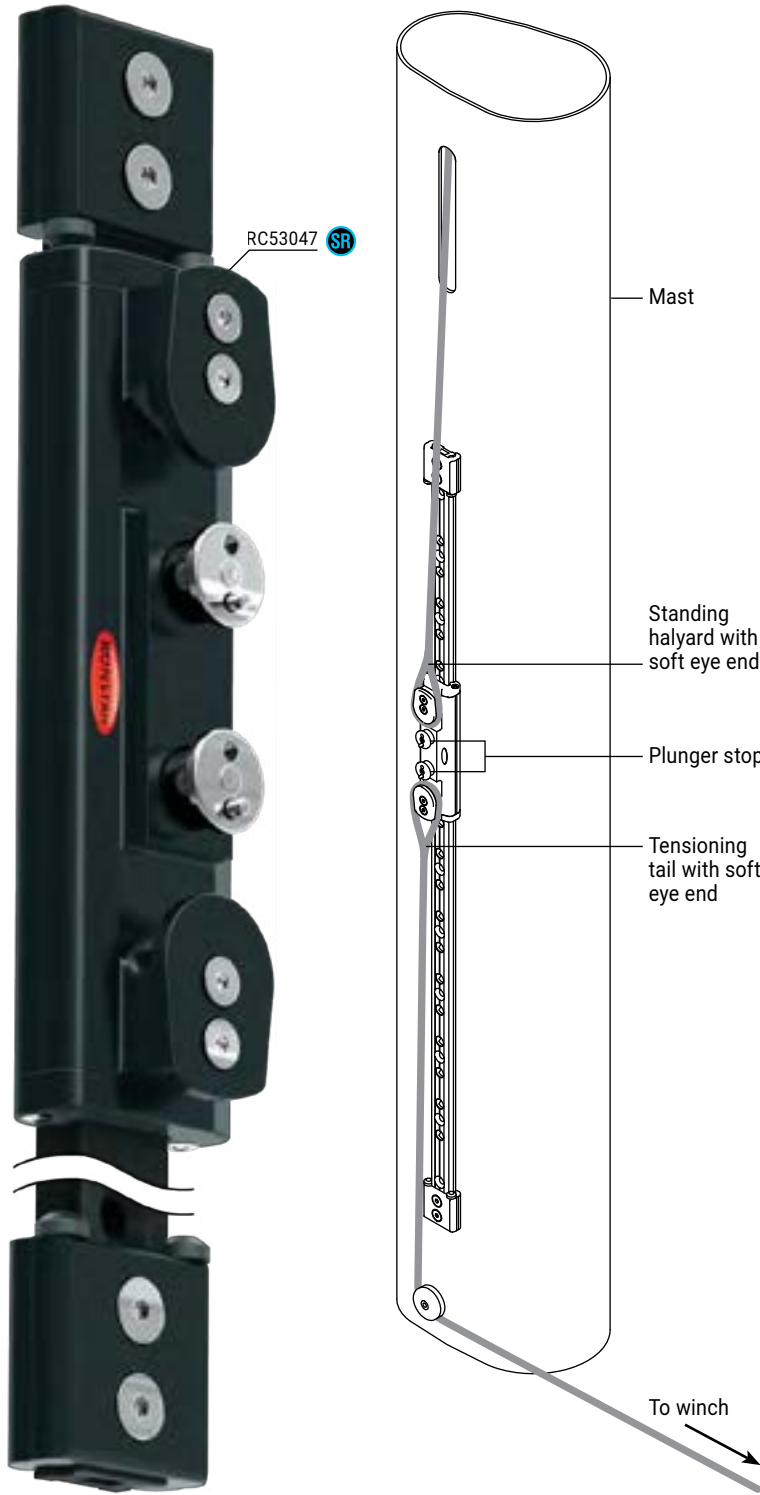

**HALYARD TAIL SYSTEM
TYPICAL SETUP**

For use with furling sails that are rarely lowered.

1. Car locked in position near the top of the track.
2. Sail hoisted until soft eye in end of standing halyard exits mast and can be placed over the upper attachment lug on the car.
3. Soft eye of tensioning halyard tail is placed over lower attachment lug on car.
4. When load is taken up by tensioning halyard tail, plunger stops are lifted and locked in the "up" (disengaged position).
5. Once desired halyard tension is achieved, plunger stops are released to engage with stop holes in the track.
6. When load has been transferred to the locked car, the tensioning halyard tail may be removed.

Note: 2:1 halyard may be used to reduce load for use on larger yachts.

TRACK FASTENINGS – 8mm (5/16") countersunk fasteners at 100mm (3 15/16") centres

STOP HOLES – Oversize at 50mm (1 31/32") centres

- ✔ System includes sliderod car, special 1231mm (48 15/32") Series 30 track and two low profile end stops.
- ✔ Car has 2 attachment lugs for the soft eye end of the halyard and tensioning tail.

- ✔ Car has dual oversize plunger stops that can be locked in the "up" position.
- ✔ The special track has oversize plunger stop holes at 50mm (1 31/32") spacing for the associated high loads, and is drilled and tapped to accept the low profile end stops.

- ⬆ Suitable for boats to 16m (53ft) with 1:1 halyard purchase.
- ⚙ Alloy track, car and end stops.
- ⚙ Acetal sliderods.
- ⚙ Grade 316 stainless steel fixtures.

PRODUCT No.	DESCRIPTION	LENGTH	WIDTH	M.W.L.	B.L.	WEIGHT	LENGTH	WIDTH	M.W.L.	B.L.	WEIGHT
		mm	mm	kg	kg	g	in	in	lb	lb	oz
RC53047	Halyard tail system. Sliderod car, includes 2 x plunger stop and 2 x attachment lugs, 1231mm (48 15/32") special track, 2 x low profile end stops	210	575	2300	4600	1940	8 1/4	2 15/16	5060	10120	68.4





- ✔ Traveller control ends are suited for mainsheet systems on boats to 17m (56ft).
- ✔ Control line sheaves are 50mm (2") diameter and suit up to 8mm (5/16") rope.
- ✔ Cleat addition kits are adjustable for optimum cleating angle.
- ✔ Control ends can also be used to create purchase systems for genoa lead adjustment under load.
- ✔ Adjustable stops can be fitted on track aft of genoa cars and used to relieve load on adjustment tackle.
- ✔ Control ends can be fitted with RC13081P cover plate to control track end.

PRODUCT No.	DESCRIPTION	LENGTH	WIDTH	M.W.L.	B.L.	WEIGHT	LENGTH	WIDTH	M.W.L.	B.L.	WEIGHT
		mm	mm	kg	kg	g	in	in	lb	lb	oz
Accessories											
RC00424	Control end C-Cleat™ addition kit, suits RC13084, RC13085, RC13086, RC13087	-	-	-	-	215	-	-	-	-	7.6
RC13081	End stop, aluminium	58	55	-	-	89	2 9/32	2 3/16	-	-	3.1
RC13081P	Cover plate for control end, including screws	-	55	-	-	16	-	2 3/16	-	-	0.6
RC13083	Adjustable stop	77	55	-	-	190	3	2 3/16	-	-	6.7
RC13084	Control end, single sheave	115	55	450	1350	250	4 1/2	2 3/16	990	2980	8.8
RC13085	Control end, single sheave & becket	115	55	675	1350	315	4 1/2	2 3/16	1490	2980	11.1
RC13086	Control end, double sheaves	115	55	675	1350	315	4 1/2	2 3/16	1490	2980	11.1
RC13087	Control end, double sheaves & becket	115	55	675	1350	580	4 1/2	2 3/16	1490	2980	20.5
RF54000	Aluminium ball bearing control sheave, 50mm (2") diameter, suits RC13084, RC13085, RC13086, RC13087	-	-	-	-	32	-	-	-	-	1.1



© Italia Yachts

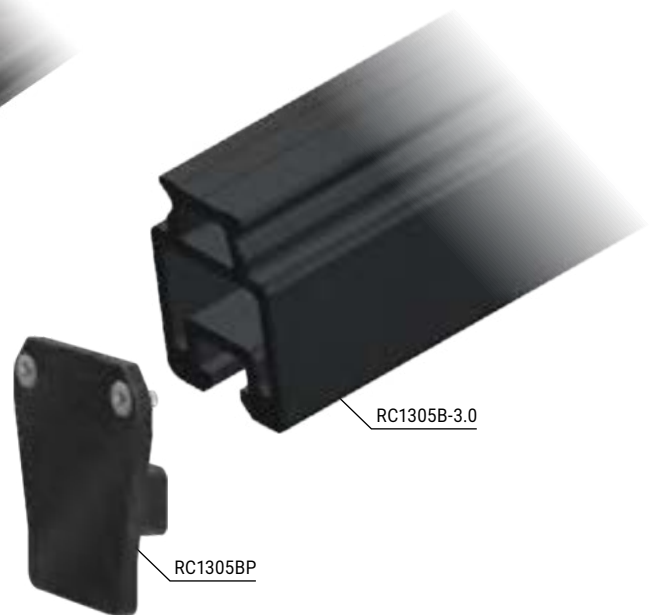
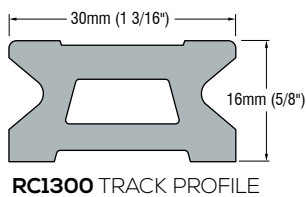

TRACK FASTENINGS – 8mm (5/16") countersunk fasteners at 100mm (3 15/16") centres **STOP HOLES** – 50mm (1 31/32") centres

- ✔ Beam track can be used for unsupported spans to bridge cockpits and companionway hatches. They are supplied without fastener or stop holes. See page 130 for mechanical data.
- ✔ Standard low profile track has stop holes for cars fitted with plunger stops.
- ✔ Refer to page 131 for track bending.
- ⚙ Mainsheet and genoa sheet systems on boats to 17m (56ft).
- ⚙ Alloy track.

PRODUCT No.	DESCRIPTION	LENGTH	WIDTH	WEIGHT	LENGTH	WIDTH	WEIGHT
		mm	mm	g	mm	mm	oz
Accessories							
RC1300-1.0*1	Track, black	996	30	810	39 3/16	1 3/16	28.6
RC1300-2.0*1	Track, black	1996	30	1620	78 9/16	1 3/16	57.1
RC1300-3.0*1&2	Track, black	2996	30	2430	117 15/16	1 3/16	85.7
RC1301J	Track joiner	60	-	7	2 3/8	-	0.2
RC1305B-3.0*1	Beam track, black. 42mmW x 58mmH (1 21/32"W x 2 9/32"H)	2996	42	8490	117 15/16	1 21/32	299.4
RC1305BP	Cover plate for control end including screws, suits RC1305B beam track	-	76	42	-	3	1.5
RC13080	End cap, plastic	37	37	27	1 7/16	1 7/16	1.0

*1 Silver track available - Order as RCxxxxxxS

*2 Longer track available on request.





© Contest Yachts



- ✔ Low profile, lightweight alloy cars and end caps.
- ✔ Twin rows of recirculating Torlon® ball bearings provide smooth, low friction performance for easy adjustment under load.
- ✔ RC14205 Orbit Car has an integral attachment point for lashings.
- ✔ RC14214 suits use with RF109100 Series 100 Orbit Block™ for a 2:1 mainsheet system 60mm (2 3/8") diameter roller ball bearing control sheaves suit up to 14mm (9/16") rope.
- ✔ RC14215 accepts two RF79100 Orbit Blocks™ or similar. 50mm (2") diameter control sheaves suit up to 8mm (5/16") diameter line.
- ✔ Stand-up spring kit RF324 provides support for a Series 60 or Series 75 Orbit Block™ on mainsheet.
- ⬆ Mainsheet systems on boats to 25m (82ft).
- ⬆ Self-tacking jib systems on boats to 20m (65ft).
- ⬆ Multihull mainsheet systems on boats to 19m (62ft).
- ✔ Torlon® ball bearings (cars).
- ✔ Torlon® rollers (RC14218A sheaves).
- ✔ Alloy (RC14214) or acetal (RC14215) control sheave.
- ✔ Acetal ball bearings (RC14214 sheaves).
- ✔ Alloy (RC14214) or stainless steel (RC14215) cheeks.
- ✔ Grade 316 stainless steel fixtures.

PRODUCT No.	DESCRIPTION	LENGTH	WIDTH	M.W.L.	B.L.	WEIGHT	LENGTH	WIDTH	M.W.L.	B.L.	WEIGHT
		mm	mm	kg	kg	g	in	in	lb	lb	oz
BB Ball Bearing											
RC14205	Orbit Car, integrated lashing eye	145	96	2200	4400	531	5 3/4	3 13/16	4840	9680	18.7
RC14214	Car, single block take-off, single 60mm (2 3/8") roller ball bearing control sheaves	270	96	3000	6000	1820	10 5/8	3 13/16	6610	13230	64.2
RC14215	Car, 2 x block take-offs, double 50mm (2") control sheaves	340	96	4500	9000	2225	13 3/8	3 13/16	9900	19800	78.5
Accessories											
RF324	Stand-up spring, suits Series 60 & 75 single Orbit Blocks™ and Core Blocks™	-	-	-	-	80	-	-	-	-	2.8
RF54000	Aluminium ball bearing control sheave, 50mm (2") diameter, suits RC14215	-	-	-	-	32	-	-	-	-	1.1



- ✔ Twin rows of recirculating Torton® ball bearings provide smooth, low friction performance for easy adjustment under load.
- ✔ RC14215A tandem car runs on straight or curved track (in a horizontal plane). It has a pivoting bridge plate assembly with take-off points for lashing of mainsheet blocks and control line blocks.

- ✔ RC14218A with pivoting mainsheet sheave unit is a premium compact and low profile solution for a 2:1 mainsheet system. The central roller maintains sheet alignment and low friction when reaching with sheet eased and traveller car to leeward.
- ⚡ Mainsheet systems on boats to 24m (78ft).
- ⚡ Self-tacking jib systems on boats to 20m (65ft).

- ⚡ Multihull mainsheet systems on boats to 19m (62ft).
- ⚡ Torton® ball bearings (cars) and rollers (sheaves).
- ⚡ Alloy cheeks and sheaves.
- ⚡ Acetal ball bearings (sheaves).
- ⚡ Grade 316 stainless steel fixtures.

PRODUCT No.	DESCRIPTION	LENGTH mm	WIDTH mm	M.W.L. kg	B.L. kg	WEIGHT g	LENGTH in	WIDTH in	M.W.L. lb	B.L. lb	WEIGHT oz
BB Ball Bearing											
RC14215A	Tandem car, pivoting bridge plate with take-off points for mainsheet and control line blocks	485	96	6700	13400	4800	19 1/8	3 13/16	14740	29480	169.3
RC14218A	Car, stirrup with 2 x 125mm (5") Orbit sheaves, single 75mm (3") Orbit control line sheaves	435	96	5000	10000	7200	17 1/8	3 13/16	11000	22000	253.9
Accessories											
501004	Ball bearing, Torton®, 9.53mm (3/8") diameter	-	-	-	-	1	-	-	-	-	0.1



- ✓ Low profile, lightweight alloy cars and end caps.
- ✓ High performance roller ball bearing sheaves can accept two sheets for easy headsail changes.
- ✓ Highly polished stainless steel stirrups and lead block connectors pivot 45° from vertical for optimum alignment with sheet loads.
- ✓ Plunger stops can be locked in the "up" position.

- ✓ RC54230 and RC54230A sliderod, plunger stop cars are a simple solution for applications where adjustment under load is not required. They can be easily fitted and removed from tracks.
- ✓ RC14231A and RC14231B genoa cars have a towing lug and twin rows of recirculating Torlon® ball bearings for easy adjustment under load. Custom variants are available with an additional lug aft for towing cars in series.

- ⤴ Genoa sheet systems on boats to 25m (82ft).
- ⚙ Alloy car bodies, end caps and sheaves.
- ⚙ Torlon® ball bearings (cars) and rollers (sheaves).
- ⚙ Acetal ball bearings (sheaves).
- ⚙ Grade 316 stainless steel stirrups, cheeks & fixtures.

PRODUCT No.	DESCRIPTION	SHEAVE						SHEAVE					
		DIAM.	LENGTH	WIDTH	M.W.L.	B.L.	WEIGHT	DIAM.	LENGTH	WIDTH	M.W.L.	B.L.	WEIGHT
		mm	mm	mm	kg	kg	g	in	in	in	lb	lb	oz
BB Ball Bearing													
RC14231A	Genoa car, towing lug	100	300	96	3500	7000	2950	4	11 3/4	3 25/32	7700	15400	104.0
RC14231B	Genoa car, towing lug	125	300	96	5000	10000	3450	5	11 3/4	3 25/32	11000	22000	121.7
SR Sliderod													
RC54230	Genoa car, sliderods, plunger stop	100	230	75	3500	7000	2300	4	9	2 15/16	7700	15400	81.3
RC54230A	Genoa car, sliderods, plunger stop	125	230	75	5000	10000	2790	5	9	2 15/16	11000	22000	98.6



© Armare

© Nicola Broilo - Italia Yachts



- ✔ Low profile, lightweight alloy cars and end caps.
- ✔ Highly polished stainless steel block assemblies pivot 45° from vertical for optimum alignment with sheet loads.

- ✔ Genoa cars have a towing lug and twin rows of recirculating Torlon® ball bearings for easy adjustment under load. Custom variants are available with an additional lug aft for towing cars in series.

- ⚙ Genoa sheet systems on boats to 25m (82ft).
- ⚙ Alloy car bodies, end caps and sheaves.
- ⚙ Torlon® ball bearings.
- ⚙ Grade 316 stainless steel stirrups, cheeks & fixtures.

PRODUCT No.	DESCRIPTION	SHEAVE DIAM.	LENGTH	WIDTH	M.W.L.	B.L.	WEIGHT	SHEAVE DIAM.	LENGTH	WIDTH	M.W.L.	B.L.	WEIGHT
		mm	mm	mm	kg	kg	g	in	in	in	lb	lb	oz
BB Ball Bearing													
RC14236	Genoa car, towing lug, stainless steel block	100	280	96	4000	8000	3680	4	11	3 25/32	8800	17600	129.8
RC14236A	Genoa car, towing lug, stainless steel block	125	280	96	5500	11000	4600	5	11	3 25/32	12100	24200	162.2
Accessories													
501004	Ball bearing, Torlon®, 9.53mm (3/8") diameter	-	-	-	-	-	1	-	-	-	-	-	0.1

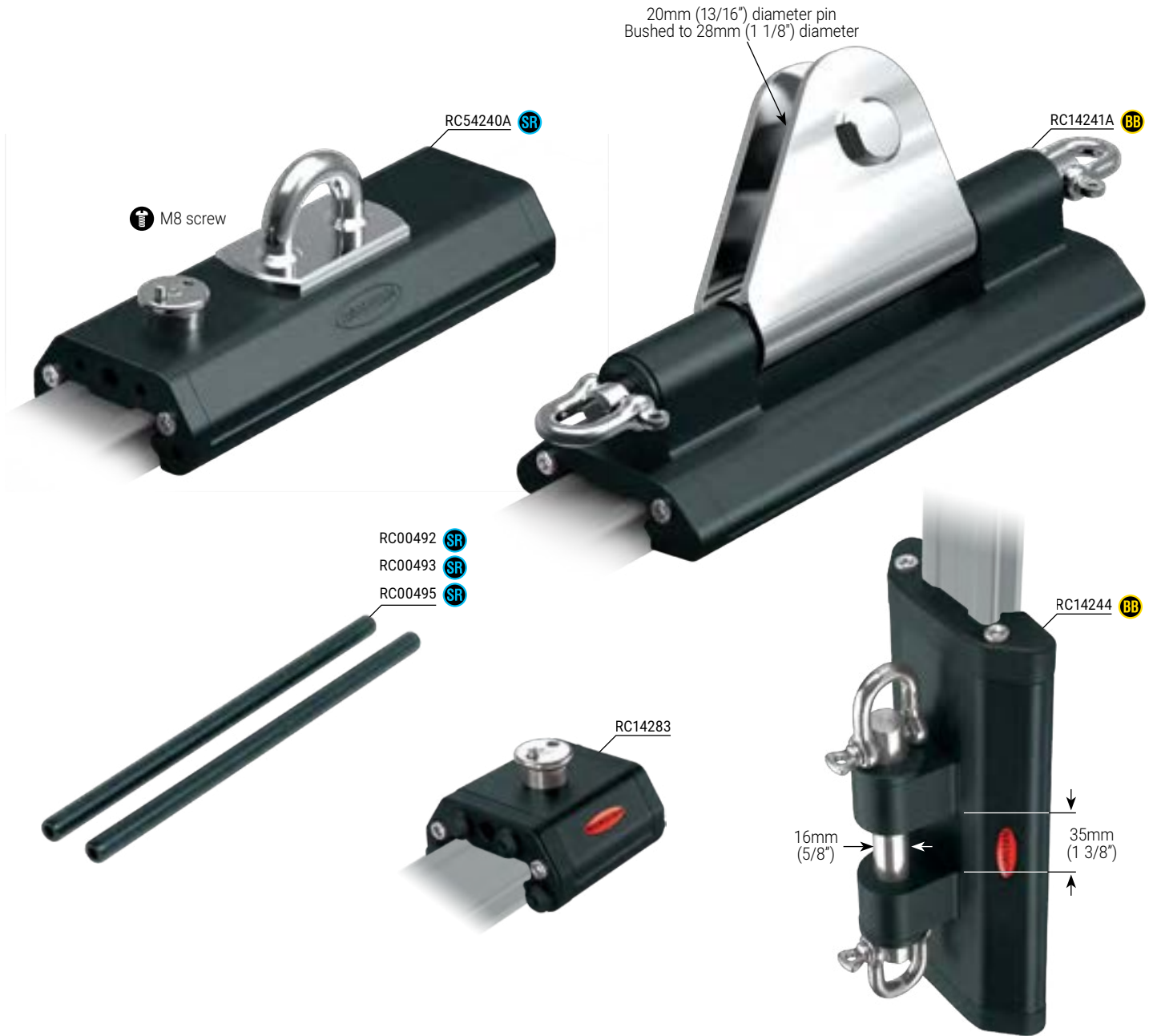

- ✓ Adjustable stops can be fitted on track aft of genoa cars and used to relieve load on adjustment tackle.
- ✓ Sliderod car with padeye suits a variety of applications where a secure, adjustable take-off point for a block or control line is required.
- ✓ Plunger stops can be locked in the "up" position.

- ⬆ Outhaul car suitable for boats to 24m (78ft) with conventional reefing or in-mast furling systems.
- ⬆ Ball bearing spinnaker pole car for boats to 24m (78ft) suits inboard end fittings with 35mm (1 3/8") toggle.
- ⚙ Alloy car bodies and end caps.

- ⚙ Torlon® ball bearings.
- ⚙ Acetal sliderods.
- ⚙ Grade 316 stainless steel fixtures.

PRODUCT No.	DESCRIPTION	LENGTH	WIDTH	M.W.L.	B.L.	WEIGHT	LENGTH	WIDTH	M.W.L.	B.L.	WEIGHT
		mm	mm	kg	kg	g	in	in	lb	lb	oz
BB Ball Bearing											
RC14244	Spinnaker pole car, suits toggle	230	96.0	3700	7400	1370	9	3 13/16	8160	16310	48.3
RC14241A	Outhaul car, 20mm (13/16") clew pin	280	75.0	4500	9000	3250	11	2 15/16	9900	19800	114.6
SR Sliderod											
RC00492	Sliderods, suit RC54230, RC54230A (pair)	196	9.4	-	-	43	7 3/4	3/8	-	-	1.5
RC00493	Sliderods, suit RC14283 (pair)	53	9.4	-	-	12	2 1/16	3/8	-	-	0.4
RC00495	Sliderods, suit RC54240A (pair)	173	9.4	-	-	38	6 13/16	3/8	-	-	1.3
RC14283	Adjustable stop	85	75.0	-	-	390	3 3/8	2 15/16	-	-	13.8
RC54240A	Car, sliderods, padeye top & plunger stop	205	75.0	3500	7000	1100	8	2 15/16	7720	15430	38.8

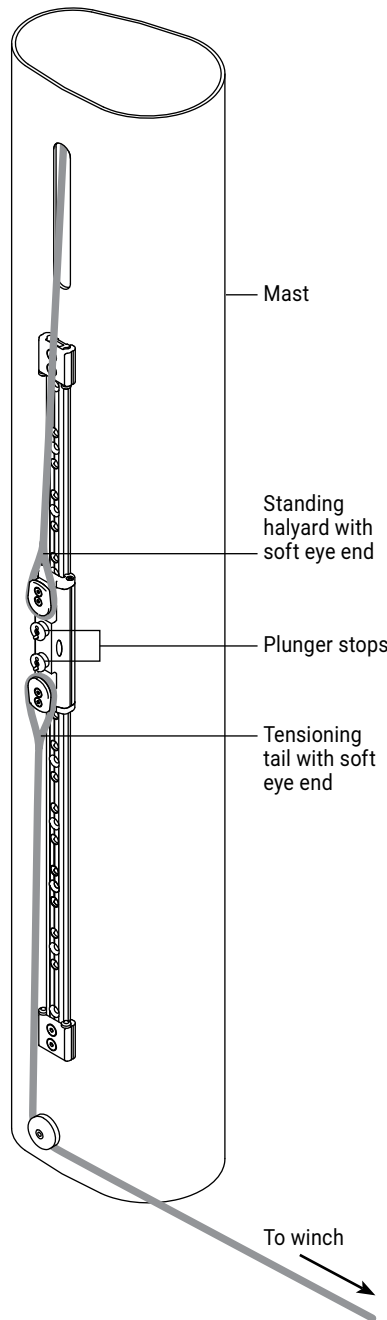

RC54247

**HALYARD TAIL SYSTEM
TYPICAL SETUP**

For use with furling sails that are rarely lowered.

1. Car locked in position near the top of the track.
2. Sail hoisted until soft eye in end of standing halyard exits mast and can be placed over the upper attachment lug on the car.
3. Soft eye of tensioning halyard tail is placed over lower attachment lug on car.
4. When load is taken up by tensioning halyard tail, plunger stops are lifted and locked in the "up" (disengaged position).
5. Once desired halyard tension is achieved, plunger stops are released to engage with stop holes in the track.
6. When load has been transferred to the locked car, the tensioning halyard tail may be removed.

Note: 2:1 halyard may be used to reduce load for use on larger yachts.

TRACK FASTENINGS – 10mm (3/8") countersunk fasteners at 100mm (3 15/16") centres
STOP HOLES – Oversized at 50mm (1 31/32") centres

- System includes sliderod car, special 1560mm (61 13/32") Series 42 track and two low profile end stops.
- The special track has oversized plunger stop holes at 50mm (1 31/32") spacing for the associated high loads, and is drilled and tapped to accept the low profile end stops.
- Car has 2 attachment lugs for the soft loop end of the halyard and tensioning tail.
- Car has dual oversized plunger stops that can be locked in the "up" position.
- Suitable for boats to 25m (82ft) with 1:1 halyard purchase.
- Alloy track, car and end stops.
- Acetal sliderods.
- Grade 316 stainless steel fixtures.

PRODUCT No.	DESCRIPTION	LENGTH	WIDTH	M.W.L.	B.L.	WEIGHT	LENGTH	WIDTH	M.W.L.	B.L.	WEIGHT
		mm	mm	kg	kg	g	in	in	lb	lb	oz
Sliderod											
RC54247	Halyard tail system. Sliderod car, includes 2 x plunger stops and 2 x attachment lugs, 1560mm (61 13/32") special track, 2 x low profile end stops	280	75	4000	8000	4300	11	2 15/16	8800	17600	151.7

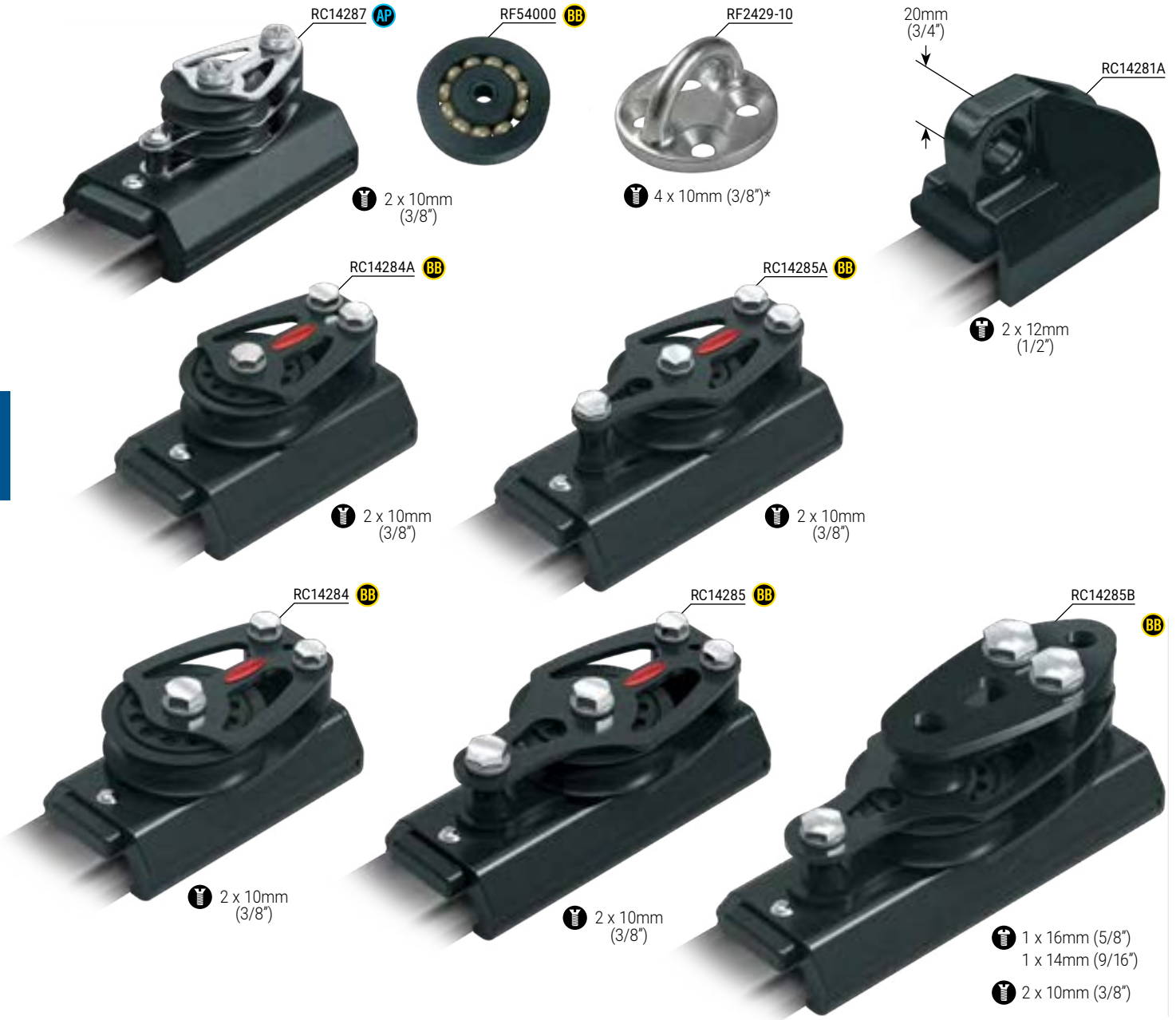

- ✓ Traveller control ends include a cover plate to conceal track end.
- ✓ RC14287 has 50mm (2") diameter sheaves which suit up to 8mm (5/16") rope.
- ✓ RC14284A and RC14285A have a 60mm (2 3/8") diameter roller ball bearing sheave which suits up to 14mm (9/16") rope.
- ✓ RC14284 and RC14285 have a 75mm (3") diameter roller ball bearing sheave which suits up to 14mm (9/16") rope.
- ✓ RC14285B has 75mm (3") diameter roller ball bearing sheave which suits up to 14mm (9/16") rope. It also has an upper becket to dead end a mainsheet up to 20mm (3/4") diameter.
- ✓ Padeyes are typically used for termination of 2:1 control line systems on deck.
- ⬆ Mainsheet systems on boats to 24m (78ft).
- ⬆ Genoa sheet systems on boats to 25m (82ft).
- ⬆ Self-tacking jib systems on boats to 20m (65ft).
- ⬆ Multihull mainsheet systems on boats to 19m (62ft).

PRODUCT No.	DESCRIPTION	LENGTH mm	WIDTH mm	M.W.L. kg	B.L. kg	WEIGHT g	LENGTH in	WIDTH in	M.W.L. lb	B.L. lb	WEIGHT oz
BB RF2429-10	Control line padeye (see page 209 for further details)	72	72	-	9000*	240	2 3/4	2 3/4	-	19800*	8.5
RF54000	Aluminium ball bearing control sheave, 50mm (2") diameter, suits RC14287	-	-	-	-	32	-	-	-	-	1.1
RC14281A	End stop, aluminium, with mainsheet take-off point, end cover plate	98	55	2000	4000	360	3 7/8	2 3/16	4400	8800	12.7
RC14284	Control end, 75mm (3") diameter sheave, end cover plate	135	75	1750	3500	932	5 5/16	2 15/16	3850	7700	32.9
RC14284A	Control end, 60mm (2 3/8") diameter sheave, end cover plate	126	75	1500	3000	680	5	2 15/16	3300	6600	24.0
RC14285	Control end, 75mm (3") diameter sheave & becket, end cover plate	170	75	1750	3500	1138	6 3/4	2 15/16	3850	7700	40.1
RC14285A	Control end, 60mm (2 3/8") diameter sheave & becket, end cover plate	154	75	1500	3000	910	7 1/4	2 15/16	3300	6600	32.1
RC14285B	Control end, 75mm (3") diameter sheave & becket, mainsheet dead end attachment point, end cover plate	217	75	3000	6000	1400	8 9/16	2 15/16	6600	13200	49.4
RC14287	Control end, 50mm (2") diameter double sheaves & becket, end cover plate	138	75	675	1350	800	5 3/8	2 15/16	1485	2970	28.2

* A4-80 DIN7991 grade fasteners recommended to achieve BL



© Najad – Yachts of Sweden

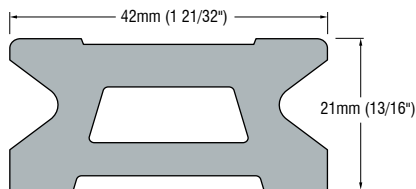

RC1420 TRACK PROFILE

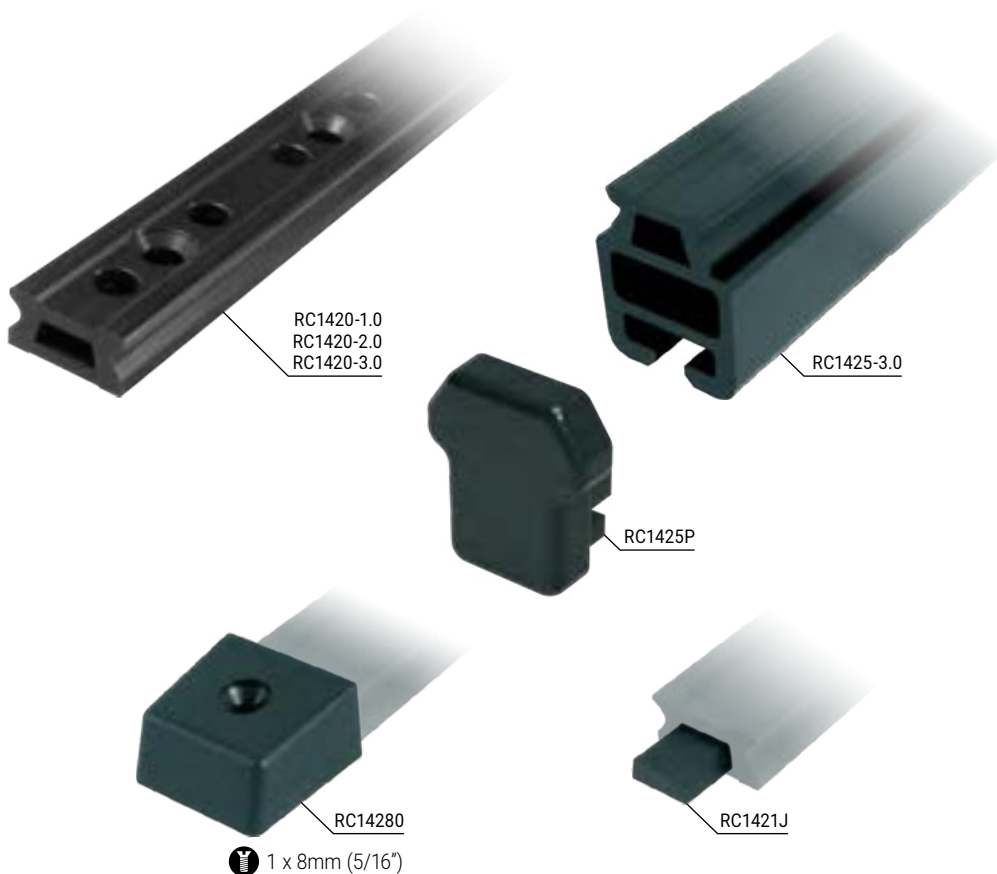

TRACK FASTENINGS – 10mm (3/8") countersunk fasteners at 100mm (3 15/16") centres **STOP HOLES** – 50mm (1 31/32") centres

- ✔ Standard low profile track has stop holes for cars fitted with plunger stops.
- ✔ Beam track can be used for unsupported spans to bridge cockpits and companionway hatches. See page 130 for mechanical data.
- ✔ RC14281 end stop includes cover plate to conceal track end.
- ✔ RC1421J track joiner aids alignment when joining track sections.
- ⚙ Mainsheet systems on boats to 24m (78ft).
- ⚙ Genoa sheet systems on boats to 25m (82ft).
- ⚙ Self-tacking jib systems on boats to 20m (65ft).
- ⚙ Multihull mainsheet systems on boats to 19m (62ft).

PRODUCT No.	DESCRIPTION	LENGTH mm	WIDTH mm	M.W.L. kg	B.L. kg	WEIGHT g	LENGTH in	WIDTH in	M.W.L. lb	B.L. lb	WEIGHT oz
BB Ball Bearing											
RC1420-1.0*1	Track, black	996	42	-	-	1430	39 3/16	1 5/8	-	-	50.4
RC1420-2.0*1	Track, black	1996	42	-	-	2860	78 9/16	1 5/8	-	-	100.9
RC1420-3.0*1&2	Track, black	2996	42	-	-	4290	117 15/16	1 5/8	-	-	151.3
RC1421J	Track joiner	60	-	-	-	17	2 3/8	-	-	-	0.6
RC1425-3.0*1	Beam track, black. 56mmW x 71mmH (2 3/16"W x 2 25/32"H)	2996	56	-	-	13810	117 15/16	2 3/16	-	-	488.0
RC1425P	End plug for RC1425-3.0 beam track	-	-	-	-	135	-	-	-	-	4.8
RC14280	End cap, plastic	50	49	-	-	20	2	2	-	-	0.7
RC14281	End stop, aluminium, including end cover plate	84	75	-	-	345	3 1/4	2 15/16	-	-	12.2

* 1 Silver track available - Order as RCxxxxxS
 * 2 Longer track available on request.



© Scandinavia Yachts



RC15505 **BB**



RC15515 **BB**

- ✔ Precision machined bodies and Torlon® ball bearings ensure free running performance even under extreme loads.
- ✔ Custom solutions can be developed to suit individual requirements.
- ✔ RC15505 Orbit Car has two integral attachment points for lashings.

- ✔ RC15515 mainsheet car runs on straight or curved track (in a horizontal plane). It has a pivoting bridge plate assembly with take-off points for lashing of mainsheet blocks and control line blocks.
- ⚡ Main and mizzen sheet systems on monohulls to 36m (120ft), or multihulls to 23m (75ft).
- ⚡ Self-tacking jib systems on boats 23m (75ft) and above.

- ⚡ Torlon® ball bearings.
- ⚡ Alloy bridge plates.
- ⚡ Grade 316 stainless steel fixtures.

PRODUCT No.	DESCRIPTION	LENGTH	WIDTH	M.W.L.	B.L.	WEIGHT	LENGTH	WIDTH	M.W.L.	B.L.	WEIGHT
		mm	mm	kg	kg	g	in	in	lb	lb	oz
BB Ball Bearing											
RC15505	Orbit Car, 2 x integrated link/lashing eye	290	125	5000	10000	2000	11 1/2	4 15/16	11000	22000	70.5
RC15515	Tandem car, pivoting bridge plate with take-off points for mainsheet and control line blocks	575	125	9500	19000	11600	22 5/8	4 15/16	20900	41800	409.1



✓ RC15518A with pivoting mainsheet sheave unit is a premium compact and low profile solution for a 2:1 mainsheet system. The central roller maintains sheet alignment and low friction when reaching with sheet eased and traveller car to leeward. 75mm (3") diameter control sheaves suit up to 14mm (9/16") rope.

✓ Precision machined bodies and Torlon® ball bearings ensure free running performance even under extreme loads.

✓ Custom solutions can be developed to suit individual requirements.

⚠ Main and mizzen sheet systems on monohulls to 36m (120ft), or multihulls to 23m (75ft).

⚠ Self-tacking jib systems on boats 23m (75ft) and above.

⚙ Torlon® ball bearings (cars) and rollers (RC15518A sheaves).

⚙ Alloy cheek/pivot plates and sheaves.

⚙ Acetal ball bearings (sheaves).

⚙ Grade 316 stainless steel fixtures.

PRODUCT No.	DESCRIPTION	LENGTH mm	WIDTH mm	M.W.L. kg	B.L. kg	WEIGHT g	LENGTH in	WIDTH in	M.W.L. lb	B.L. lb	WEIGHT oz
BB Ball Bearing											
RC15518A	Car, pivoting mainsheet sheave stirrup with 2 x 150mm (6") diameter Orbit sheaves, single 75mm (3") diameter Orbit control sheaves	470	125	6000	12000	10500	18 1/2	4 15/16	13200	26500	370.3
Accessories											
501005	Ball bearing, Torlon®, 12.7mm (1/2") diameter	-	-	-	-	1	-	-	-	-	0.1



- ✓ High performance roller ball bearing sheaves for low friction performance can accept two sheets for easy headsail changes.
- ✓ Highly polished stainless steel stirrups pivot 45° from vertical for optimum alignment with sheet loads.
- ✓ Custom solutions can be developed to suit individual requirements.

- ✓ Adjustable stops can be used as a backup to lock a car into position. The plunger stop can be locked in the "up" position.
- ✓ Genoa cars have a towing lug and twin rows of recirculating Teflon® ball bearings for easy adjustment under load. Custom variants are available with an additional lug aft for towing cars in series.

- ⚙ Genoa sheet systems on boats 28m (92ft) and above.
- ⚙ Alloy car bodies, end caps and sheaves.
- ⚙ Teflon® ball bearings (cars) and rollers (sheaves).
- ⚙ Acetal ball bearings (sheaves).
- ⚙ Grade 316 stainless steel stirrups, cheeks and fixtures.

PRODUCT No.	DESCRIPTION	SHEAVE	LENGTH	WIDTH	M.W.L.	B.L.	WEIGHT	SHEAVE	LENGTH	WIDTH	M.W.L.	B.L.	WEIGHT
		DIAM.						DIAM.					
		mm	mm	mm	kg	kg	g	in	in	in	lb	lb	oz
BB Ball Bearing													
RC15531	Genoa car, towing lug	150	350	125	6500	13000	6400	6	13 3/4	4 15/16	14300	28600	225.7
RC15531A	Genoa car, towing lug	180	460	125	9650	19300	9300	7	18 1/8	4 15/16	21200	42400	328.0
SR Sliderod													
RC15583	Stop, adjustable	-	185	125	-	-	2050	-	15 3/8	4 15/16	-	-	72.3



- ✔ Genoa cars have a towing lug and twin rows of recirculating Torlon® ball bearings for easy adjustment under load. Custom variants are available with an additional lug aft for towing cars in series.
- ✔ Highly polished stainless steel block assemblies pivot 45° from vertical for optimum alignment with sheet loads.
- ✔ Custom solutions can be developed to suit individual requirements.
- ✔ RC15541 outhaul car is suitable for monohulls to 36m (118ft) or multihulls to 23m (75ft). The M18 threaded rod at the forward end suits connection to a hydraulic ram.
- ✔ Genoa cars are suitable for sheet systems on boats 28m (92ft) and above.
- ✔ Alloy car bodies, end caps and sheaves.
- ✔ Torlon® ball bearings.
- ✔ Grade 316 stainless steel stirrups, cheeks and fixtures.

PRODUCT No.	DESCRIPTION	SHEAVE	LENGTH	WIDTH	M.W.L.	B.L.	WEIGHT	SHEAVE	LENGTH	WIDTH	M.W.L.	B.L.	WEIGHT
		DIAM.						DIAM.					
		mm	mm	mm	kg	kg	g	in	in	in	lb	lb	oz
BB Ball Bearing													
RC15536	Genoa car, towing lug, stainless steel block	125	345	125	6900	13800	7200	5	39/16	4 15/16	15200	30400	253.9
RC15536A	Genoa car, towing lug, stainless steel block	150	345	125	10000	20000	7900	6	39/16	4 15/16	22000	44000	278.6
RC15541	Outhaul car, M18 stud	-	390	125	6500	13000	8200	-	15 3/8	4 15/16	14300	28600	289.2
Accessories													
501005	Ball bearing, Torlon®, 12.7mm (1/2") diameter	-	-	-	-	-	1	-	-	-	-	-	0.1

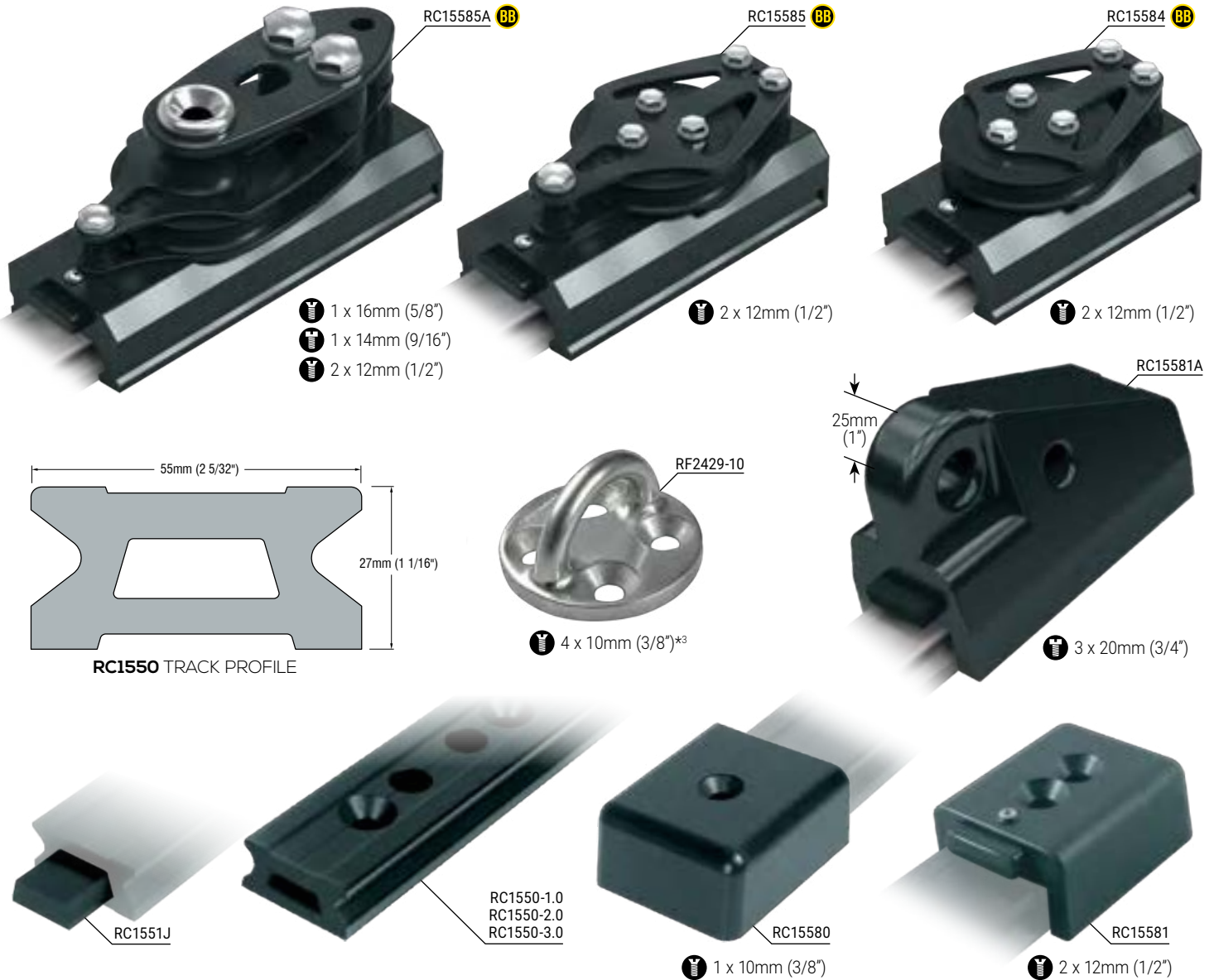

TRACK FASTENINGS – 12mm (1/2") countersunk fasteners at 100mm (3 15/16") centres **STOP HOLES** – 50mm (1 31/32") centres

- ✓ Traveller control ends have high performance roller ball bearing sheaves.
- ✓ Traveller control ends include a cover plate to conceal the end track.
- ✓ Custom control ends can be developed to suit individual requirements.
- ✓ Standard low profile track has stop holes for cars fitted with plunger stops.
- ✓ Padeyes are typically used for termination of 2:1 mainsheet systems on deck.
- ✓ RC15584, RC15585 and RC15585A have a 100mm (4") diameter sheave which suits up to 14mm (9/16") rope.
- ✓ RC15585A has an upper becket to dead end a mainsheet up to 20mm (3/4") diameter.
- ✓ RC15581A end stop has an integrated ID 25mm (15/16") mainsheet dead end/attachment point and an ID 19mm (3/4") dead end attachment point for a control line, and/or boom bridle.
- ☞ Alloy track and control end bodies.

PRODUCT No.	DESCRIPTION	LENGTH mm	WIDTH mm	M.W.L. kg	B.L. kg	WEIGHT g	LENGTH in	WIDTH in	M.W.L. lb	B.L. lb	WEIGHT oz
BB Ball Bearing											
RC1550-1.0*1	Track, black	996	55	-	-	2400	39 3/16	2 3/16	-	-	84.7
RC1550-2.0*1	Track, black	1996	55	-	-	4800	78 9/16	2 3/16	-	-	169.3
RC1550-3.0*1&2	Track, black	2996	55	-	-	7200	117 15/16	2 3/16	-	-	254.0
RC1551J	Track joiner	60	-	-	-	30	2 3/8	-	-	-	1.1
RC15580	End cap, plastic	85	75	-	-	155	3 3/8	2 15/16	-	-	5.5
RC15581	End stop, aluminium	110	76	-	-	477	4 5/16	2 31/32	-	-	16.8
RC15581A	End stop, aluminium, with mainsheet take-off point, end cover plate	190	85	6000	12000	2250	7 1/2	3 3/8	13200	26400	79.4
RC15584	Control end, 100mm (4") sheave	170	102	2800	5600	2140	6 11/16	4	6150	12300	75.5
RC15585	Control end, 100mm (4") sheave & becket	210	102	2800	5600	2140	8 1/4	4	6150	12300	75.5
RC15585A	Control end, 100mm (4") sheave & becket, mainsheet dead end attachment point	265	102	4100	8200	3380	10 7/16	4	9000	18000	119.2
RF2429-10	Control line padeye (see page 209 for further details)	72	72	-	9000*3	240	2 3/4	2 3/4	-	19800*3	8.5

*1 Silver track available - Order as RCxxxxxxS
 *2 Longer track available on request.
 *3 A4-80 DIN7991 grade fasteners recommended to achieve BL



- Beam tracks are typically used to span cockpits, companionways and unsupported deck sections, where fastening options are restricted or to avoid the need for building additional support structure into the boat.
- Sectional and mechanical data, including moments of inertia (I_x & I_y) and cross sectional area (CSA) are shown below for the various beam sections. Designer or builder should be consulted to determine the appropriate section for a specific application.
- Beam tracks for ball bearing cars are supplied without holes. On request they can be drilled with custom hole arrangements to suit individual requirements. Contact our sales team for further information.

TYPICAL MATERIAL PROPERTIES

All tracks, unless otherwise stated

Aluminium alloy AL6005-T6

- σ yield = 225 MPa (32.6 ksi)
- σ yield = 270 MPa (39.2 ksi)

RC1225-3.0

Aluminium alloy AL6063-T6

- σ yield = 170 MPa (24.7 ksi)
- σ yield = 215 MPa (31.2 ksi)

RC6190, RC6320

Aluminium alloy AL6061-T6

- σ yield = 240 MPa (34.1 ksi)
- σ yield = 290 MPa (42.1 ksi)

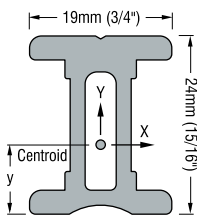

RC6190
 $I_x = 14294\text{mm}^4$ (0.0343in⁴)
 $I_y = 4219\text{mm}^4$ (0.0101in⁴)
 $y = 12.56\text{mm}$ (0.4945")
 CSA = 196mm² (0.3038in²)

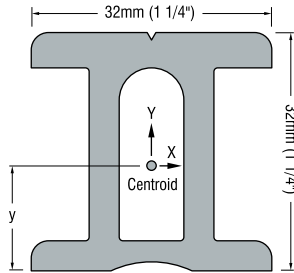

RC6320
 $I_x = 59000\text{mm}^4$ (0.1417in⁴)
 $I_y = 30360\text{mm}^4$ (0.0729in⁴)
 $y = 16.96\text{mm}$ (0.6677")
 CSA = 471mm² (0.7301in²)

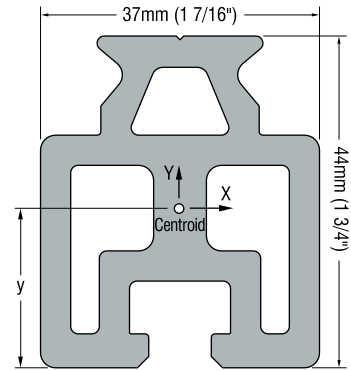

RC1225B-2.0
 $I_x = 133881\text{mm}^4$ (0.3217in⁴)
 $I_y = 98716\text{mm}^4$ (0.2372in⁴)
 $y = 20.2\text{mm}$ (0.7957")
 CSA = 836 mm² (1.2969in²)

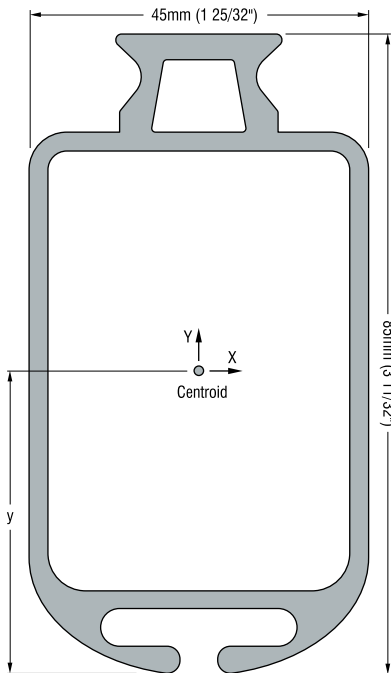

RC1225-3.0
 $I_x = 664730\text{mm}^4$ (1.5970in⁴)
 $I_y = 184248\text{mm}^4$ (0.4427in⁴)
 $y = 42.3\text{mm}$ (1.6654")
 CSA = 768mm² (1.1904in²)

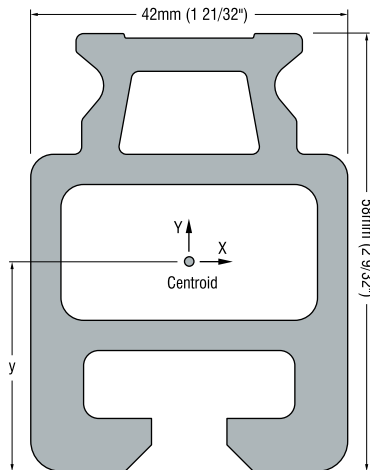

RC1305B-3.0
 $I_x = 338641\text{mm}^4$ (0.8136in⁴)
 $I_y = 202808\text{mm}^4$ (0.4872in⁴)
 $y = 26.9\text{mm}$ (1.0591")
 CSA = 1051mm² (1.6291in²)

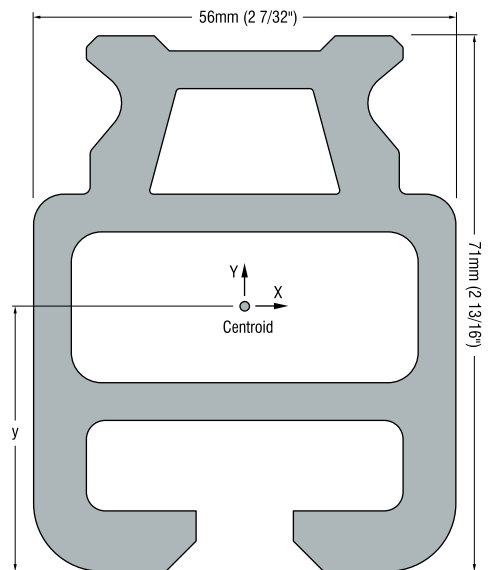

RC1425-3.0
 $I_x = 797749\text{mm}^4$ (1.9166in⁴)
 $I_y = 558530\text{mm}^4$ (1.3419in⁴)
 $y = 34.7\text{mm}$ (1.3611")
 CSA = 1687mm² (2.6149in²)

TRACK BENDING

In certain applications it is advantageous to curve tracks either horizontally ('A' bend) or vertically ('B' bend). Track can be bent to match deck camber, or to ensure that the tension on a purchase system attached to a traveller car remains constant as the car moves along the track.

HORIZONTAL PLANE – 'A' BEND

In situations where cars and fittings are required to rotate around a central pivot point, horizontal 'A' bending of the track will ensure the load applied to the car remains vertical. This results in maximum strength and free rolling ability being maintained by the car. Maintaining this vertical alignment also ensures tension in an attached purchase system remains constant, a feature often sought after in sailboat mainsheet and boom vang traveller systems.

VERTICAL PLANE – 'B' BEND

Traveller tracks can be bent vertically to fulfil certain requirements. They can be top mounted or underhung mounted with either concave or convex track bends.

'B' bends are often required to match the mounting surface to which a track is to be fixed; as when matching deck camber on a sailboat.

'B' bending can also be used to maintain constant tension in a purchase system mounted on a traveller car. This application is very popular on sailboat mainsheet and self-tacking jib systems where the increased load applied to the car during tacking or gybing may affect sail trim or increase rolling friction.

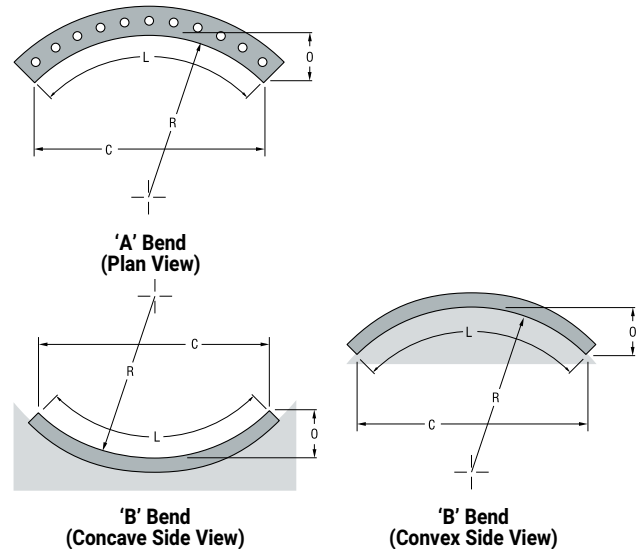

MINIMUM BEND RADIUS

TRAVELLER SERIES	CAR LENGTH mm	MINIMUM HORIZONTAL 'A' BEND RADIUS mm	MINIMUM HORIZONTAL 'B' BEND RADIUS mm	MINIMUM BEND RADIUS		
				CAR LENGTH in	MINIMUM HORIZONTAL 'A' BEND RADIUS in	MINIMUM HORIZONTAL 'B' BEND RADIUS in
BB Series 14	47	1300	800	1 27/32	51 7/32	31 17/32
	50	1400	970	1 31/32	55 1/8	38 7/32
	68	2000	2000	2 11/16	78 13/16	78 13/16
	78	3500	4500	3 1/16	137 29/32	177 5/16
BB Series 19	50	1500	1500	1 31/32	60	27 29/32
	70	2500	3000	2 3/4	98 1/2	118 3/16
	85	3500	4500	3 11/32	137 29/32	177 5/16
	100	5000	5500	3 15/16	197	216 11/16
BB Series 22	75	1500	2000	2 31/32	59 3/32	78 13/16
	125	5000	5000	4 15/16	197	197
	175	9000	13000	6 29/32	354 19/32	512 3/16
	180	9000	13000	7 3/32	354 19/32	512 3/16
BB Series 26	108	2500	2500	4 1/8	98 13/32	98 13/32
	120	4000	4000	4 23/32	157 19/32	157 19/32
	200	8000	8000	7 7/8	315 3/16	315 3/16
	205	9000	9000	2 1/16	354 19/32	354 19/32
	210	9400	9400	8 1/4	370 3/32	370 3/32
BB Series 30	100	2500	2500	3 15/16	98 1/2	98 1/2
	108	2875	2875	4 1/4	113 3/16	113 3/16
	120	4900	4900	4 23/32	192 1/32	192 1/32
	150	8000	8000	5 29/32	315 3/16	315 3/16
	210	12400	12400	8 1/4	488 3/16	488 3/16
	225	16000	16000	8 7/8	630 13/32	630 13/32
	332	22500	22500	13 1/16	885 13/16	885 13/16
I-Track 19	51	400	400*	2	15 3/4	15 3/4
	86	1200	Not suitable	3 3/8	47 1/4	Not suitable
I-Track 32	76	500	500*	3	19 11/16	20
	157	500	Not suitable	6 3/16	19 11/16	Not suitable

Please contact our sales team for minimum bend radius requirements for Series 42 and 55 traveller cars.

* Manufacture of B-Bends for I-track 19 & 32 have length & radius limitations, please contact our sales team with your requirements.

CURVED TRACK SPECIFICATION REQUIREMENTS

Specifications are required for each type of bend, including two critical dimensions (three if possible), and clear drawings where possible.

Critical Dimension Required

Radius	R	and	O	Offset
			OR	
Radius	R	and	L	Length of Track
			OR	
Radius	R	and	C	Chord Length
			OR	
Offset	O	and	C	Chord Length

In many 'B' bend situations, the radius R is not known and it is easiest to specify the curve by C (chord length) and O (offset) values. In these cases, the radius the track is to follow MUST be constant.

It should be noted that:

- Although track bends may appear desirable to provide ideal alignment and avoid angular loads being applied to the car, in a ball bearing system the bend may reduce the load capacity of the system by loading the balls unevenly over the length of the car.
- Light bends can be 'sprung in' during installation, however considerable care must be taken to ensure that the curves are even with no tight spots and that the track is not over-bent (permanently deformed) during installation.
- Not all track types are suited to both types of bends, and some types of tracks cannot be curved at all.
- A minimum track radius is specified for each length of traveller car. This is the tightest curve a car will run around freely. Refer to the recommendations on this page for each track type regarding suitability and minimum radius values.

For best results, track should be ordered pre-bent from Ronstan.

Ordering

- Specify the type of track profile (by product no.)
- Indicate the type of bend required 'A' Bend (horizontal), or 'B' Bend (vertical) Concave or Convex.
- Provide the appropriate dimensional specifications as described above.



© Matic Krašovec / Seascope

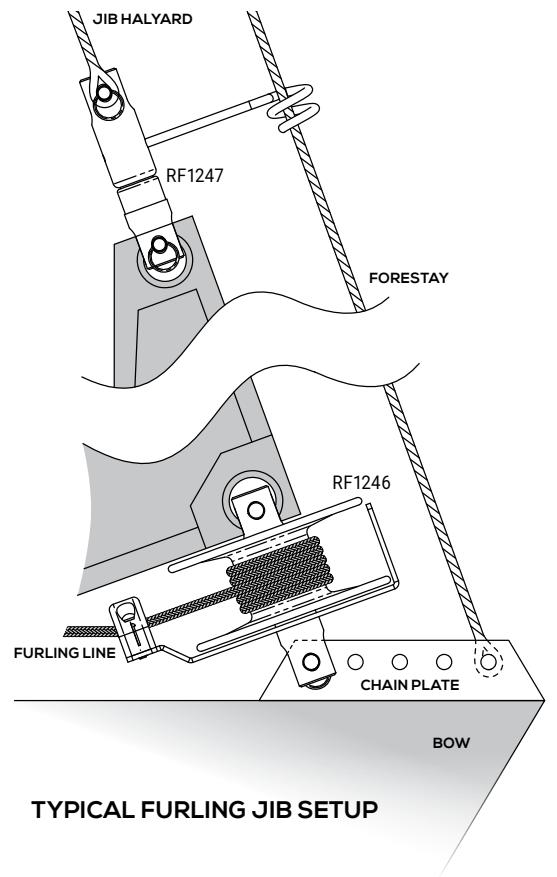

PRODUCT No.	DESCRIPTION	B.L.	WEIGHT	B.L.	WEIGHT
		kg	g	lb	oz
Small Boat Drum Furlers					
RF3	Staunchion block for furling lines 12mm (1/2") maximum rope diameter	-	30	-	1.1
RF76	Jib furler, 65mm (2 1/2") diameter. Enclosed acetal drum with stainless steel ball bearing swivel unit. Overall height 80mm (3 1/8")	1700	155	3740	5.5
RF78B	Fork/Eye swivel, 6.4mm (1/4") diameter pin and 8.2mm (5/16") diameter hole. See page 207 for further details	1700	60	3740	2.1
RF1246	Jib furler, 114mm (4 1/2") diameter. Glass-reinforced nylon drum with stainless steel ball bearing swivel unit and furling line lead-arm. Overall height 114mm (4 1/2")	2600	500	5720	17.6
RF1247	Fork/Fork swivel, incorporating forestay location bar, 7.9mm (5/16") diameter pins. See page 207 for further details	2600	240	5720	8.5

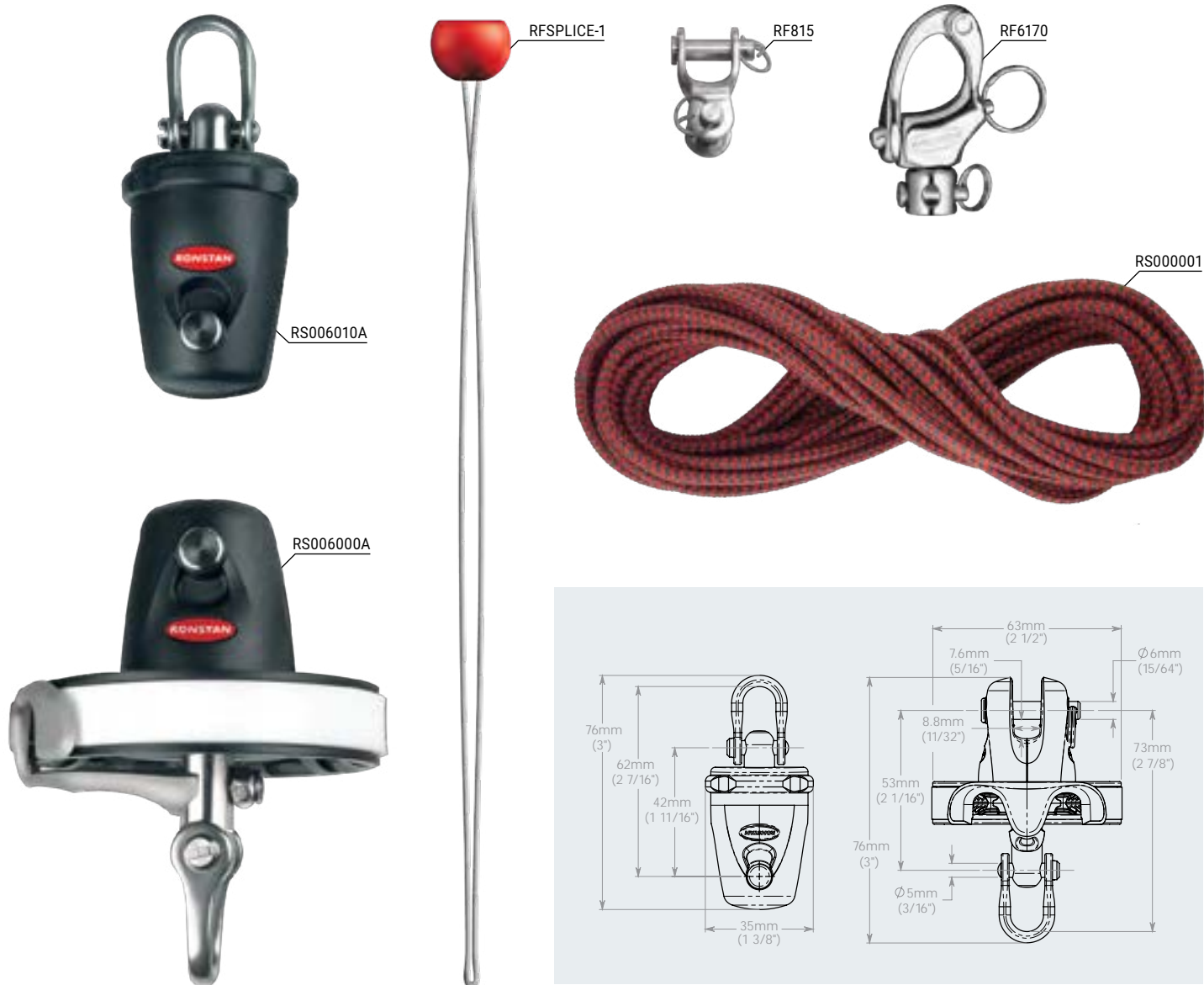

- ✔ Optimised drum diameter for power and furling efficiency, combined with minimum weight.
- ✔ Alloy drum with ribbed rope groove profile for maximum grip on furling line.
- ✔ Furling line self-ejects from drum grip area as sail unfurls for fast, smooth deployment.
- ✔ Free running stainless steel bearings and ball races to minimise friction for high speed furling.

- ✔ Low profile design allows maximum luff length/sail area.
- ✔ The pre-spliced furling line can be shortened if required and respliced using the RFSPLICE-1 splicing needle. See the SUPPORT tab at www.ronstan.com for details.
- ✔ Furling on off-the-beach dinghies, multihulls and sportsboats to 7m (23ft).

- ✔ Low friction PTFE perimeter strip prevents furling line snagging or fouling.
- ✔ Hard anodised aluminium drum for maximum durability.
- ✔ Glass filled, thermoplastic swivel body for minimum weight aloft.
- ✔ Highly polished stainless steel rope guide for low friction and minimal rope wear.

PRODUCT No.	DESCRIPTION	DRUM	SWIVEL	LINE	M.W.L.	B.L.	WEIGHT	DRUM	SWIVEL	LINE	M.W.L.	B.L.	WEIGHT
		DIAM.	DIAM.					DIAM.	DIAM.				
		mm	mm	mm	kg	kg	g	in	in	in	lb	lb	oz
Furler & Top Swivel													
RS006000A	Gennaker furler	63	-	5	500	1300	138	2 1/2	-	3/16	1100	2860	4.9
RS006010A	Top swivel	-	35	-	500	1300	85	-	1 3/8	-	1100	2860	3.0
Accessories													
RF815	Two-way link, 5mm (3/16") pin, suits RS006000						1100	14				2425	0.5
RF6170	Snap shackle adapter, swivelling, 16mm (5/8") eye clearance, suits RS006000				500	1000	49				1100	2200	1.7
RFSPLICE-1	Splicing needle						10						0.4
RS000001	Pre-spliced continuous furling line, 5mm (3/16") diameter x 8m (26ft) loop						135						5.1



Lightweight machined drum



Secure, snag-free connections



Rotation stop accessory



Top swivel with optional lashing pin



Retained, quick release clevis pins



Top-down models



CONTINUOUS LINE FURLERS

REFINED DESIGN, PERFORMANCE & RELIABILITY

Our Continuous Line Furlers put great performance and reliability within the reach of cruising and racing sailors alike.

Advanced drum technology

The range matches drum diameters to load ratings providing the optimum balance between speed and ease of furling. Drums incorporate a machined groove profile and cross-hole geometry to grip the furling line securely. When deploying the sail the continuous furling line self-ejects from the grip zone, remaining stationary for smoother, safer operation with minimum rope wear. A low friction plastic perimeter strip ensures the unloaded furling line can't fall from the drum or become snagged.

Maintenance free bearing system

Furlers and top swivels feature a factory sealed, maintenance free bearing. Roller bearing sets run on hardened races for smooth high load performance.

Easy continuous line installation and removal

The continuous furling line is easily fitted and removed from the furler, so it can be left on deck when the sail and furler are stowed below.

Top-Down models for soft luff sails

Top-down furling provides a new level of simplicity, safety and speed for handling of soft luff sails such as asymmetric spinnakers and gennakers. Cruisers can now store, deploy and retrieve these sails as simply as they would a furling headsail from the safety and convenience of the cockpit. Racers too can benefit from the characteristics of top-down to allow superfast retrieval of code zeros by pre-winding the torsion rope and firing the sheet when ready. Ronstan furlers are available with top-down adapters or in dedicated top-down models with practical accessories such as top swivel lashing pins to provide the perfect solution.

Secure & flexible attachment options

Furlers and top swivels have retained clevis pins and top swivels have a snag-free low profile shackle pin head. Attachment options include quick release pins, high resistance shackles, snap shackles, fairleads and torsion rope thimbles. The furling line guide can be adjusted to suit either 0° or 90° attachment, as required to match the take-off alignment and deck layout.

Rotation stop accessory

A compact rotation stop can be added to compatible models of furlers to avoid inadvertent unfurling of the sail. The rotation stop is simply installed on the underside of the furler and can be locked out when in use, or in when the sail is furled or stowed.

STANDARD FURLING SYSTEMS

- 1 Torsion rope
- 2 Top swivel
- 3 Thimble
- 4 Standard furler
- 5 2:1 or 3:1 fairlead, shackle or snap shackle to padeye
- 6 Neoprene top swivel cover

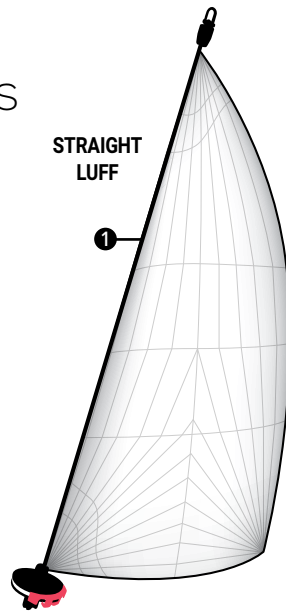
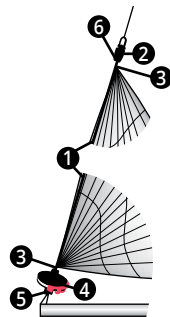

Applications: Sails with a "straight" luff.

For upwind sailing, true wind angles less than 90°.

• Code Zero • Screecher • Staysail

How it works:

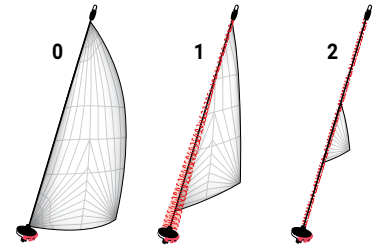

1. Furling drum rotated. Winds sail around torsion rope along full length.

2. Sail continues to furl along full length of torsion rope.

TOP-DOWN FURLING SYSTEMS

- 1 Torsion rope
- 2 Top swivel
- 3 Thimble
- 4 Top-down furler or standard furler with top-down adapter (S200 & S280)
- 5 Integrated swivel ring
- 6 2:1 or 3:1 fairlead, shackle or snap shackle to padeye
- 7 Neoprene top swivel cover

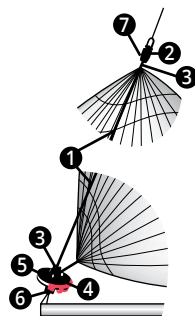

SOFT LUFF
(Positive luff curvature)

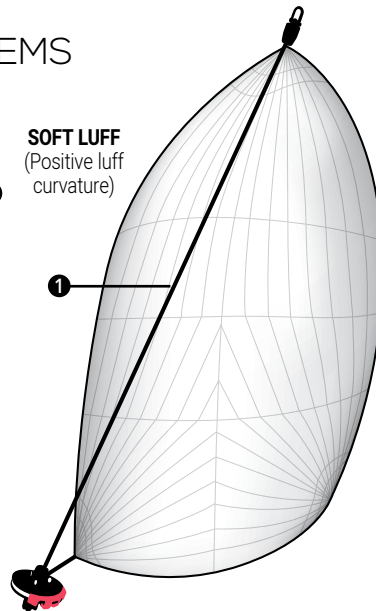

Applications: Sails with a "soft" luff, and full mid-section.

For downwind sailing, true wind angle greater than 90°.

• Code 1-6 • Reacher • Runner • Gennaker

How it works:

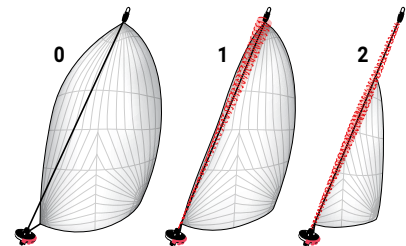

1. Furling drum rotated. Tack remains stationary on 'floating' swivel ring while torsion rope rotates top swivel, commencing to wind sail around torsion rope from top and full mid-section.

2. Sail continues to furl from top down.

SELECTION GUIDE

FURLERS

TYPICAL MAXIMUM BOAT SIZE

SERIES	Code Zero (Standard Furling)			Spinnaker (Top-Down Furling)		
	Monohull LOA	Multihull LOA	Sail Area	Monohull LOA	Multihull LOA	Sail Area
Series 80	9m (30')	8m (26')	40m ² (430ft ²)	10m (33')	8m (26')	75m ² (805ft ²)
Series 120	12m (40')	10m (33')	90m ² (965ft ²)	14m (46')	12m (40')	140m ² (1505ft ²)
Series 160	14m (46')	12m (40')	130m ² (1395ft ²)	16m (53')	14m (46')	200m ² (2150ft ²)
Series 200	18m (60')	15m (50')	270m ² (2900ft ²)	21m (69')	18m (60')	400m ² (4305ft ²)
Series 280	21m (69')	18m (60')	350m ² (3765ft ²)	25m (82')	21m (69')	525m ² (5650ft ²)

ACCESSORIES



SERIES	Neoprene Top Swivel Cover	Snap Shackle	2:1 or 3:1 Fairlead	3:1 Fairlead	Thimble	Shackle	Plunger Stop	Top Swivel Lashing Pin	Quick Release Pin
Series 80	RS208015	RS208020	RS208030	-	RS208040	RS208050	-	RS208080	-
Series 120	RS212015	RS212020	RS212030	-	RS212040	RS212050	RS212070	RS212080	RS212090
Series 160	RS216015	RS216020	RS216030	-	RS216040	RS216050	RS216070	RS216080	RS216090
Series 200	RS220015	-	-	RS220030	RS220040	RS020050	RS216070	-	-
Series 280	RS228015	-	-	RS228030	RS228040	RS020050R	-	-	-

TOP SWIVELS



TOP-DOWN FURLERS



STANDARD FURLERS



- ✔ Series 80, 120 & 160 furlers include a shackle on the underside of the furler.
- ✔ Top swivels feature snag-free low profile shackle pin heads.
- ✔ Quick furling line installation and removal requires no tools.

- ✔ Maintenance free, factory sealed main bearing systems.
- ✔ Dimensioned technical drawings and user instructions can be found under the SUPPORT tab at www.ronstan.com.
- ✔ Grade 17-4PH forged stainless steel shackles.

- ✔ Grade 316 stainless steel fasteners.
- ✔ Grade 2205 stainless steel shaft and pins.
- ✔ Aluminium drum, swivel jaws & line guide.
- ✔ HDPE perimeter strip.
- ✔ Torlon® ball bearings (top-down swivel ring).

PRODUCT No.	DESCRIPTION	LINE	M.W.L.	B.L.	WEIGHT	LINE	M.W.L.	B.L.	WEIGHT
		mm	kg	kg	g	in	lb	lb	oz
Top Swivels									
RS208010	Series 80, top swivel	-	950	1900	134	-	2090	4190	4.7
RS212010	Series 120, top swivel	-	1800	3600	204	-	3970	7940	7.2
RS216010	Series 160, top swivel	-	3000	6000	382	-	6610	13230	13.5
Top-Down Furlers									
RS208100	Series 80, top-down furler	8	475*1 / 950*2	1900	266	5/16	1045*1 / 2090*2	4190	9.4
RS212100	Series 120, top-down furler	8	900*1 / 1800*2	3600	546	5/16	1980*1 / 3970*2	7940	19.3
RS216100	Series 160, top-down furler	10	1500*1 / 3000*2	6000	916	3/8	3300*1 / 6610*2	13230	32.3
Standard Furlers									
RS208000	Series 80, standard furler	8	950	1900	228	5/16	2090	4190	8.0
RS212000	Series 120, standard furler	8	1800	3600	383	5/16	3970	7940	13.5
RS216000	Series 160, standard furler	10	3000	6000	790	3/8	6610	13230	27.9

*1 MWL on swivel ring (tack load).

*2 MWL on clevis pins (torsion line + tack load).

TOP SWIVELS

TOP-DOWN ADAPTERS

STANDARD FURLERS

- ✔ Top swivel fork/fork configuration for snag-free operation and direct halyard soft eye attachment.
- ✔ Connection post of Series 200 & 280 furlers are compatible with shackle or fairlead attachment.

- ✔ Fast pins on furlers and top swivels facilitate easy changeover of sails sharing a common furler set.
- ✔ Dimensioned technical drawings and user instructions can be found under the SUPPORT tab at www.ronstan.com.

- ⚙ Grade 316 stainless steel fasteners.
- ⚙ Grade 2205 stainless steel shaft and pins.
- ⚙ Aluminium drum, swivel jaws & line guide.
- ⚙ PTFE perimeter strip.
- ⚙ Torlon® ball bearings (top-down adapter swivel ring).

PRODUCT No.	DESCRIPTION	LINE mm	M.W.L. kg	B.L. kg	WEIGHT g	LINE in	M.W.L. lb	B.L. lb	WEIGHT oz
Top Swivels									
RS220010	Series 200, top swivel	-	5000	10000	748	-	11020	22040	26.4
RS228010	Series 280, top swivel	-	8000	16000	1700	-	17630	35270	60.1
Top-Down Adapters									
RS220060	Series 200, top-down adapter	-	3000*1 / 5000*2	10000	966	-	6610*1 / 11020*2	22040	34.0
RS228060	Series 280, top-down adapter	-	5000*1 / 8000*2	16000	1950	-	11020*1 / 17630*2	35270	68.9
Standard Furlers									
RS220000	Series 200, standard furler	10	5000	10000	1730	3/8	11020	22040	61.0
RS228000	Series 280, standard furler	12	8000	16000	3250	1/2	17630	35270	114.6

*1 MWL on swivel ring (tack load).

*2 MWL on clevis pins (torsion line + tack load).



NEOPRENE TOP SWIVEL COVER



SNAP SHACKLES



2:1 OR 3:1 FAIRLEADS



3:1 FAIRLEADS



TORSION ROPE THIMBLES



SHACKLES



FURLER ROTATION STOPS



QUICK RELEASE PINS



TOP SWIVEL LASHING PINS

- ✔ 2:1 fairlead can be used on furler or top swivel.
- ✔ 3:1 fairlead incorporates a fast pin for quick and easy removal from furler - where 3:1 tack line remains on bowsprit when sail and furler are removed.

- ✔ Furler rotation stop prevents accidental unfurling.
- ✔ Top swivel lashing pin allows for closer sail attachment at head, improving furling for top-down systems.

- ✔ Grade 6061-T6 aluminium thimbles, and 3:1 fairlead.
- ✔ UV resistant neoprene top swivel covers.
- ✔ Grade 2205 stainless steel quick release pins.
- ✔ Grade 17-4PH stainless steel forged HR shackles.

PRODUCT No.	DESCRIPTION	M.W.L. kg	B.L. kg	WEIGHT g	M.W.L. lb	B.L. lb	WEIGHT oz
Neoprene Top Swivel Covers							
RS208015	Neoprene swivel cover, suits RS208010	-	-	7	-	-	0.2
RS212015	Neoprene swivel cover, suits RS212010	-	-	10	-	-	0.4
RS216015	Neoprene swivel cover, suits RS216010	-	-	15	-	-	0.5
RS220015	Neoprene swivel cover, suits RS220010 (two required per swivel)	-	-	18	-	-	0.6
RS228015	Neoprene swivel cover, suits RS228010 (two required per swivel)	-	-	20	-	-	0.9
Snap Shackles							
RS208020	Snap shackle, suits RS208000 & RS208100	960	2000	54	2120	4410	1.9
RS212020	Snap shackle, suits RS212000 & RS212100	1280	3850	130	2820	8490	4.6
RS216020	Snap shackle, suits RS216000 & RS216100	2800	7000	257	6170	15430	9.1
Fairleads							
RS208030	2:1 or 3:1 fairlead, suits RS208000 & RS208100	1040	2300	44	2290	5070	1.6
RS212030	2:1 or 3:1 fairlead, suits RS212000 & RS212100	1760	4100	96	3880	9040	3.4
RS216030	2:1 or 3:1 fairlead, suits RS216000 & RS216100	2640	6000	186	5820	13230	6.6
RS220030	3:1 fairlead, suits RS220000	5000	10000	350	11020	22040	12.3
RS228030	3:1 fairlead, suits RS228000	8000	16000	800	17630	35270	28.2
Torsion Rope Thimbles							
RS208040	Torsion rope thimble, suits RS208000, RS208100 & RS208010	-	-	8	-	-	0.3
RS212040	Torsion rope thimble, suits RS212000, RS212100 & RS212010	-	-	23	-	-	0.8
RS216040	Torsion rope thimble, suits RS216000, RS216100 & RS216010	-	-	53	-	-	1.9
RS220040	Torsion rope thimble, suits RS220000, RS220010 & RS220060	-	-	65	-	-	2.3
RS228040	Torsion rope thimble, suits RS228000, RS228010 & RS228060	-	-	164	-	-	5.8
Shackles							
RS208050	Shackle, 6mm (1/4") pin diameter, suits RS208000 & RS208100	-	1950	26	-	4300	0.9
RS212050	HR shackle, 8mm (5/16") pin diameter, suits RS212000 & RS212100	-	4400	55	-	9700	1.9
RS216050	HR shackle, 10mm (13/32") pin diameter, suits RS216000 & RS216100	-	7500	97	-	16500	3.4
RS020050*	HR shackle, 12mm (15/32") pin diameter, suits RS220000	-	10000	237	-	22000	8.4
RS020050R*	HR shackle, 16mm (5/8") pin diameter, suits RS228000	-	19000	470	-	41800	16.6
Furler Rotation Stops							
RS212070	Furler rotation stop, suits RS212000 & RS212100	-	-	10	-	-	0.3
RS216070	Furler rotation stop, suits RS216000, RS216100 & RS220000	-	-	18	-	-	0.6
Top Swivel Lashing Pins							
RS208080	Top swivel lashing pin, 7mm (9/32"), suits RS208010	950	1900	29	2090	4190	1.0
RS212080	Top swivel lashing pin, 8mm (5/16"), suits RS212010	1800	3600	48	3970	7940	1.7
RS216080	Top swivel lashing pin, 10mm (13/32"), suits RS216010	3000	6000	90	6610	13230	2.3
Quick Release Pins							
RS212090	Quick release pin, 8mm (5/16") diameter, suits RS212000, RS212100 & RS212010	1800	3600	14	3970	7940	0.5
RS216090	Quick release pin, 10mm (13/32") diameter, suits RS216000, RS216100 & RS216010	3000	6000	26	6610	13230	0.9

* RS020050 & RS020050R have a coined and drilled head shackle pin



Captive ball bearings

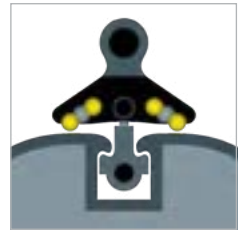

Use existing mast luff groove



Quick release batten car models



Flexible solutions



Ball joint articulation

BALLSLIDE™ BATTEN CAR SYSTEMS

QUICK, EASY AND RELIABLE

Ronstan's Ballslide™ system makes raising and lowering the mainsail quick and easy. Recirculating captive ball bearings ensure free running performance, and since the cars use the existing luff groove of the mast there is no need to install a track.

Compatibility

With a complete range of car profiles and feet there is a Ballslide™ solution for most available mast profiles and luff groove shapes on boats up to 18m (60ft). See page 144 for car and feet details. Selection tables and specification sheets can be downloaded at www.ronstan.com.

Performance

BB Ballslide™ cars run on twin races of recirculating ball bearings specifically designed and oriented for compression loads. Hoisting and dropping the mainsail has never been easier! Ball joint links for batten receptacles and quick release pins for intermediate cars are configured to minimise the distance from mast to mainsail luff.

Convenience

Ballslide™ cars are easily loaded, and just as easily removed from the luff groove of the mast. Larger boats using the Series 8 system may opt for cars with quick release ball joints for the batten receptacles to facilitate initial setup or removal of larger mainsails.

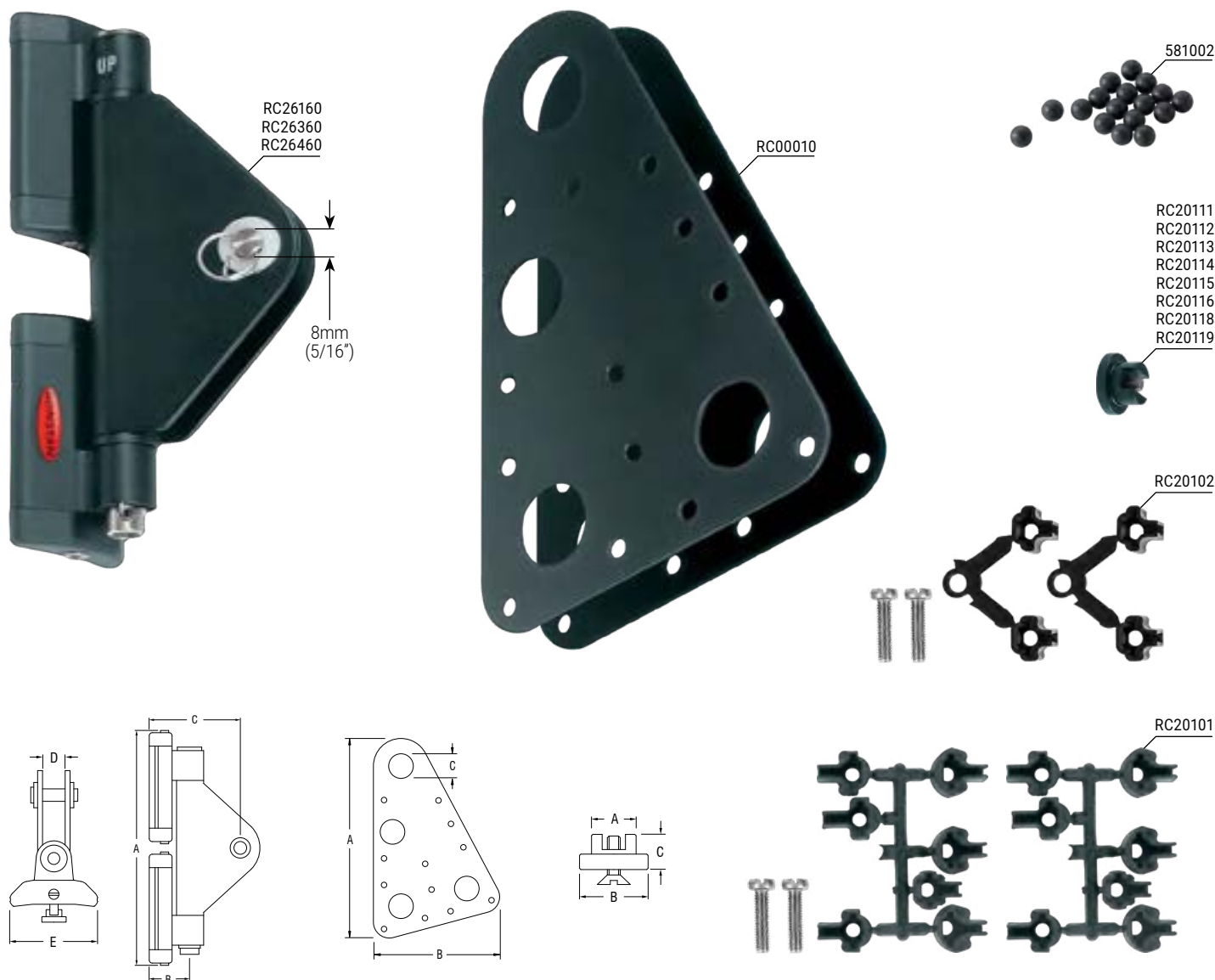

☑ Refer to page 144 and the SUPPORT tab at www.ronstan.com for additional details regarding cars and feet installation information.

📄 Refer to the SUPPORT tab at www.ronstan.com for assistance in specifying system requirements and schematic diagrams.

PRODUCT No.	DESCRIPTION	A	B	C	D	E	WEIGHT	A	B	C	D	E	WEIGHT
		mm	mm	mm	mm	mm	g	in	in	in	in	in	oz
Series 6 BB													
RC00010	Headboard plates (pair)	188.0	119	23.0	-	-	173	7 13/32	4 11/16	29/32	-	-	6.1
RC20101	Replacement Ballslide™ feet kit, suits RC261xx cars, includes one pair of each size narrow feet N1-N7	-	-	-	-	-	1	-	-	-	-	-	0.1
RC20102	Replacement Ballslide™ feet kit, suits RC263xx cars, includes one pair of each size narrow feet N8 & N9	-	-	-	-	-	1	-	-	-	-	-	0.1
RC20111	Ballslide™ wide feet (pair), with s/s screws & washers, suits RC264xx cars	13.0	20	10.3	-	-	14	1/2	25/32	13/32	-	-	0.5
RC20112	Ballslide™ wide feet (pair), with s/s screws & washers, suits RC264xx cars	13.7	20	11.4	-	-	14	17/32	25/32	7/16	-	-	0.5
RC20113	Ballslide™ wide feet (pair), with s/s screws & washers, suits RC264xx cars	13.7	20	11.0	-	-	14	17/32	25/32	7/16	-	-	0.5
RC20114	Ballslide™ wide feet (pair), with s/s screws & washers, suits RC264xx cars	13.7	20	11.5	-	-	14	17/32	25/32	7/16	-	-	0.5
RC20115	Ballslide™ wide feet (pair), with s/s screws & washers, suits RC264xx cars	12.8	20	10.5	-	-	14	1/2	25/32	13/32	-	-	0.5
RC20116	Ballslide™ wide feet (pair), with s/s screws & washers, suits RC264xx cars	8.8	16	6.6	-	-	6	11/32	5/8	1/4	-	-	0.2
RC20118	Ballslide™ wide feet (pair), with s/s screws & washers, suits RC264xx cars	8.8	16	7.6	-	-	6	11/32	5/8	5/16	-	-	0.2
RC20119	Ballslide™ feet (pair), with s/s screws & washers, suits RC264xx cars	9.8	20	9.9	-	-	10	3/8	25/32	3/8	-	-	0.3
RC26160	Headboard car, incl. RC20101 narrow feet set	160.0	23	62.0	12	41	280	6 5/16	29/32	2 7/16	15/32	1 5/8	9.9
RC26360	Headboard car, incl. RC20102 narrow feet set	160.0	23	62.0	12	41	280	6 5/16	29/32	2 7/16	15/32	1 5/8	9.9
RC26460	Headboard car, suits wide feet (not included)	160.0	23	62.0	12	41	280	6 5/16	29/32	2 7/16	15/32	1 5/8	9.9
Spare Parts													
581002	Ball bearing, acetal, 6.35mm (1/4") diameter	-	-	-	-	-	1	-	-	-	-	-	0.1



© Armare

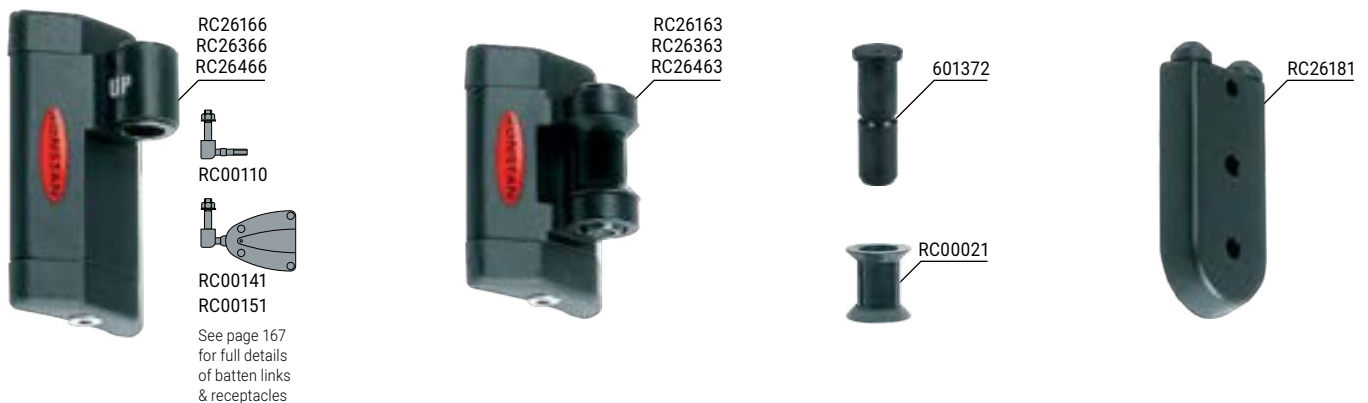

See page 167
for full details
of batten links
& receptacles

☑ Refer to page 144 and the SUPPORT tab at www.ronstan.com for additional details regarding cars and feet.

⚙ Refer to the SUPPORT tab at www.ronstan.com for assistance in specifying system requirements and schematic diagrams.

⚙ Monohulls to 12m (40ft) or sail area 38m² (409ft²).

⚙ Multihulls to 9m (30ft) or sail area 30m² (323ft²).

PRODUCT No.	DESCRIPTION	A	B	C	D	E	WEIGHT	A	B	C	D	E	WEIGHT
		mm	mm	mm	mm	mm	g	in	in	in	in	in	oz
Series 6 													
RC26163	Intermediate car, incl. RC20101 narrow feet set	55	23	31	18	41	50	2 5/32	29/32	1 7/32	23/32	1 5/8	1.8
RC26166	Batten car, incl. RC20101 narrow feet set	68	23	31	-	41	65	2 11/16	29/32	1 7/32	-	1 5/8	2.3
RC26181	End stop, plastic	68	33	-	-	-	11	2 11/16	1 5/16	-	-	-	0.4
RC26363	Intermediate car, incl. RC20102 narrow feet set	55	23	31	18	41	50	2 5/32	29/32	1 7/32	23/32	1 5/8	1.8
RC26366	Batten car, incl. RC20102 narrow feet set	68	23	31	-	41	65	2 11/16	29/32	1 7/32	-	1 5/8	2.3
RC26463	Intermediate car, suits wide feet (not included)	55	23	31	18	41	50	2 5/32	29/32	1 7/32	23/32	1 5/8	1.8
RC26466	Batten car, suits wide feet (not included)	68	23	31	-	41	65	2 11/16	29/32	1 7/32	-	1 5/8	2.3
Spare Parts													
601372	Replacement pin for RC26163, RC26363, RC26463	-	-	-	-	-	5	-	-	-	-	-	0.2
RC00021	Replacement bush for RC26163, RC26363, RC26463	-	-	-	-	-	1	-	-	-	-	-	0.1



- ☑ Refer to page 144 and the SUPPORT tab at www.ronstan.com for additional details regarding cars and feet.
- 📄 Refer to the SUPPORT tab at www.ronstan.com for assistance in specifying system requirements and schematic diagrams.

PRODUCT No.	DESCRIPTION	A mm	B mm	C mm	D mm	E mm	WEIGHT g	A in	B in	C in	D in	E in	WEIGHT oz
Series 8													
RC00010	Headboard plates (pair)	188	119	23	-	-	173	7 13/32	4 11/16	29/32	-	-	6.1
RC20101	Replacement Ballslide™ feet kit, suits RC281xx cars, includes one pair of each size narrow feet N1-N7	-	-	-	-	-	1	-	-	-	-	-	0.1
RC20130	Ballslide™ wide feet (pair), suits RC284xx cars	13.3	24.0	11.4	-	-	22	17/32	15/16	7/16	-	-	0.8
RC20131	Ballslide™ wide feet (pair), suits RC284xx cars	11.6	23.0	11.8	-	-	20	15/32	29/32	15/32	-	-	0.7
RC20135	Ballslide™ wide feet (pair), suits RC284xx cars	12.5	24.0	10.5	-	-	22	1/2	15/16	13/32	-	-	0.8
RC28160	Headboard car, incl. RC20101 narrow feet set	214	30	75	16.5	51	520	8 7/16	1 3/16	2 15/16	2 1/32	2	18.3
RC28161	Headboard car, incl. RC20101 narrow feet set	290	30	75	16.5	51	750	11 7/16	1 3/16	2 15/16	2 1/32	2	26.5
RC28460	Headboard car, suits wide feet (not included)	214	30	75	16.5	51	520	8 7/16	1 3/16	2 15/16	2 1/32	2	18.3
RC28461	Headboard car, suits wide feet (not included)	290	30	75	16.5	51	750	11 7/16	1 3/16	2 15/16	2 1/32	2	26.5
Spare Parts													
581004	Ball bearing, acetal, 8.00mm (0.315") diameter	-	-	-	-	-	1	-	-	-	-	-	0.1

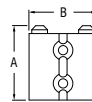
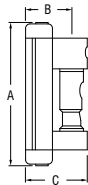
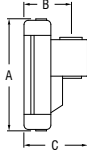
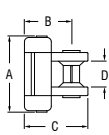
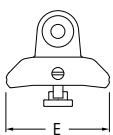

- ✔ Refer to page 144 and the SUPPORT tab at www.ronstan.com for additional details regarding cars and feet.
- ⬆ Refer to the SUPPORT tab at www.ronstan.com for assistance in specifying system requirements and schematic diagrams.

- ⬆ Long cars: Monohulls to 18m (60ft) or sail area 60m² (646ft²).
- ⬆ Long cars: Multihulls to 13m (43ft) or sail area 48m² (517ft²).

- ⬆ Short cars: Monohulls to 16m (53ft) or sail area 53m² (570ft²).
- ⬆ Short cars: Multihulls to 11m (36ft) or sail area 42m² (452ft²).

PRODUCT No.	DESCRIPTION	A	B	C	D	E	WEIGHT	A	B	C	D	E	WEIGHT
		mm	mm	mm	mm	mm	g	in	in	in	in	in	oz
Series 8 													
RC28163	Intermediate car, incl. RC20101 narrow feet set	76.0	30.0	37.0	18	51	115	3	13/16	115/32	23/32	2	4.1
RC28166	Batten car, incl. RC20101 narrow feet set	92.0	30.0	37.0	-	51	140	3 5/8	13/16	115/32	-	2	4.9
RC28169	Quick release batten car, incl. RC20101 narrow feet set	105.0	30.0	37.0	-	51	220	4 1/8	13/16	115/32	-	2	7.8
RC28181	End stop	54.0	45.0	-	-	-	35	2 1/8	1 25/32	-	-	-	1.2
RC28463	Intermediate car, suits wide feet (not included)	76.0	30.0	37.0	18	51	115	3	13/16	115/32	23/32	2	4.1
RC28466	Batten car, suits wide feet (not included)	92.0	30.0	37.0	-	51	140	3 5/8	13/16	115/32	-	2	4.9
RC28469	Quick release batten car, suits wide feet (not included)	105.0	30.0	37.0	-	51	220	4 1/8	13/16	115/32	-	2	7.8
Spare Parts													
601372	Replacement pin for RC28163, RC28463	-	-	-	-	-	5	-	-	-	-	-	0.2
RC00021	Replacement bush for RC28163, RC28463	-	-	-	-	-	1	-	-	-	-	-	0.1

BALLSLIDE™ SYSTEM CAR/FOOT IDENTIFICATION & REPLACEMENT PARTS

	NARROW FOOT CARS		WIDE FOOT CARS																																																																
	<p>Series 6 - 41mm (1 5/8") wide Series 8 - 51mm (2") wide</p>		<p>Series 6 - 41mm (1 5/8") wide Series 8 - 51mm (2") wide</p>																																																																
SERIES 6	RC261XX Includes 2 x foot sets (N1 to N7), and 2 x screws.	RC263XX Includes 2 x foot sets (N8 & N9), and 2 x screws.	RC264XX Feet not included. Order separately, 1 pair required per car - see below.																																																																
REPLACEMENT FOOT SET	<p>RC20101 Includes 2 x foot sets, and 2 x screws.</p>	<p>RC20102 Includes 2 x foot sets, and 2 x screws.</p>	<p>Order separately. Includes washer & screw.</p> <table border="1"> <thead> <tr> <th>Foot PRODUCT No.</th> <th>A mm</th> <th>B mm</th> <th>C mm</th> <th>A in</th> <th>B in</th> <th>C in</th> </tr> </thead> <tbody> <tr><td>RC20111</td><td>13.0</td><td>20.0</td><td>10.4</td><td>1/2</td><td>25/32</td><td>13/32</td></tr> <tr><td>RC20112</td><td>13.7</td><td>20.0</td><td>11.4</td><td>17/32</td><td>25/32</td><td>7/16</td></tr> <tr><td>RC20113</td><td>13.7</td><td>20.0</td><td>11.0</td><td>17/32</td><td>25/32</td><td>7/16</td></tr> <tr><td>RC20114</td><td>13.7</td><td>20.0</td><td>11.5</td><td>17/32</td><td>25/32</td><td>7/16</td></tr> <tr><td>RC20115</td><td>12.8</td><td>20.0</td><td>10.5</td><td>1/2</td><td>25/32</td><td>13/32</td></tr> <tr><td>RC20116</td><td>8.8</td><td>16.0</td><td>6.6</td><td>11/32</td><td>5/8</td><td>1/4</td></tr> <tr><td>RC20118</td><td>8.8</td><td>16.0</td><td>7.6</td><td>11/32</td><td>5/8</td><td>5/16</td></tr> <tr><td>RC20119</td><td>9.8</td><td>20.0</td><td>10.0</td><td>12/32</td><td>25/32</td><td>13/32</td></tr> </tbody> </table>		Foot PRODUCT No.	A mm	B mm	C mm	A in	B in	C in	RC20111	13.0	20.0	10.4	1/2	25/32	13/32	RC20112	13.7	20.0	11.4	17/32	25/32	7/16	RC20113	13.7	20.0	11.0	17/32	25/32	7/16	RC20114	13.7	20.0	11.5	17/32	25/32	7/16	RC20115	12.8	20.0	10.5	1/2	25/32	13/32	RC20116	8.8	16.0	6.6	11/32	5/8	1/4	RC20118	8.8	16.0	7.6	11/32	5/8	5/16	RC20119	9.8	20.0	10.0	12/32	25/32	13/32
Foot PRODUCT No.	A mm	B mm	C mm	A in	B in	C in																																																													
RC20111	13.0	20.0	10.4	1/2	25/32	13/32																																																													
RC20112	13.7	20.0	11.4	17/32	25/32	7/16																																																													
RC20113	13.7	20.0	11.0	17/32	25/32	7/16																																																													
RC20114	13.7	20.0	11.5	17/32	25/32	7/16																																																													
RC20115	12.8	20.0	10.5	1/2	25/32	13/32																																																													
RC20116	8.8	16.0	6.6	11/32	5/8	1/4																																																													
RC20118	8.8	16.0	7.6	11/32	5/8	5/16																																																													
RC20119	9.8	20.0	10.0	12/32	25/32	13/32																																																													
REPLACEMENT BALL	581002 6.35mm (1/4") diameter	581002 6.35mm (0.25in) diameter	581002 6.35mm (0.25in) diameter																																																																
SERIES 8	RC281XX Includes 2 x foot sets (N1 to N7), and 2 x screws.		RC284XX Feet not included. Order separately, 1 pair required per car - see below.																																																																
REPLACEMENT FOOT SET	<p>RC20101 Includes 2 x foot sets, and 2 x screws.</p>		<p>Order separately. Includes washer & screw.</p> <table border="1"> <thead> <tr> <th>Foot PRODUCT No.</th> <th>A mm</th> <th>B mm</th> <th>C mm</th> <th>A in</th> <th>B in</th> <th>C in</th> </tr> </thead> <tbody> <tr><td>RC20130</td><td>13.3</td><td>24.0</td><td>11.4</td><td>17/32</td><td>15/16</td><td>7/16</td></tr> <tr><td>RC20131</td><td>11.6</td><td>23.0</td><td>11.8</td><td>15/32</td><td>29/32</td><td>15/32</td></tr> <tr><td>RC20135</td><td>12.5</td><td>24.0</td><td>10.5</td><td>1/2</td><td>15/16</td><td>13/32</td></tr> </tbody> </table>		Foot PRODUCT No.	A mm	B mm	C mm	A in	B in	C in	RC20130	13.3	24.0	11.4	17/32	15/16	7/16	RC20131	11.6	23.0	11.8	15/32	29/32	15/32	RC20135	12.5	24.0	10.5	1/2	15/16	13/32																																			
Foot PRODUCT No.	A mm	B mm	C mm	A in	B in	C in																																																													
RC20130	13.3	24.0	11.4	17/32	15/16	7/16																																																													
RC20131	11.6	23.0	11.8	15/32	29/32	15/32																																																													
RC20135	12.5	24.0	10.5	1/2	15/16	13/32																																																													
REPLACEMENT BALL	581004 8.00mm (0.315in) diameter		581004 8.00mm (0.315in) diameter																																																																

TRACK & CAR SYSTEM TRACK MOUNTING SLUGS & FIXING PLATES

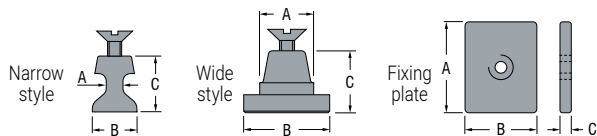

PRODUCT No.	BATTEN TRACK SUITED	STYLE	FASTENING	A mm	B mm	C mm	A in	B in	C in
RC00310*	Series 19	Narrow	M5 countersunk (included)	3.7	9.4	13.5	5/32	3/8	17/32
RC00312	Series 19	Narrow	M5 countersunk (included)	2.8	7.6	12.6	1/8	5/16	1/2
RC00315*	Series 19	Narrow	M5 countersunk (included)	4.6	12.7	16.0	3/16	1/2	5/8
RC00316	Series 19	Narrow	M5 countersunk (included)	3.6	11.0	15.0	5/32	7/16	19/32
RC00321	Series 19	Wide	M5 countersunk (included)	11.8	19.9	13.0	15/32	25/32	1/2
RC00322	Series 19	Wide	M5 countersunk (included)	13.5	21.0	13.0	15/32	27/32	1/2
RC00323	Series 19	Wide	M5 countersunk (included)	8.1	15.0	13.5	5/16	19/32	17/32
RC00370*	Series 19	Fixing plate	M5 countersunk (not included)	25.0	20.0	5.0	1	25/32	3/16
RC00332	Series 22, 26	Narrow	M6 countersunk (included)	3.5	8.3	16.1	1/8	5/16	5/8
RC00333*	Series 22, 26	Narrow	M6 countersunk (included)	4.6	13.0	18.0	3/16	1/2	23/32
RC00341	Series 22, 26	Wide	M6 countersunk (included)	13.6	21.0	15.5	17/32	27/32	5/8
RC00343	Series 22, 26	Wide	M6 countersunk (included)	11.8	19.8	15.5	15/32	25/32	5/8
RC00380*	Series 22, 26	Fixing plate	M6 countersunk (not included)	25.0	20.0	5.0	1	3/4	3/16
RC00360*	Series 30	Wide	M8 countersunk (included)	12.6	22.9	18.0	1/2	29/32	23/32

* Most commonly used

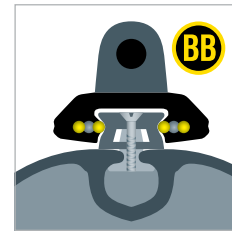

Ball Bearing systems



Captive Ball systems



Quick release batten car models



Luff groove tracks for sail flexibility



Track mounting slugs

TRACK & CAR BATTEN CAR SYSTEMS

STRENGTH & SIMPLICITY

Sailing professionals around the world choose Ronstan batten systems for superior and innovative features combined with race-proven performance and reliability. With 7 track sizes in the standard product range, there is a system with the right specifications for every boat and sail plan.

Flexible solutions

BB Ball Bearing cars run on twin races of recirculating ball bearings that engage with the track profile for excellent all round performance, even when reefing while sailing off the wind.

CB Captive Ball cars use a combination of captive recirculating ball bearings running on the face of the track for compression loads, and sliderods to provide extra strength for high static loads. All bearings are captive, allowing for easy installation and removal.

Luff groove tracks are compatible with 'soft luff' and fully battened mainsails, making it easy to change between the two. They may be bonded to carbon masts with special adhesives.

Quick release cars make the job easier when the sail needs to be removed for changeover, repair or stowage.

Ball joint articulation

A stainless steel ball joint link between the car and the batten receptacle provides movement in all directions with a minimum of 105° (112° for ball bearing cars) either side of centre. Ball joint links are available to suit Ronstan batten receptacles and most other types.

Installation options

Installation can be greatly simplified for Series 19 through Series 30 by the use of threaded slugs that locate in the existing luff groove of the mast, avoiding the need to drill and tap holes for fasteners and other complications. Slugs are self-locating and allow for track installation without having to remove the mast from the boat. See page 144 for track mounting slug details.

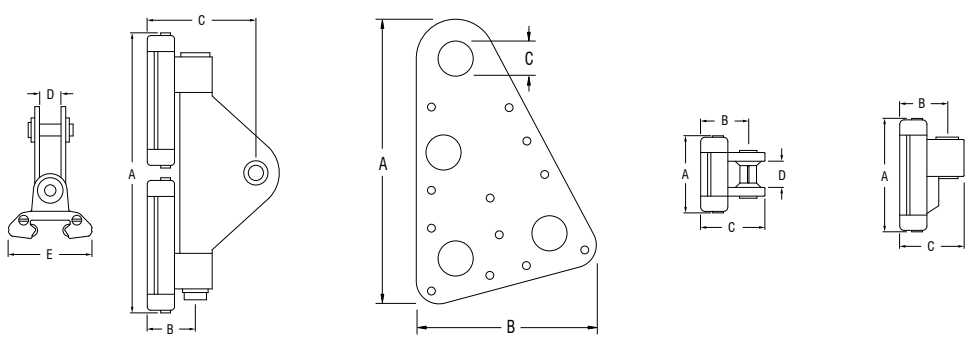
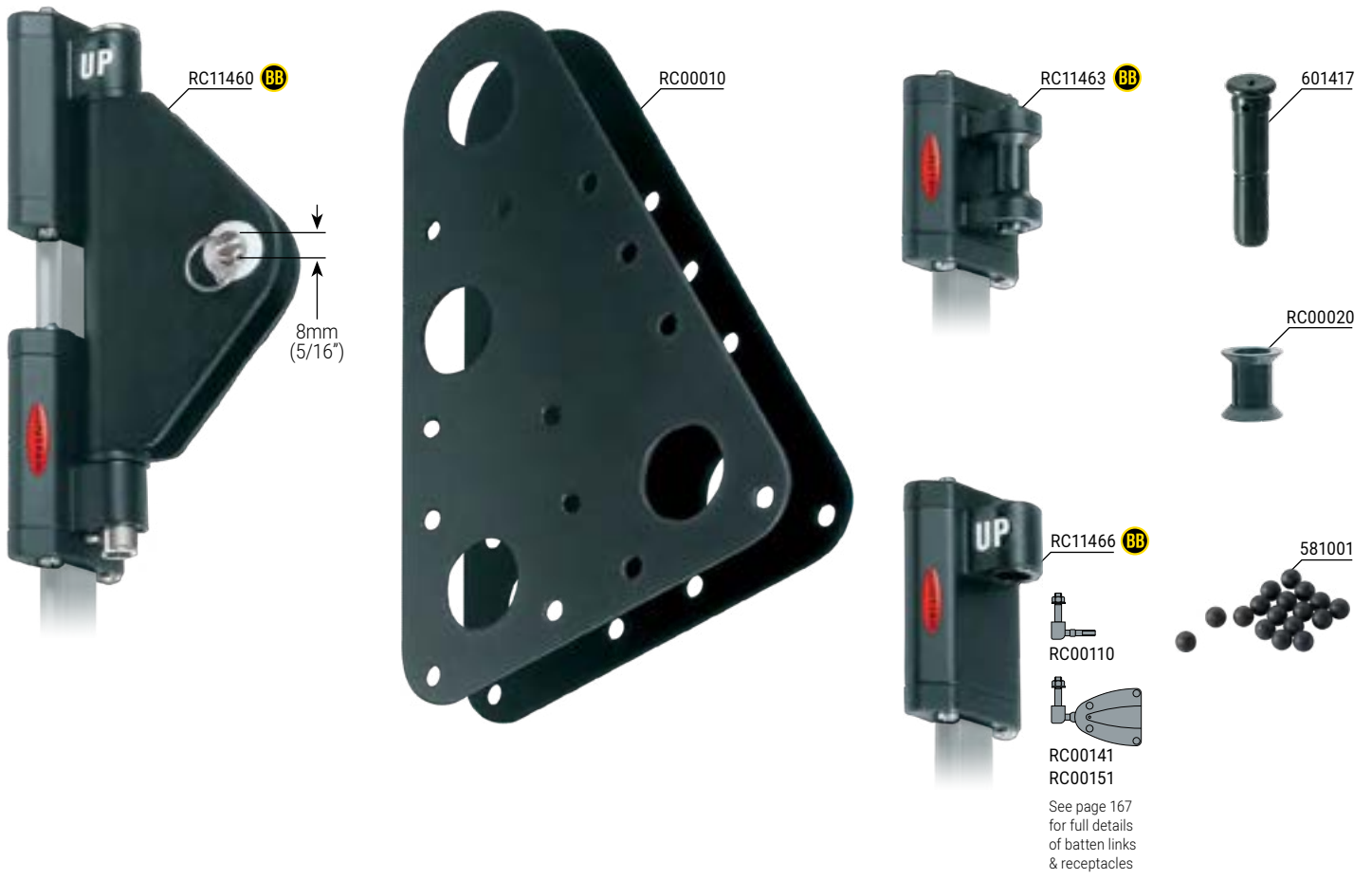

⬆ Monohulls to 12m (40ft) or sail area 38m² (409ft²).
 ⬆ Multihulls to 9m (30ft) or sail area 30m² (323ft²).

PRODUCT No.	DESCRIPTION	A	B	C	D	E	WEIGHT	A	B	C	D	E	WEIGHT
		mm	mm	mm	mm	mm	g	in	in	in	in	in	oz
Series 14 BB													
RC00010	Headboard plates (pair)	188	119	23	-	-	173	7 13/32	4 11/16	29/32	-	-	6.1
RC11460	Headboard car	155	22	60	12.5	41	240	6 3/32	7/8	2 3/8	1/2	1 5/8	8.5
RC11463	Intermediate car	54	22	30	18.0	41	44	2 1/8	7/8	1 3/16	23/32	1 5/8	1.6
RC11466	Batten car	66	22	30	-	41	57	2 19/32	7/8	1 3/16	-	1 5/8	2.0

Spare Parts

581001	Ball bearing, acetal, 5.00mm (0.197") diameter	-	-	-	-	-	1	-	-	-	-	-	0.1
601417	Replacement pin for RC11463	-	-	-	-	-	4	-	-	-	-	-	0.1
RC00020	Replacement bush for RC11463	-	-	-	-	-	1	-	-	-	-	-	0.1

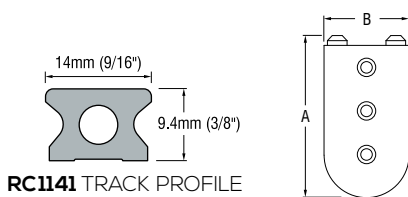

© Dragonfly

RC1141 TRACK PROFILE

Refer to page 144 and the SUPPORT tab at www.ronstan.com for system schematics and installation information.

TRACK FASTENINGS – M4 (5/32") cylinder head fasteners at 37.5mm (1 1/2") centres.

PRODUCT No.	DESCRIPTION	A	B	C	WEIGHT	A	B	C	WEIGHT
		mm	mm	mm	g	in	in	in	oz
Series 14									
RC1141-2.0*1	Track, 1975mm (77 13/16") long, black	14	9.4	-	421	9/16	3/8	-	14.9
RC1141-3.0*1&2	Track, 3025mm (119 3/16") long, black	14	9.4	-	625	9/16	3/8	-	22.0
RC1141J	Track joiner, acetal	-	-	-	1	-	-	-	0.1
RC11480	End cap, plastic, L28mm x W20mm (1 1/8" x 25/32")	-	-	-	6	-	-	-	0.2
RC11481	End stop, plastic	68	33.0	-	11	2 11/16	1 5/16	-	0.4
RC1149-0.2*1	Gate track, 250mm (9 27/32") long, black	14	9.4	-	52	9/16	3/8	-	1.8

*1 Silver track available - Order as RCxxxxxxS

*2 Longer track available on request.

SERIES 19 BB

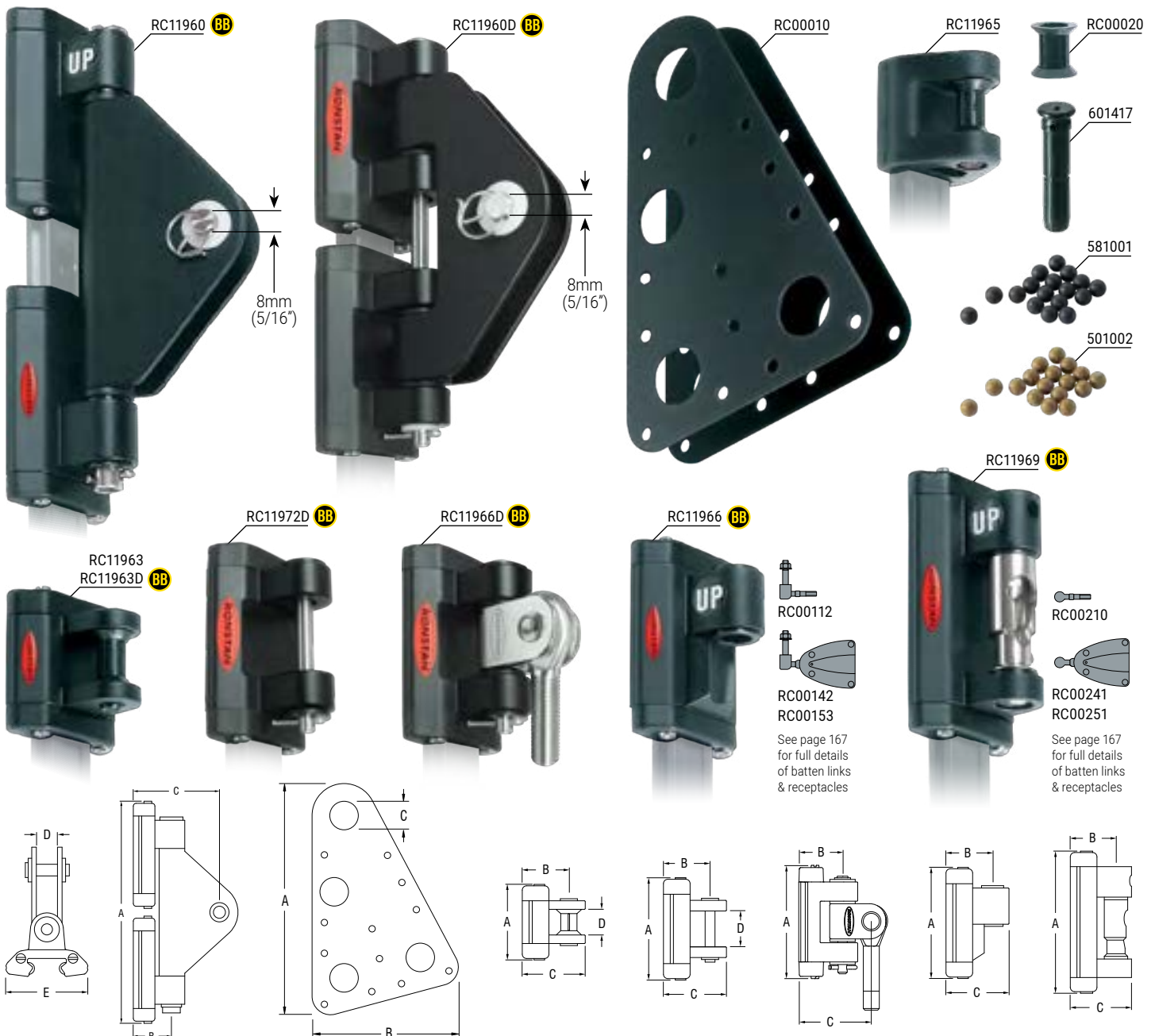

- Multihulls to 11m (36ft) or sail area 37m² (398ft²).
- Monohulls to 14m (46ft) or sail area 44m² (474ft²).
- RC119xxD - suitable for multihulls to 10m (33ft) or sail area 36m² (388ft²).
- RC119xxD - suitable for monohulls to 13m (43ft) or sail area 43m² (463ft²).

PRODUCT No.	DESCRIPTION	A	B	C	D	E	WEIGHT	A	B	C	D	E	WEIGHT
		mm	mm	mm	mm	mm	g	in	in	in	in	in	oz
Series 19 BB													
RC00010	Headboard plates (pair)	188	119	23	-	-	173	7 13/32	4 11/16	29/32	-	-	6.1
RC11960	Headboard car	171	26	65	11.5	47	310	6 3/4	1 1/32	2 9/16	7/16	1 27/32	11.0
RC11960D	Headboard car	146	27	63	12.2	47	270	5 3/4	1 1/16	2 15/32	15/32	1 27/32	9.5
RC11963	Intermediate car	51	27	37	18.0	47	61	2	1 1/16	1 15/32	23/32	1 27/32	2.2
RC11963D	Intermediate car	51	27	37	18.0	47	61	2	1 1/16	1 15/32	23/32	1 27/32	2.2
RC11965	Track slide, acetal	37	26	36	17.5	38	25	1 15/32	1 1/32	1 13/32	11/16	1 1/2	0.9
RC11966	Batten car	66	26	36	-	47	75	2 19/32	1 1/32	1 13/32	-	1 27/32	2.6
RC11966D	Batten car, includes receptacle link M10	71	27	45	M10	47	204	2 13/16	1 1/16	1 25/32	M10	1 27/32	7.2
RC11969	Quick release batten car	88	26	36	-	47	145	3 15/32	1 1/32	1 13/32	-	1 27/32	5.1
RC11972D	Reef car, pin diam. Ø5.9mm (7/32")	71	27	37	26.0	47	100	2 13/16	1 1/16	1 15/32	1 1/32	1 27/32	3.5
Spare Parts													
581001	Ball bearing, acetal, 5.00mm (0.197") diameter (suits cars with "D" part number suffix)	-	-	-	-	-	1	-	-	-	-	-	0.1
501002	Ball bearing, Torlon®, 5.00mm (0.197") diameter	-	-	-	-	-	1	-	-	-	-	-	0.1
601417	Replacement pin for RC11963, RC11963D	-	-	-	-	-	4	-	-	-	-	-	0.1
RC00020	Replacement bush for RC11963, RC11963D	-	-	-	-	-	1	-	-	-	-	-	0.1

Torlon® is a registered trademark of Solvay Advanced Polymers

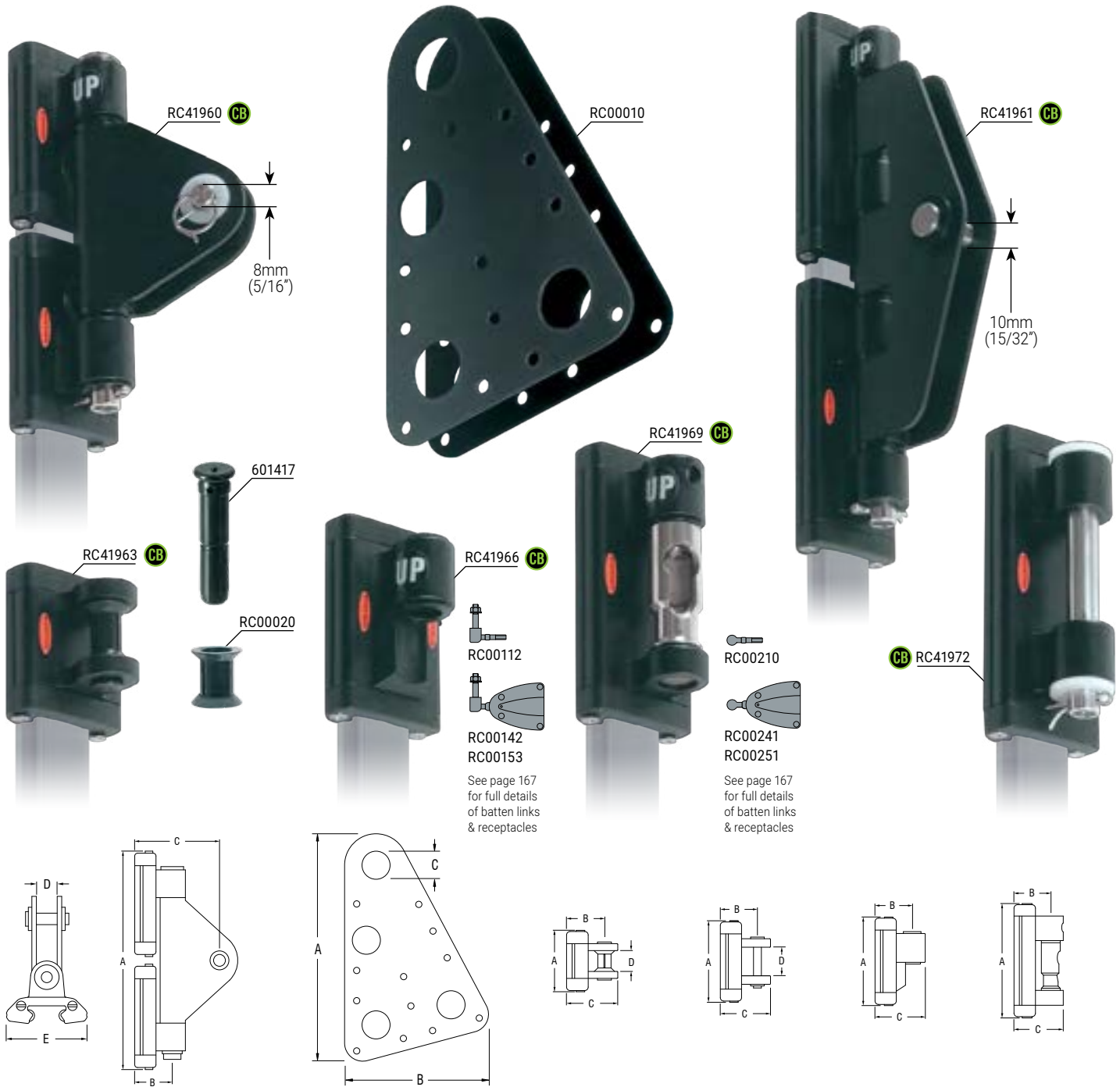

⬆ Long cars: Monohulls to 15m (50ft)
or sail area 53m² (570ft²).

⬆ Long cars: Multihulls to 12m (40ft)
or sail area 46m² (495ft²).

⬆ Short cars: Monohulls to 14m (46ft)
or sail area 48m² (517ft²).

⬆ Short cars: Multihulls to 11m (36ft)
or sail area 41m² (441ft²).

PRODUCT No.	DESCRIPTION	A	B	C	D	E	WEIGHT	A	B	C	D	E	WEIGHT
		mm	mm	mm	mm	mm	g	in	in	in	in	in	oz
Series 19 CB													
RC00010	Headboard plates (pair)	188	119	23	-	-	173	7 13/32	4 11/16	29/32	-	-	6.1
RC41960	Headboard car (short)	126	29	66	12.2	39	243	4 15/16	1 1/8	2 5/8	15/32	1 9/16	8.6
RC41961	Headboard car (long)	209	29	64	12.2	39	420	8 3/16	1 1/8	2 1/2	15/32	1 9/16	14.8
RC41963	Intermediate car	44	29	38	18.0	39	57	1 5/8	1 1/8	1 7/16	1 1/16	1 9/16	2.0
RC41966	Batten car	61	29	38	-	39	76	2 3/8	1 1/8	1 7/16	-	1 9/16	2.7
RC41969	Quick release batten car	84	29	38	-	39	144	3 1/4	1 1/8	1 7/16	-	1 9/16	5.1
RC41972	Reef car, pin diam. Ø9.9mm (13/32")	98	29	38	37.0	39	151	3 3/4	1 1/8	1 7/16	1 7/16	1 9/16	5.3
Spare Parts													
601417	Replacement pin for RC41963	-	-	-	-	-	4	-	-	-	-	-	0.1
RC00020	Replacement bush for RC41963	-	-	-	-	-	1	-	-	-	-	-	0.1

SERIES 19 TRACK

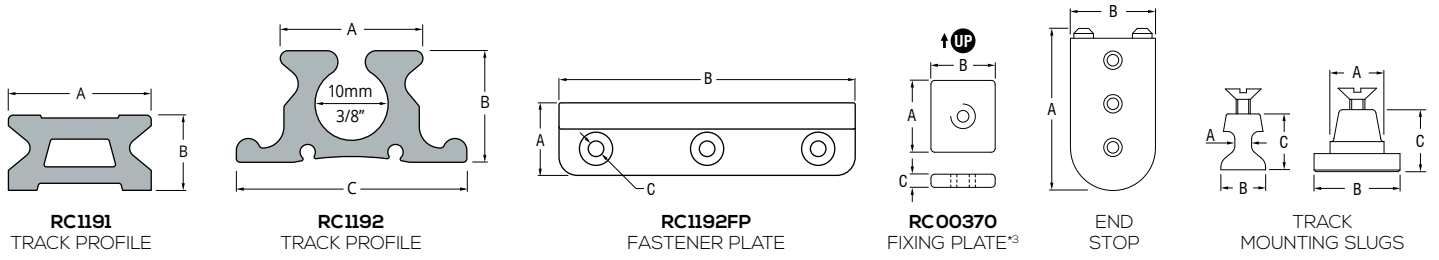

Refer to page 144 and the SUPPORT tab at www.ronstan.com for full track mounting slug details, system schematics and installation information.

TRACK FASTENINGS – M5 (3/16") countersunk head fasteners at 100mm (3 15/16") centres.

PRODUCT No.	DESCRIPTION	A	B	C	WEIGHT	A	B	C	WEIGHT
		mm	mm	mm	g	in	in	in	oz
Series 19									
RC00310	Track mounting slug, including M5 screw	3.7	9.4	13.5	4	5/32	3/8	17/32	0.1
RC00312	Track mounting slug, including M5 screw	2.8	7.6	12.6	3	1/8	5/16	1/2	0.1
RC00315	Track mounting slug, including M5 screw	4.6	12.7	16.0	5	3/16	1/2	5/8	0.2
RC00316	Track mounting slug, including M5 screw	3.6	11.0	15.0	5	5/32	7/16	19/32	0.2
RC00321	Track mounting slug, including M5 screw	11.8	19.9	13.0	8	15/32	25/32	1/2	0.3
RC00322	Track mounting slug, including M5 screw	13.5	21.0	13.0	9	15/32	27/32	1/2	0.3
RC00323	Track mounting slug, including M5 screw	8.1	15.0	13.5	6	5/16	19/32	17/32	0.2
RC00370	Track fixing plate, suits Series 19, M5 thread	25.0	20.0	5.0	6	1	25/32	3/16	0.2
RC1191-2.0*1	Track, 2025mm (79 3/4") long, black. Requires 21 track mounting slugs	19.4	10.4	-	614	25/32	13/32	-	21.7
RC1191-3.0*1&2	Track, 3025mm (119 3/16") long, black. Requires 31 track mounting slugs	19.4	10.4	-	932	25/32	13/32	-	32.9
RC1192-2.0*1	Luff groove track, 2025mm (79 3/4") long, black	19.5	15.3	31.5	1090	25/32	19/32	1 1/4	38.4
RC1192-3.0*1&2	Luff groove track, 3025mm (119 3/16") long, black	19.5	15.3	31.5	1630	25/32	19/32	1 1/4	57.5
RC1192FP	Luff groove track clamping plates, black (pair)	19.6	80.0	4.0	11	25/32	3 5/32	5/32	0.4
RC1191J	Track joiner, acetal	-	-	-	3	-	-	-	0.1
RC1192J	Luff groove track joiners (pair)	-	-	-	1	-	-	-	0.1J
RC1199-0.3*1	Gate track, 325mm (12 13/16") long, black. Requires 4 track mounting slugs	19.0	10.4	-	97	3/4	13/32	-	3.4
RC1199-0.3L*1	Luff groove gate track, 325mm (12 13/16") long, black	19.5	15.3	31.5	175	25/32	19/32	1 1/4	6.2
RC11980	End cap, plastic, L30mm x W26mm (1 3/16" x 1 1/32")	-	-	-	6	-	-	-	0.2
RC11981	End stop, plastic	70.0	38.0	-	15	2 3/4	1 1/2	-	0.5

*1 Silver track available - Order as RCxxxxxxxS
 *2 Longer track available on request.
 *3 For correct alignment of fasteners, position track fixing plates with long sides parallel with mast groove

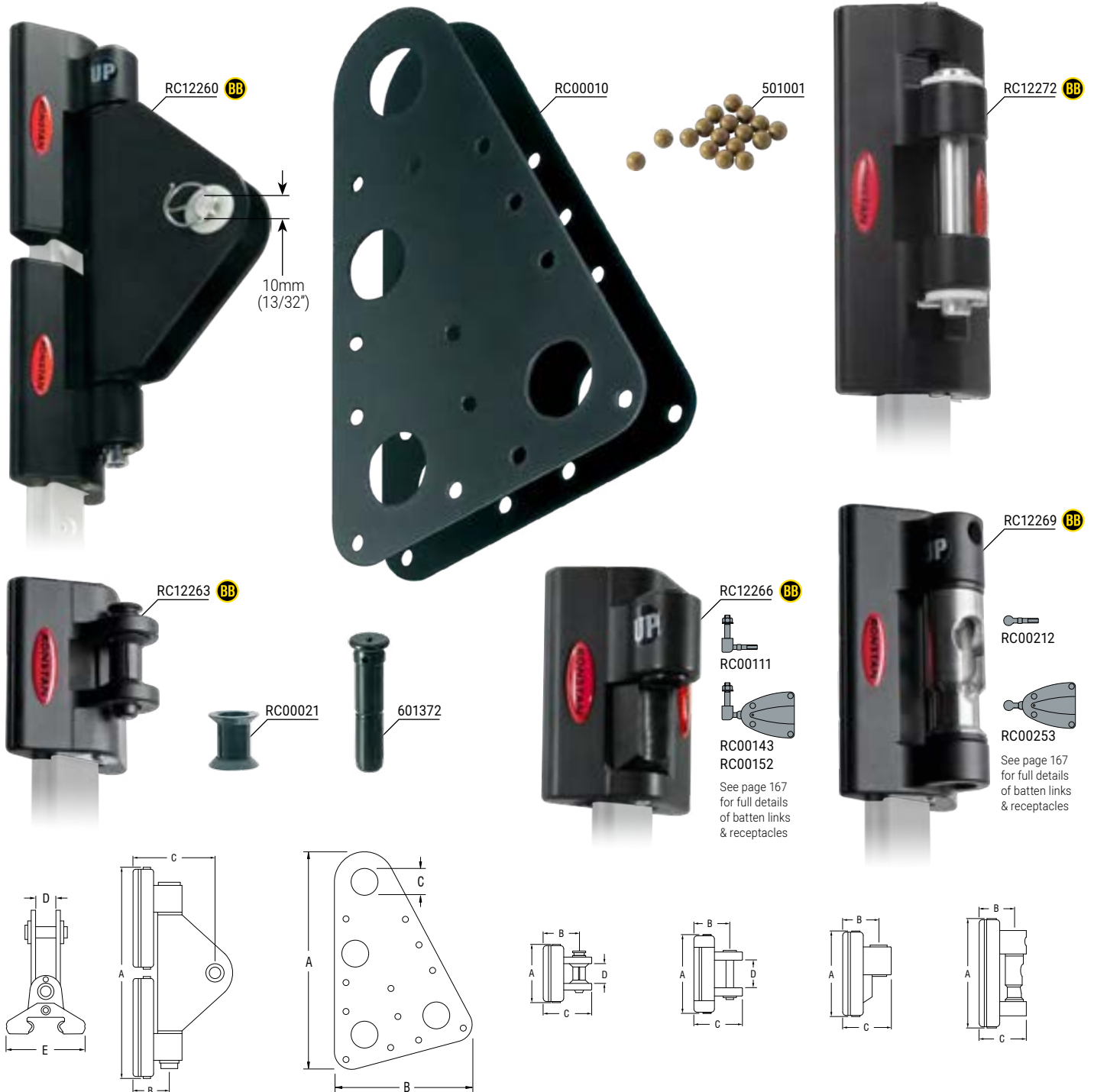

Monohulls to 18m (60ft)
 or sail area 58m² (624ft²).

Multihulls to 12m (40ft)
 or sail area 46m² (495ft²).

PRODUCT No.	DESCRIPTION	A	B	C	D	E	WEIGHT	A	B	C	D	E	WEIGHT
		mm	mm	mm	mm	mm	g	in	in	in	in	in	oz
Series 22 BB													
RC00010	Headboard plates (pair)	188	119	23	-	-	173	7 13/32	4 11/16	29/32	-	-	6.1
RC12260	Headboard car	206	33	78	17	57.5	584	8 1/8	1 5/16	3 1/16	2 1/32	2 1/4	20.6
RC12263	Intermediate car	64	33	45	18	57.5	110	2 17/32	1 5/16	1 25/32	23/32	2 1/4	3.9
RC12266	Batten car	77	33	45	-	57.5	155	3 1/32	1 5/16	1 25/32	-	2 1/4	5.5
RC12269	Quick release batten car	120	33	45	-	57.5	360	4 23/32	1 5/16	1 25/32	-	2 1/4	12.7
RC12272	Reef car, pin diam. Ø9.9mm (13/32")	130	33	45	32	57.5	350	5 1/8	1 5/16	1 25/32	1 1/4	2 1/4	12.3
Spare Parts													
501001	Ball bearing, Torton®, 6.35mm (1/4") diameter	-	-	-	-	-	1	-	-	-	-	-	0.1
601372	Replacement pin for RC12263	-	-	-	-	-	5	-	-	-	-	-	0.2
RC00021	Replacement bush for RC12263	-	-	-	-	-	1	-	-	-	-	-	0.1

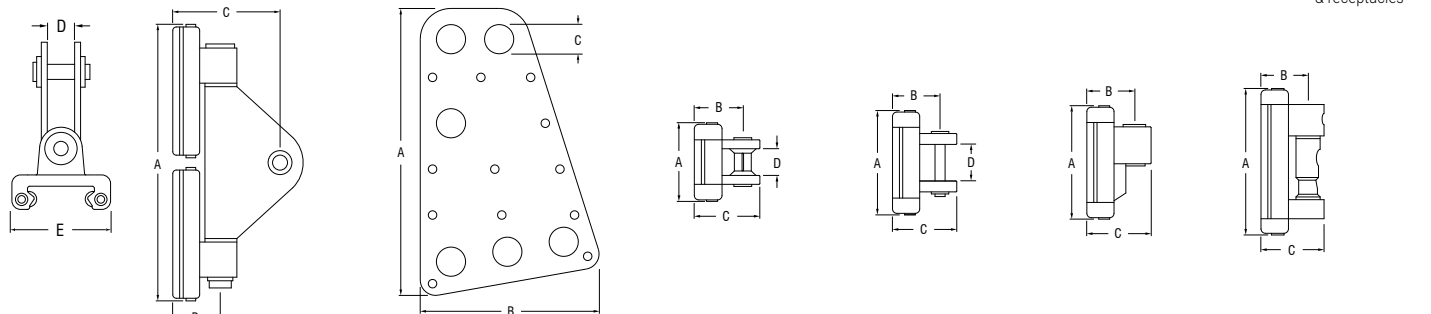
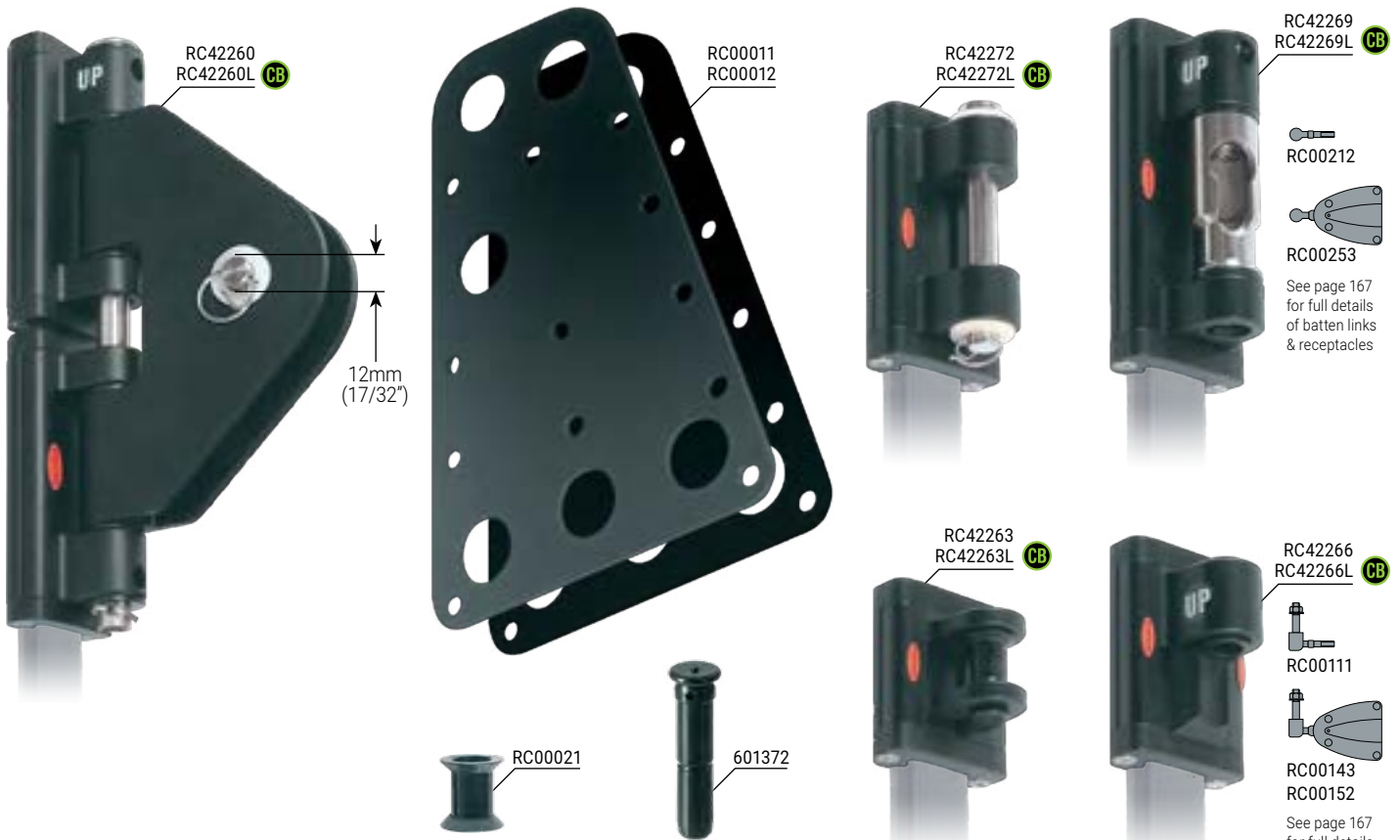

⬆ Monohulls to 18m (60ft) or sail area 70m² (753ft²).
 ⬆ Multihulls to 13m (43ft) or sail area 57m² (614ft²).

PRODUCT No.	DESCRIPTION	A	B	C	D	E	WEIGHT	A	B	C	D	E	WEIGHT
		mm	mm	mm	mm	mm	g	in	in	in	in	in	oz
Series 22 ^{CB} Cars for Standard Track													
RC42260	Headboard car	235	34	95	17	47	814	9 1/4	1 11/32	3 3/4	21/32	1 7/8	28.7
RC42263	Intermediate car	54	34	46	18	47	102	2 1/8	1 11/32	1 25/32	23/32	1 7/8	3.6
RC42266	Batten car	72	34	46	-	47	142	2 27/32	1 11/32	1 25/32	-	1 7/8	5.0
RC42269	Quick release batten car	116	34	46	-	47	336	4 9/16	1 11/32	1 25/32	-	1 7/8	11.8
RC42272	Reef car, pin diam. Ø9.9mm (13/32")	86	34	46	32	47	224	3 13/32	1 11/32	1 25/32	1 1/4	1 7/8	7.9
Series 22 ^{CB} Cars for Luff Groove Track													
RC42260L	Headboard car	235	34	95	17	47	814	9 1/4	1 11/32	3 3/4	21/32	1 7/8	28.7
RC42263L	Intermediate car	54	34	46	18	47	102	2 1/8	1 11/32	1 25/32	23/32	1 7/8	3.6
RC42266L	Batten car	72	34	46	-	47	142	2 27/32	1 11/32	1 25/32	-	1 7/8	5.0
RC42269L	Quick release batten car	116	34	46	-	47	334	4 9/16	1 11/32	1 25/32	-	1 7/8	11.8
RC42272L	Reef car, pin diam. Ø9.9mm (13/32")	86	34	46	32	47	224	3 13/32	1 11/32	1 25/32	1 1/4	1 7/8	7.9

Spare Parts & Accessories													
601372	Replacement pin for RC42263	-	-	-	-	-	5	-	-	-	-	-	0.2
RC00011	Headboard plates (pair)	280	175	28	-	-	540	11 1/32	6 29/32	1 3/32	-	-	19.0
RC00012	Headboard plates (pair)	280	175	23	-	-	540	11 1/32	6 29/32	29/32	-	-	19.0
RC00021	Replacement bush for RC42263	-	-	-	-	-	1	-	-	-	-	-	0.1

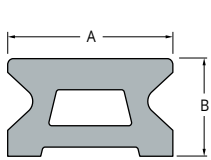
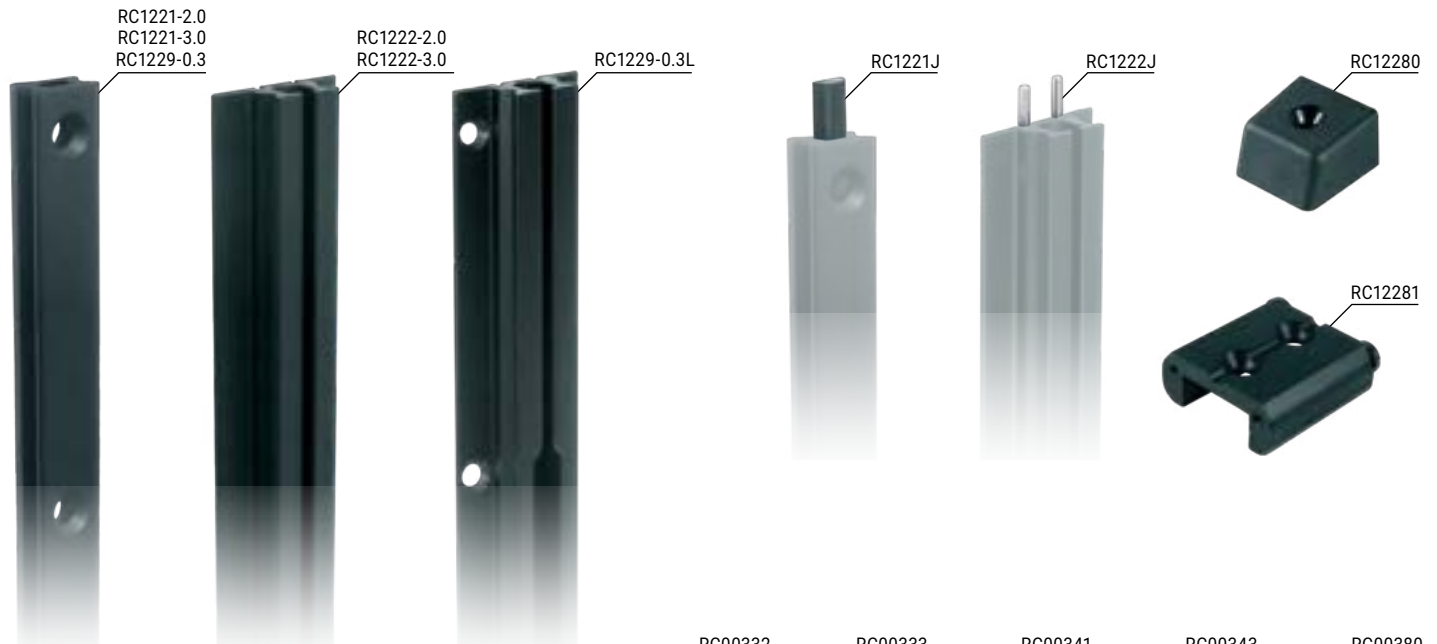
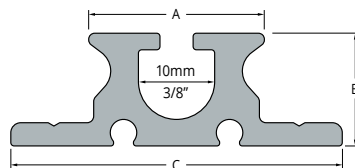
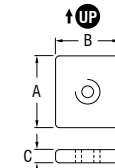
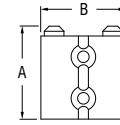
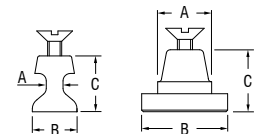
RC1221
TRACK PROFILE

RC1222
TRACK PROFILE

RC00380
FIXING PLATE*³

RC12281
END STOP

 TRACK
MOUNTING SLUGS

Refer to page 144 and the SUPPORT tab at www.ronstan.com for full track mounting slug details, system schematics and installation information.

TRACK FASTENINGS – M6 (1/4") countersunk head fasteners at 100mm (3 15/16") centres.

PRODUCT No.	DESCRIPTION	A	B	C	WEIGHT	A	B	C	WEIGHT
		mm	mm	mm	g	in	in	in	oz
Series 22									
RC00332	Track mounting slug, including M6 screw	3.5	8.3	16.1	5	1/8	5/16	5/8	0.2
RC00333	Track mounting slug, including M6 screw	4.6	13.0	18.0	6	3/16	1/2	23/32	0.2
RC00341	Track mounting slug, including M6 screw	13.6	21.0	15.5	11	17/32	27/32	5/8	0.4
RC00343	Track mounting slug, including M6 screw	11.8	19.8	15.5	10	15/32	25/32	5/8	0.4
RC00380	Track fixing plate, suits Series 22 & 26, M6 thread	25.0	20.0	5.0	6	1	3/4	3/16	0.2
RC1221-2.0* ¹	Track, 2025 mm (79 25/32") long, black. Requires 21 track mounting slugs	22.0	13.0	-	956	7/8	1/2	-	33.7
RC1221-3.0* ^{1&2}	Track, 3025mm (119 3/16") long, black. Requires 31 track mounting slugs	22.0	13.0	-	1453	7/8	1/2	-	51.2
RC1221J	Track joiner, acetal	-	-	-	4	-	-	-	0.1
RC1222-2.0* ¹	Luff groove track, 2025mm (79 25/32") long, black	22.0	15.0	44.0	1185	7/8	19/32	1 23/32	41.8
RC1222-3.0* ^{1&2}	Luff groove track, 3025mm (119 3/16") long, black	22.0	15.0	44.0	1770	7/8	19/32	1 23/32	62.4
RC1222J	Luff groove track joiner (pair)	-	-	-	2	-	-	-	0.1
RC1229-0.3* ¹	Gate track, 325mm (12 13/16") long, black. Requires 4 track mounting slugs	22.0	13.0	-	156	7/8	1/2	-	5.5
RC1229-0.3L* ¹	Luff groove gate track, 325mm (12 13/16") long, black	22.0	15.0	44.0	190	7/8	19/32	1 23/32	6.7
RC12280	End cap, plastic, L30mm x W26mm (1 3/16" x 1 1/32")	-	-	-	7	-	-	-	0.2
RC12281* ¹	End stop, alloy	50.0	45.0	-	50	1 31/32	1 25/32	-	1.8

*1 Silver track available - Order as RCxxxxxxS

*2 Longer track available on request.

*3 For correct alignment of fasteners, position track fixing plates with long sides parallel with mast groove

SERIES 26 BB

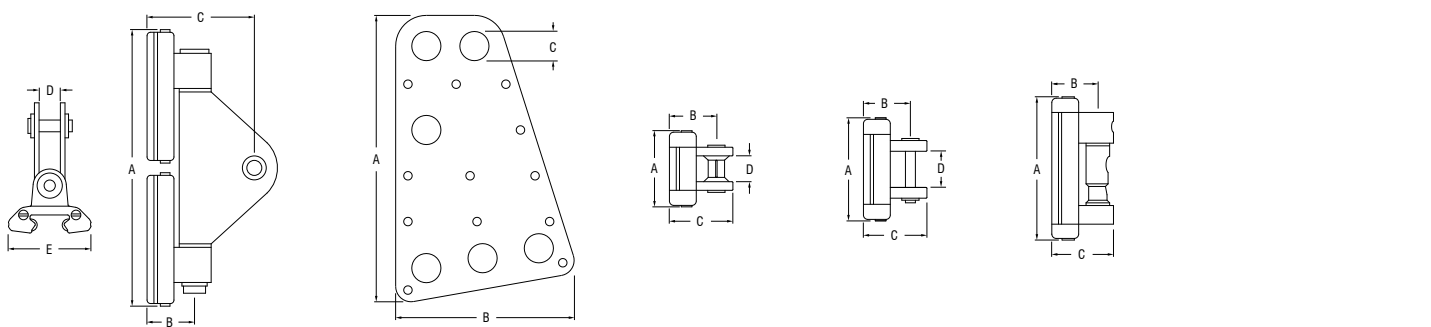
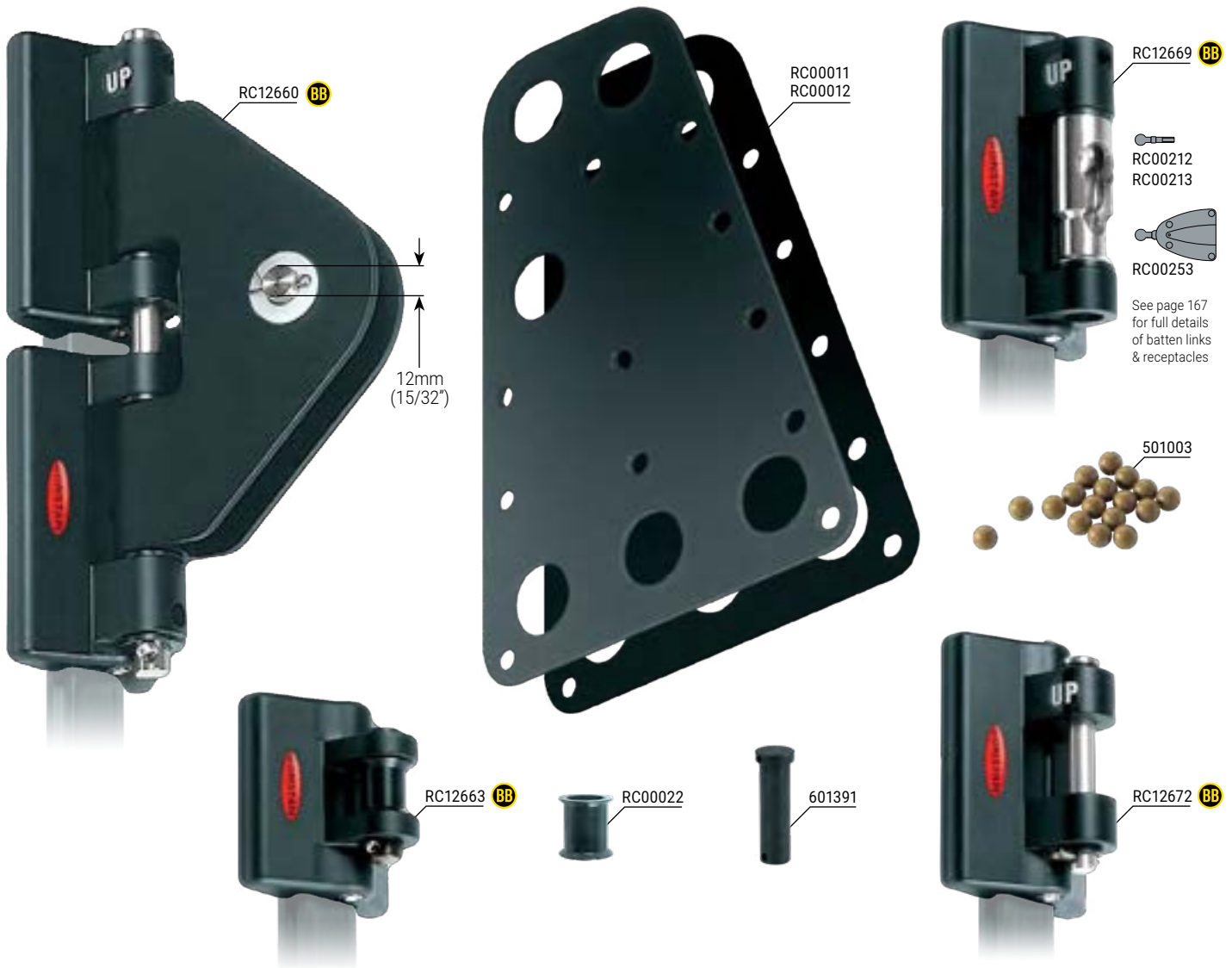

Monohulls to 20m (65ft) or sail area 85m² (915ft²).
 Multihulls to 14m (46ft) or sail area 65m² (700ft²).

PRODUCT No.	DESCRIPTION	A	B	C	D	E	WEIGHT	A	B	C	D	E	WEIGHT
		mm	mm	mm	mm	mm	g	in	in	in	in	in	oz
Series 26 BB													
RC00011	Headboard plates (pair)	280	175	28	-	-	540	11 1/32	6 29/32	1 3/32	-	-	19.0
RC00012	Headboard plates (pair)	280	175	23	-	-	540	11 1/32	6 29/32	29/32	-	-	19.0
RC12660	Headboard car	225	36	99	16	69	977	8 7/8	1 13/32	3 29/32	5/8	2 23/32	34.5
RC12663	Intermediate car	70	36	48	18	69	167	2 3/4	1 13/32	1 29/32	23/32	2 23/32	5.9
RC12669	Quick release batten car	110	36	48	-	69	385	4 5/16	1 13/32	1 29/32	-	2 23/32	13.6
RC12672	Reef car, pin diam. Ø9.9mm (13/32")	90	36	48	28	69	285	3 17/32	1 13/32	1 29/32	1 3/32	2 23/32	10.1

Spare Parts

501003	Ball bearing, Torton®, 7.95mm (5/16") diameter	-	-	-	-	-	1	-	-	-	-	-	0.1
601391	Replacement pin for RC12663	-	-	-	-	-	7	-	-	-	-	-	0.2
RC00022	Replacement bush for RC12663	-	-	-	-	-	1	-	-	-	-	-	0.1

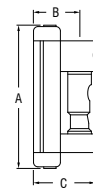
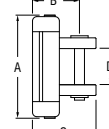
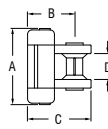
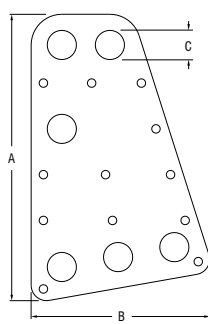
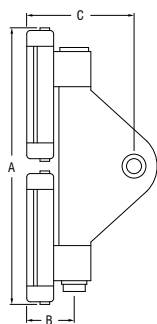
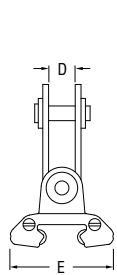
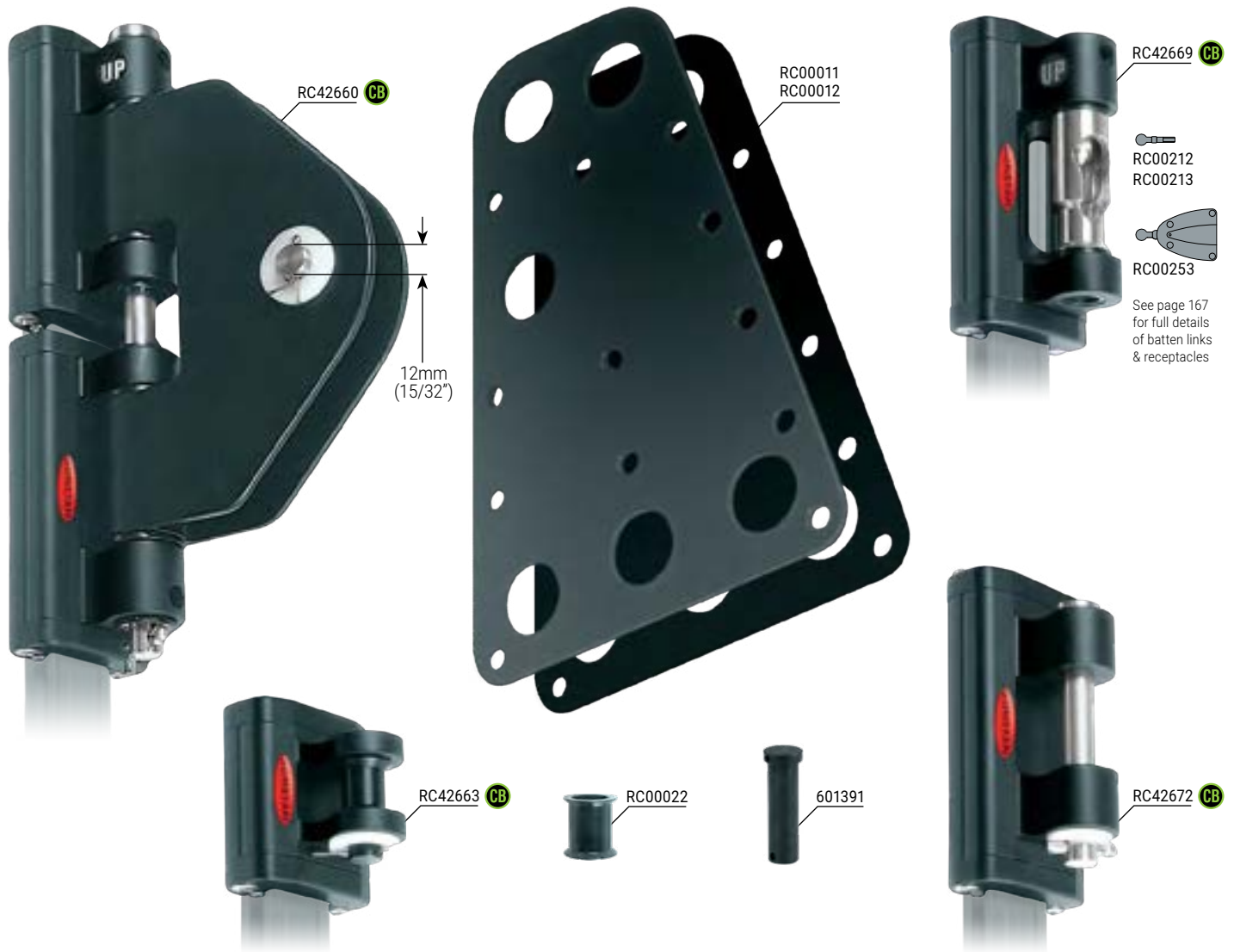

⬆ Monohulls to 22m (72ft)
or sail area 105m² (1130ft²).

⬆ Multihulls to 16m (53ft)
or sail area 83m² (893ft²).

⬆ Suits series 26 track (standard
and luff groove type tracks).

PRODUCT No.	DESCRIPTION	A	B	C	D	E	WEIGHT	A	B	C	D	E	WEIGHT
		mm	mm	mm	mm	mm	g	in	in	in	in	in	oz
Series 26 CB													
RC00011	Headboard plates (pair)	280	175	28	-	-	540	11 1/32	6 29/32	1 3/32	-	-	19.0
RC00012	Headboard plates (pair)	280	175	23	-	-	540	11 1/32	6 29/32	29/32	-	-	19.0
RC42660	Headboard car	236	37	96	17	52	971	9 5/16	1 7/16	3 25/32	1 1/16	2 1/16	34.3
RC42663	Intermediate car	64	37	49	19	52	132	2 1/2	1 7/16	1 15/16	3/4	2 1/16	4.7
RC42669	Quick release batten car	115	37	49	-	52	352	4 11/16	1 7/16	1 15/16	-	2 1/16	12.4
RC42672	Reef car, pin diam. Ø11.8mm (15/32")	90	37	49	28	52	270	3 9/16	1 7/16	1 15/16	1 1/8	2 1/16	9.5
Spare Parts													
601391	Replacement pin for RC42663	-	-	-	-	-	7	-	-	-	-	-	0.2
RC00022	Replacement bush for RC42663	-	-	-	-	-	1	-	-	-	-	-	0.1

SERIES 26 TRACK

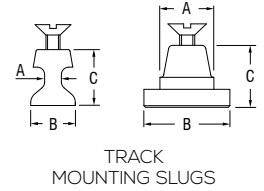
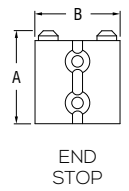
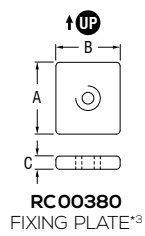
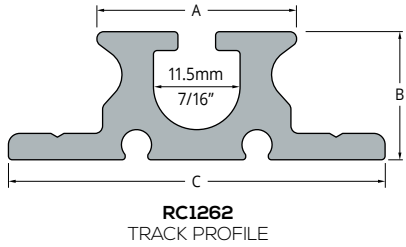
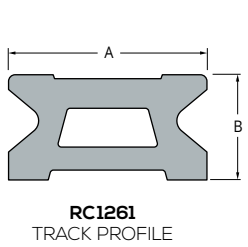
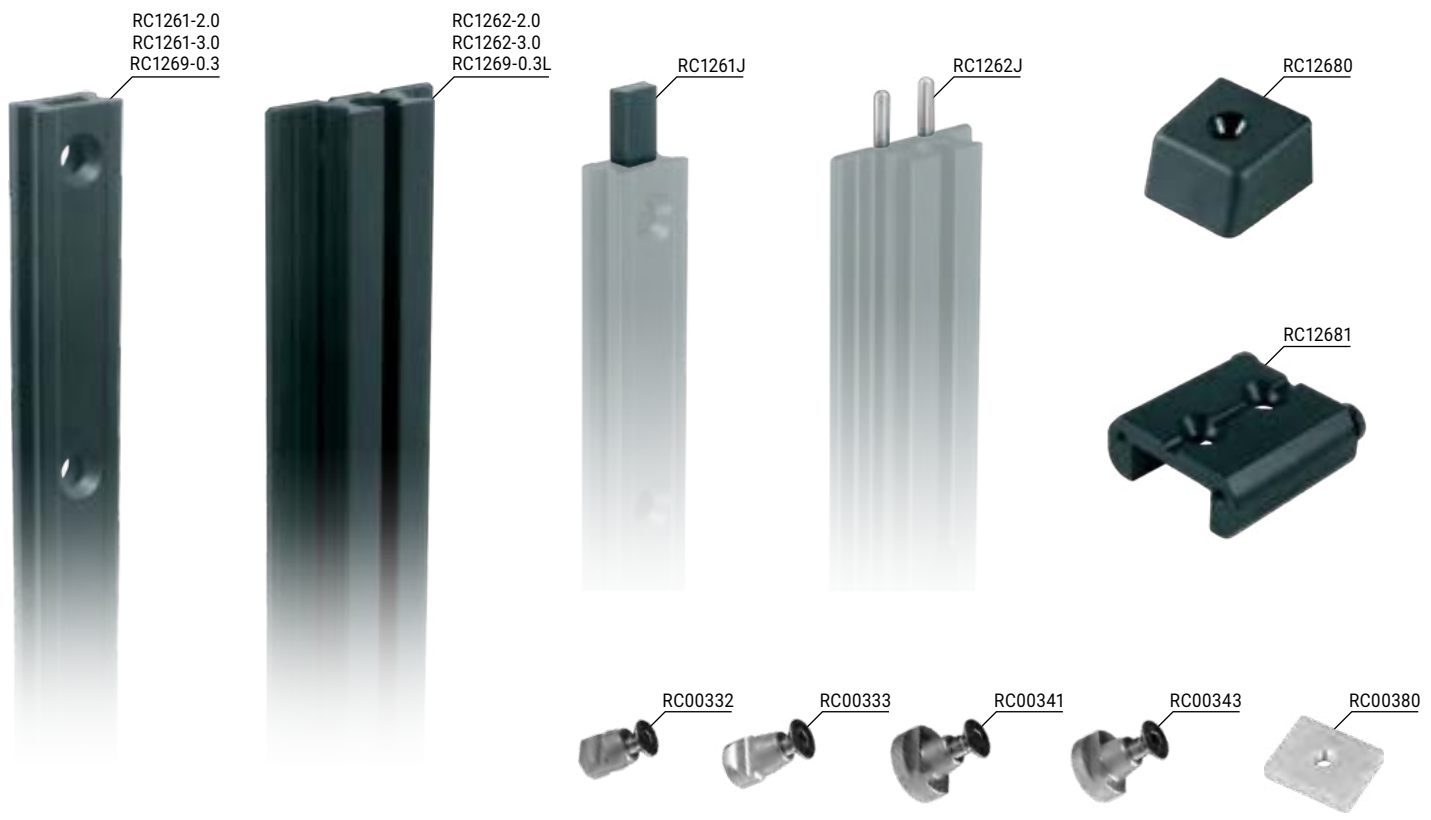

Refer to page 144 and the SUPPORT tab at www.ronstan.com for full track mounting slug details, system schematics and installation information.

TRACK FASTENINGS – M6 (1/4") countersunk head fasteners at 75mm (2 15/16") centres.

PRODUCT No.	DESCRIPTION	A	B	C	WEIGHT	A	B	C	WEIGHT
		mm	mm	mm	g	in	in	in	oz
Series 26									
RC00332	Track mounting slug, including M6 screw	3.5	8.3	16.1	5	1/8	5/16	5/8	0.2
RC00333	Track mounting slug, including M6 screw	4.6	13.0	18.0	6	3/16	1/2	23/32	0.2
RC00341	Track mounting slug, including M6 screw	13.6	21.0	15.5	11	17/32	27/32	5/8	0.4
RC00343	Track mounting slug, including M6 screw	11.8	19.8	15.5	10	15/32	25/32	5/8	0.4
RC00380	Track fixing plate, suits Series 22 & 26, M6 thread	25.0	20.0	5.0	6	1	3/4	3/16	0.2
RC1261-2.0*1	Track, 2025 mm (79 25/32") long, black. Requires 27 track mounting slugs	26.4	13.5	-	1190	1 1/32	17/32	-	42.0
RC1261-3.0*1&2	Track, 3025 mm (119 3/16") long, black. Requires 41 track mounting slugs	26.4	13.5	-	1780	1 1/32	17/32	-	62.8
RC1261J	Track joiner, acetal	-	-	-	5	-	-	-	0.2
RC1262-2.0*1	Luff groove track, 2025 mm (79 25/32") long, black	26.4	17.0	50.0	1825	1 1/32	21/32	1 31/32	64.4
RC1262-3.0*1&2	Luff groove track, 3025 mm (119 3/16") long, black	26.4	17.0	50.0	2725	1 1/32	21/32	1 31/32	96.1
RC1262J	Luff groove track joiner (pair)	-	-	-	4	-	-	-	0.1
RC12680	End cap, plastic, L34mm x W32mm (1 5/16" x 1 1/4")	-	-	-	7	-	-	-	0.2
RC12681	End stop, alloy	55.0	45.0	-	73	2 5/32	1 25/32	-	2.6
RC1269-0.3*1	Gate track, 325mm (12 13/16") long, black. Requires 4 track mounting slugs	26.4	13.5	-	196	1 1/32	17/32	-	6.9
RC1269-0.3L*1	Luff groove gate track, 325mm (12 13/16") long, black	26.4	17.0	50.0	290	1 1/32	21/32	1 31/32	10.2

*1 Silver track available - Order as RCxxxxxxxS
 *2 Longer track available on request.
 *3 For correct alignment of fasteners, position track fixing plates with long sides parallel with mast groove

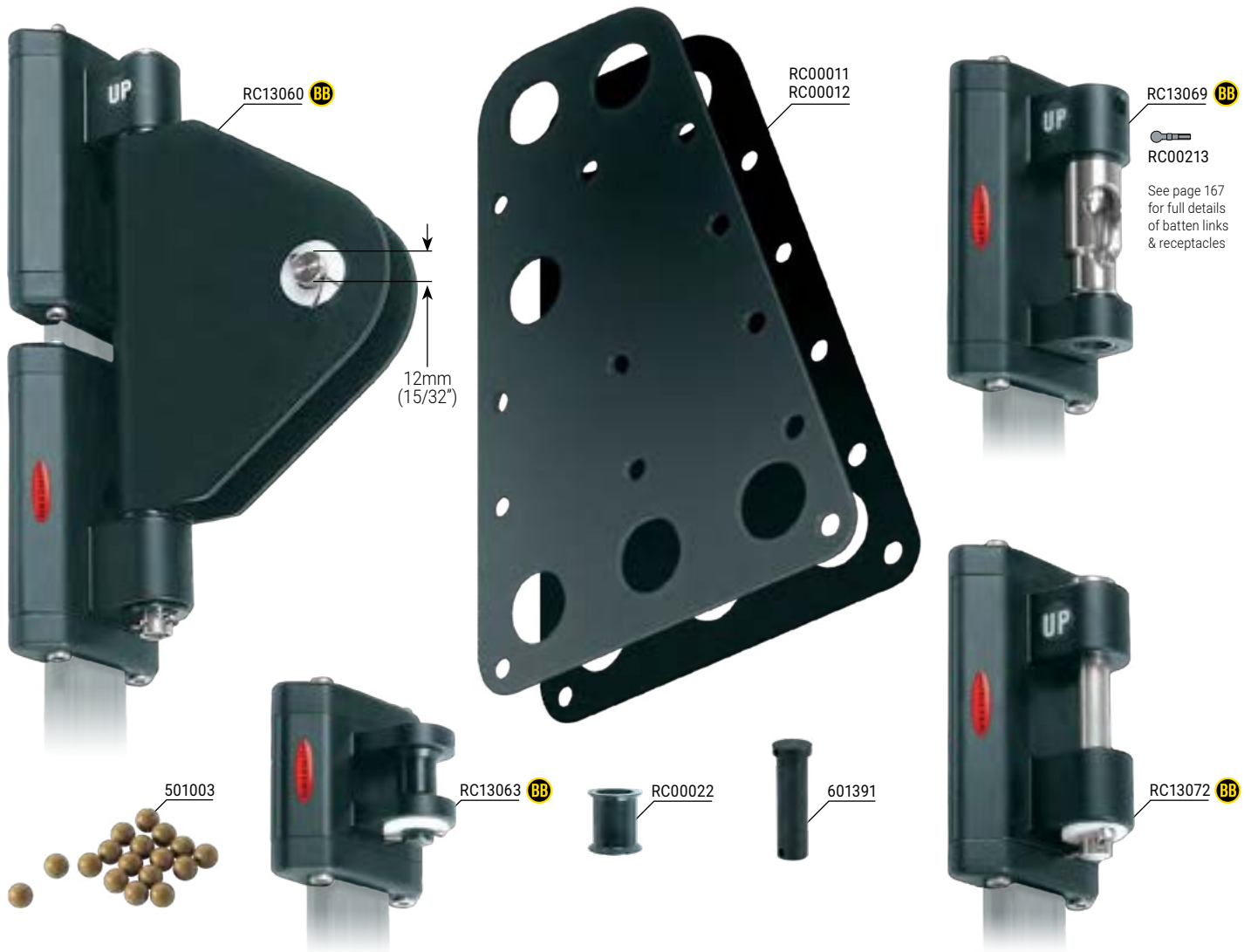

See page 167
for full details
of batten links
& receptacles

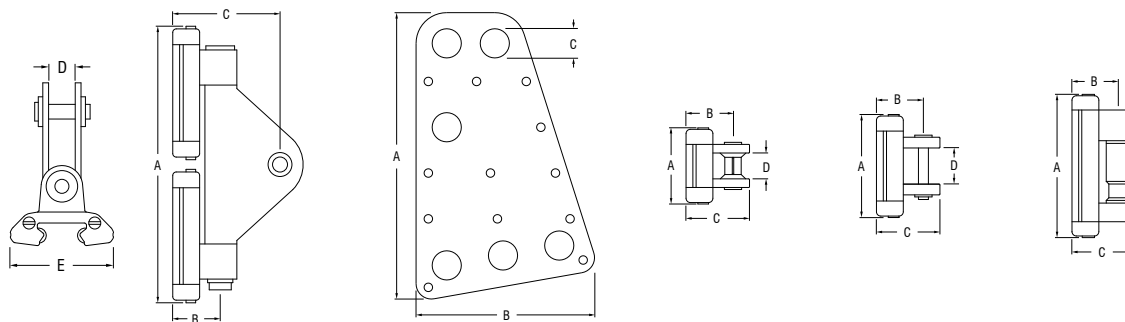

Monohulls to 23m (75ft)
or sail area 120m² (1292ft²).

Multihulls to 17m (56ft)
or sail area 93m² (1001ft²).

PRODUCT No.	DESCRIPTION	A	B	C	D	E	WEIGHT	A	B	C	D	E	WEIGHT
		mm	mm	mm	mm	mm	g	in	in	in	in	in	oz
Series 30 BB													
RC00011	Headboard plates (pair)	280	175	28	-	-	540	11 1/32	6 29/32	1 3/32	-	-	19.0
RC00012	Headboard plates (pair)	280	175	23	-	-	540	11 1/32	6 29/32	29/32	-	-	19.0
RC13060	Headboard car	255	43	120	20	76.4	1245	10 1/16	1 11/16	4 23/32	25/32	3	43.9
RC13063	Intermediate car	78	43	56	19	76.4	230	3 1/16	1 11/16	2 7/32	3/4	3	8.1
RC13069	Quick release batten car	129	43	56	-	76.4	555	5 3/32	1 11/16	2 7/32	-	3	19.6
RC13072	Reef car, pin diam. Ø11.8mm (15/32")	130	43	56	37	76.4	534	5 1/8	1 11/16	2 7/32	15/32	3	18.8
Spare Parts													
501003	Ball bearing, Torlon®, 7.95mm (5/16") diameter	-	-	-	-	-	1	-	-	-	-	-	0.1
601391	Replacement pin for RC13063	-	-	-	-	-	7	-	-	-	-	-	0.2
RC00022	Replacement bush for RC13063	-	-	-	-	-	1	-	-	-	-	-	0.1

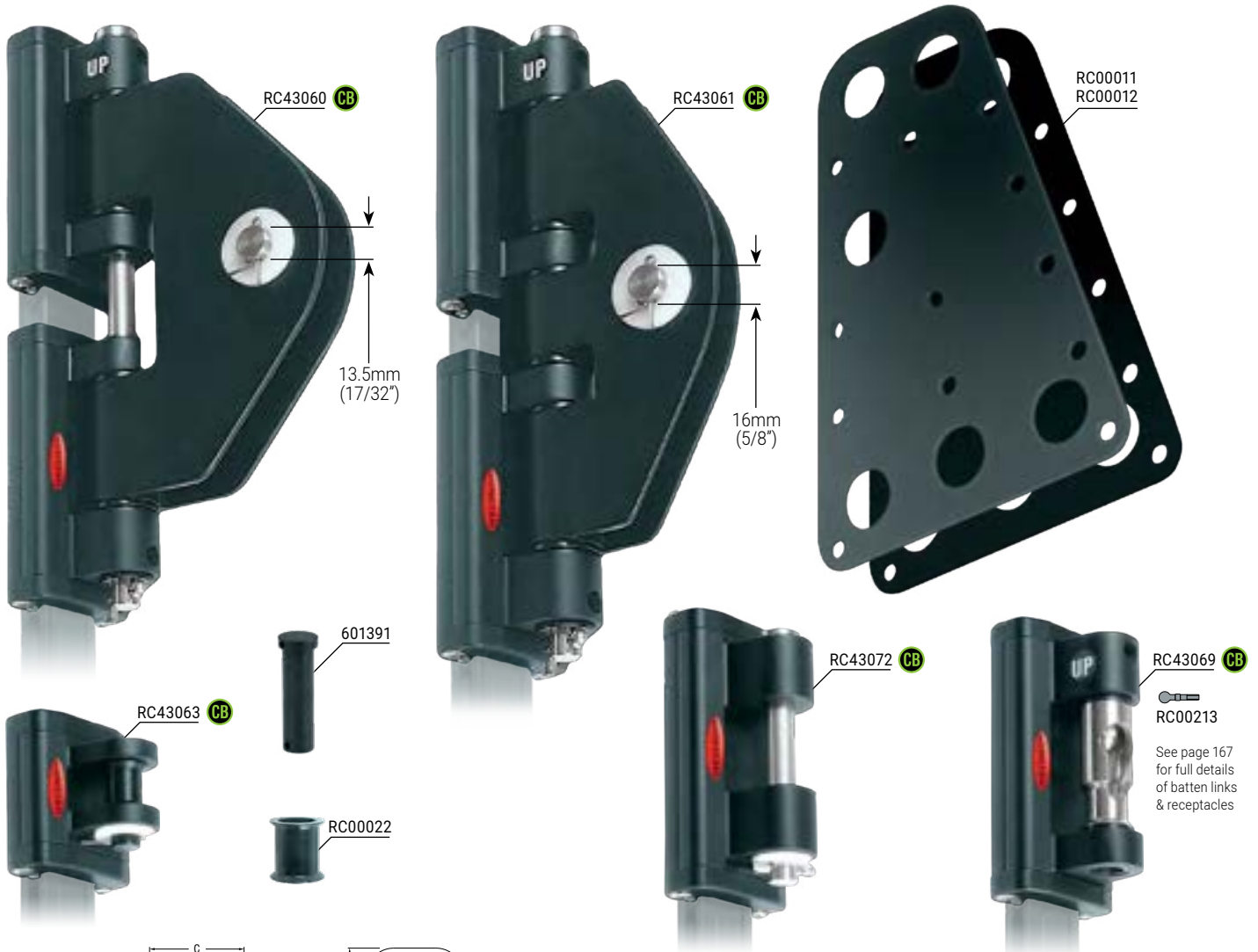

See page 167 for full details of batten links & receptacles

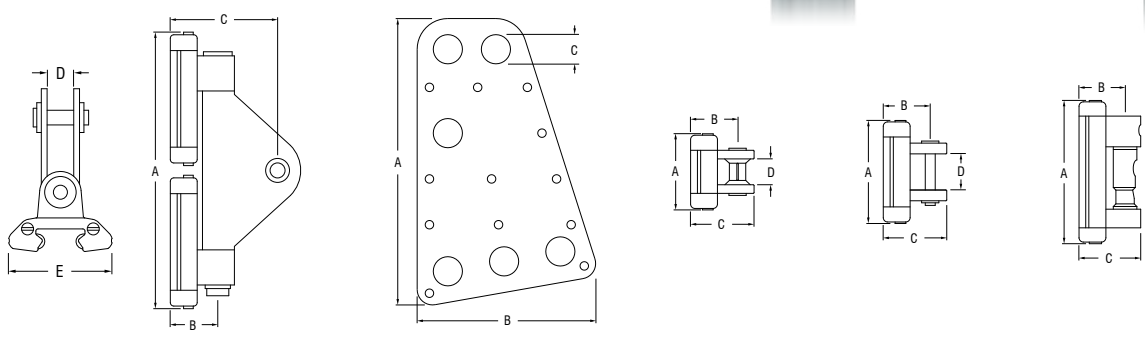

- ⬆ Long cars: Monohulls to 25m (82ft) or sail area 140m² (1507ft²).
- ⬆ Long cars: Multihulls to 18m (60ft) or sail area 105m² (1130ft²).
- ⬆ Short cars: Monohulls to 23m (75ft) or sail area 120m² (1292ft²).
- ⬆ Short cars: Multihulls to 17m (56ft) or sail area 93m² (1001ft²).

PRODUCT No.	DESCRIPTION	A	B	C	D	E	WEIGHT	A	B	C	D	E	WEIGHT
		mm	mm	mm	mm	mm	g	in	in	in	in	in	oz
Series 30 CB													
RC00011	Headboard plates (pair)	280	175	28	-	-	540	11 1/32	6 29/32	1 3/32	-	-	19.0
RC00012	Headboard plates (pair)	280	175	23	-	-	540	11 1/32	6 29/32	29/32	-	-	19.0
RC43060	Headboard car	255	43	120	20	58	1405	10 1/16	1 11/16	4 23/32	25/32	2 9/32	49.6
RC43061	Headboard car	337	43	120	20	58	1900	13 9/32	1 11/16	4 23/32	25/32	2 9/32	67.0
RC43063	Intermediate car	69	43	56	19	58	255	2 23/32	1 11/16	2 7/32	3/4	2 9/32	9.0
RC43069	Quick release batten car	119	43	56	-	58	525	4 11/16	1 11/16	2 7/32	-	2 9/32	18.5
RC43072	Reef car, pin diam. Ø11.8mm (15/32")	119	43	56	37	58	545	4 11/16	1 11/16	2 7/32	1 15/32	2 9/32	19.2
Spare Parts													
601391	Replacement pin for RC43063	-	-	-	-	-	7	-	-	-	-	-	0.2
RC00022	Replacement bush for RC43063	-	-	-	-	-	1	-	-	-	-	-	0.1

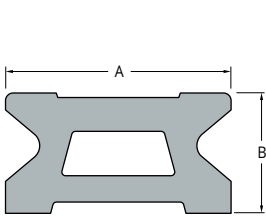
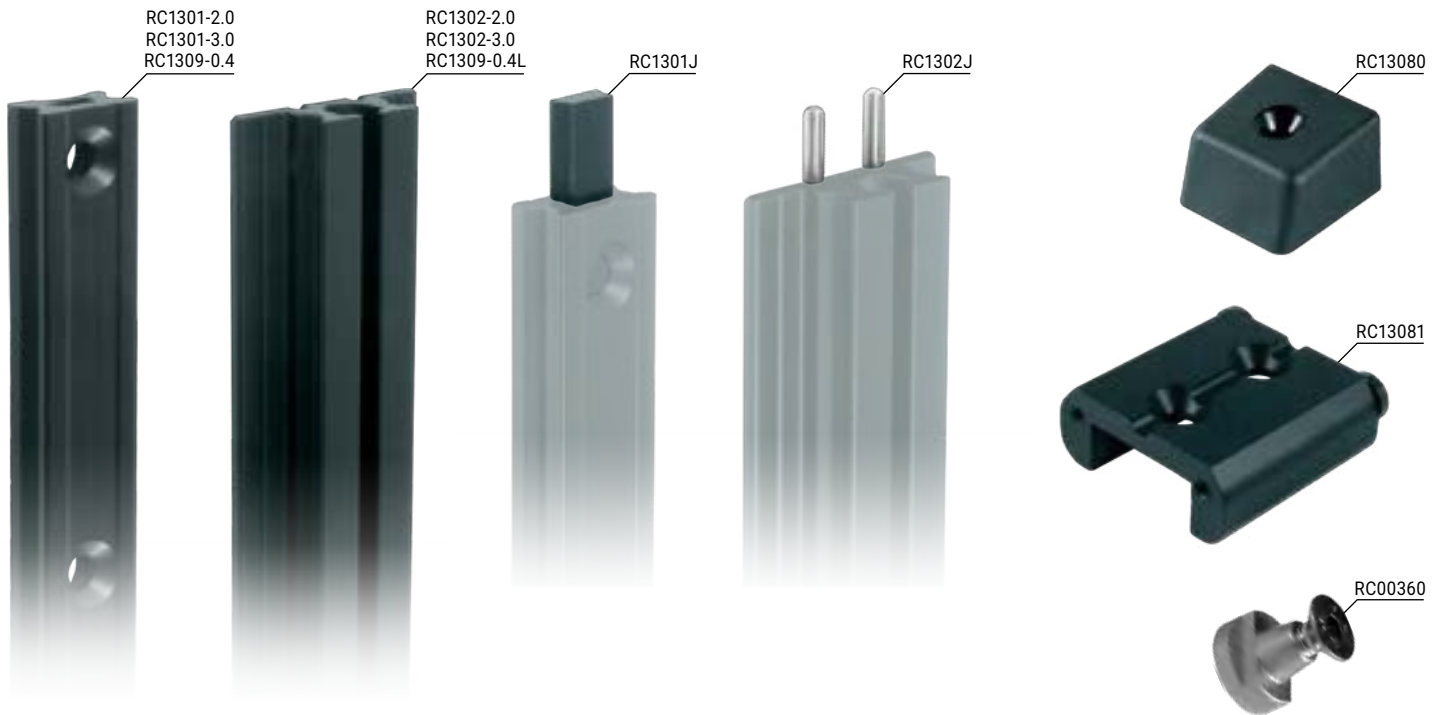

RC1301
TRACK PROFILE

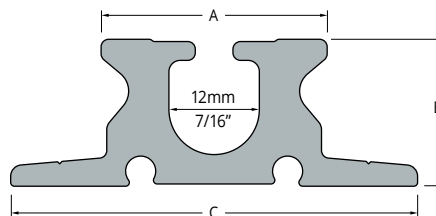

RC1302
TRACK PROFILE

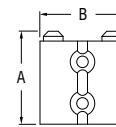

END
STOP

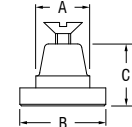

TRACK
MOUNTING SLUGS

☑ Refer to page 144 and the SUPPORT tab at www.ronstan.com for full track mounting slug details, system schematics and installation information.

TRACK FASTENINGS – M8 (5/16") countersunk head fasteners at 100mm (3 15/16") centres.

PRODUCT No.	DESCRIPTION	A	B	C	WEIGHT	A	B	C	WEIGHT
		mm	mm	mm	g	in	in	in	oz
Series 30									
RC00360	Track mounting slug, including M8 screw	12.6	22.9	18	17	1/2	29/32	23/32	0.6
RC1301-2.0*1	Track, 2025mm (79 25/32") long, black. Requires 21 track mounting slugs	30.0	16.0	-	1689	1 3/16	5/8	-	59.6
RC1301-3.0*1&2	Track, 3025mm (119 3/16") long, black. Requires 31 track mounting slugs	30.0	16.0	-	2530	1 3/16	5/8	-	89.2
RC1301J	Track joiner, acetal	-	-	-	7	-	-	-	0.2
RC1302-2.0*1	Luff groove track, 2025mm (79 25/32") long, black	30.0	19.5	54	2534	1 3/16	25/32	2 1/8	89.4
RC1302-3.0*1&2	Luff groove track, 3025mm (119 3/16") long, black	30.0	19.5	54	3795	1 3/16	25/32	2 1/8	133.9
RC1302J	Luff groove track joiner (pair)	-	-	-	5	-	-	-	0.2
RC13080	End cap, plastic, L37mm x W37mm (1 7/16" x 1 7/16")	-	-	-	27	-	-	-	1.0
RC13081	End stop, alloy	58.0	55.0	-	89	2 9/32	2 3/16	-	3.1
RC1309-0.4*1	Gate track, 400mm (15 3/4") long, black. Requires 4 track mounting slugs	30.0	16.0	-	341	1 3/16	5/8	-	12.1
RC1309-0.4L*1	Luff groove gate track, 400mm (15 3/4") long, black	30.0	19.5	54	512	1 3/16	25/32	2 1/8	18.1

*1 Silver track available - Order as RCxxxxxxS

*2 Longer track available on request.

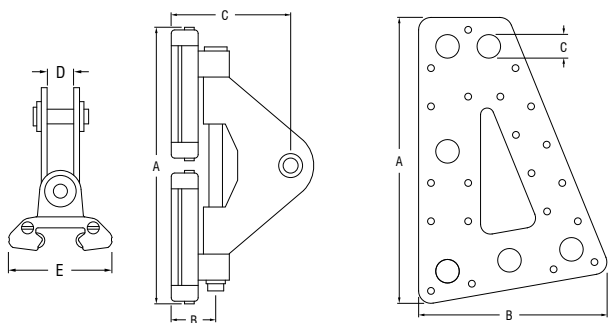
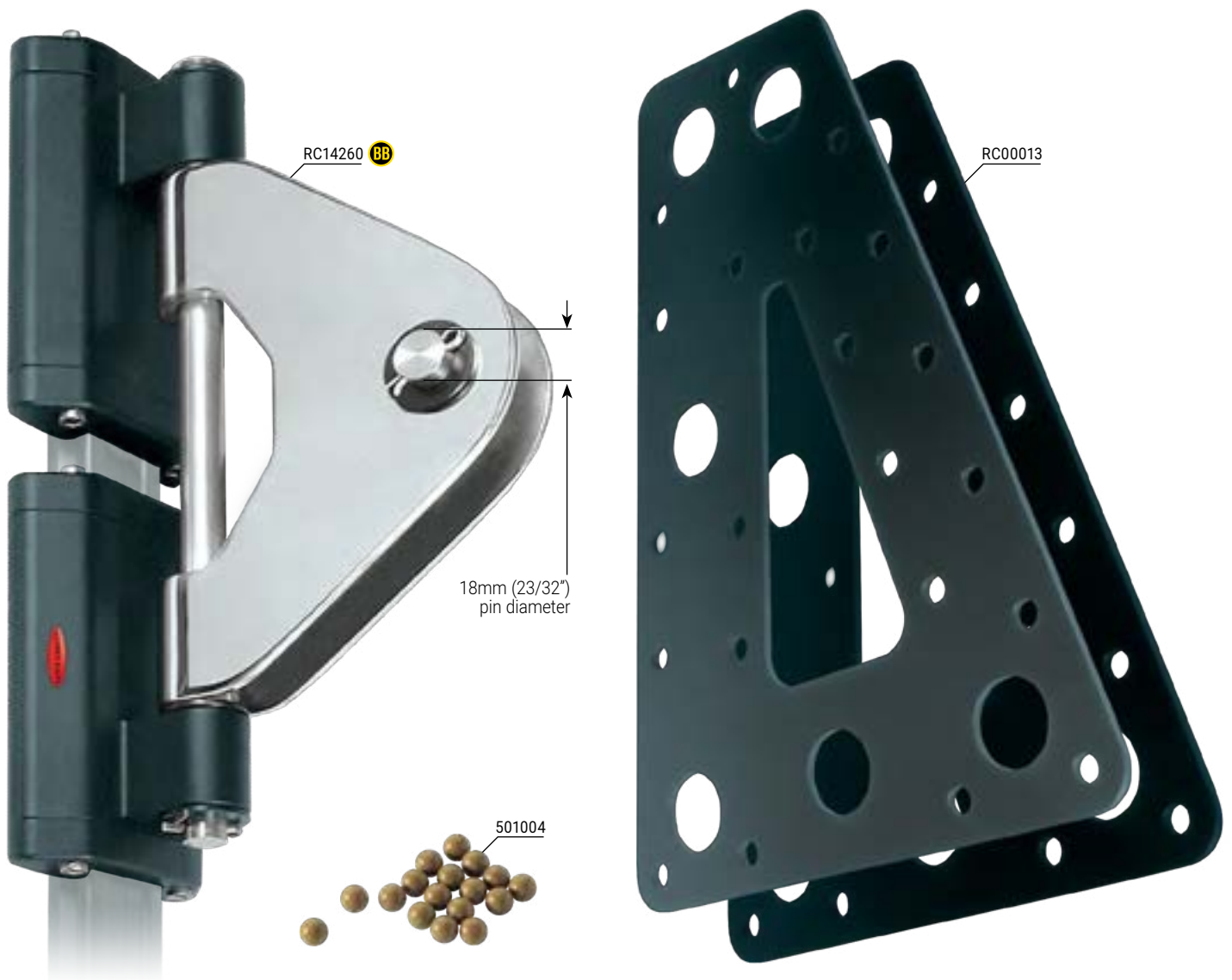

✔ Custom headboard cars, headboards and batten cars can be designed and manufactured to suit more demanding applications or individual requirements.

⬆ Monohulls to 29m (95ft) or sail area 168m² (1808ft²).

⬆ Multihulls to 22m (72ft) or sail area 125m² (1345ft²).

PRODUCT No.	DESCRIPTION	A	B	C	D	E	WEIGHT	A	B	C	D	E	WEIGHT
		mm	mm	mm	mm	mm	g	in	in	in	in	in	oz
Series 42 BB													
RC00013	Headboard plates (pair)	346	227	28	-	-	971	13 5/8	8 15/16	1 3/32	-	-	34.2
RC14260	Headboard car	335	56	152	27	96	3100	13 3/16	2 7/32	6	1 1/16	3 25/32	109.3
Spare Parts													
501004	Ball bearing, Torlon®, 9.53mm (3/8") diameter	-	-	-	-	-	1	-	-	-	-	-	0.1



✔ Custom headboard cars, headboards and batten cars can be designed and manufactured to suit more demanding applications or individual requirements.

⬆ Monohulls to 34m (112ft) or sail area 310m² (3340ft²).

⬆ Multihulls to 26m (85ft) or sail area 230m² (2450ft²).

PRODUCT No.	DESCRIPTION	A	B	C	D	E	F	WEIGHT	A	B	C	D	E	F	WEIGHT
		mm	mm	mm	mm	mm	mm	g	in	in	in	in	in	in	oz
Series 42 BB															
RC00015	Headboard plate	458	313	32	-	24	50	3250	18	12 5/16	1 1/4	-	15/16	2	115
RC14261	Headboard car	438	56	150	23	96	-	5500	17 1/4	2 7/32	6	29/32	3 25/32	-	194
Spare Parts															
501004	Ball bearing, Torlon®, 9.53mm (3/8") diameter	-	-	-	-	-	-	1	-	-	-	-	-	-	0.1



© Armare s.a.s



See page 167 for full details of batten links & receptacles

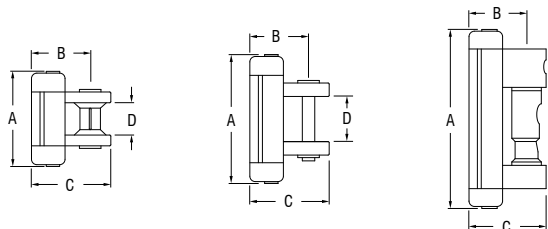

⚠ Monohulls to 29m (95ft) or sail area 168m² (1808ft²).

⚠ Multihulls to 22m (72ft) or sail area 125m² (1345ft²).

PRODUCT No.	DESCRIPTION	A	B	C	D	WEIGHT	A	B	C	D	WEIGHT
		mm	mm	mm	mm	g	in	in	in	in	oz
Series 42 BB											
RC14263	Intermediate car	85	56	71	25	420	3 11/32	2 7/32	2 13/16	1	14.8
RC14269	Quick release batten car	165	56	71	-	1035	6 1/2	2 7/32	2 13/16	-	36.5
RC14272	Reef car	170	56	71	52	1135	6 11/32	2 7/32	2 13/16	2 1/16	40.0
Spare Parts											
601369	Replacement pin for RC14263	-	-	-	-	18	-	-	-	-	0.6
RC00023	Replacement bush for RC14263	-	-	-	-	3	-	-	-	-	0.1

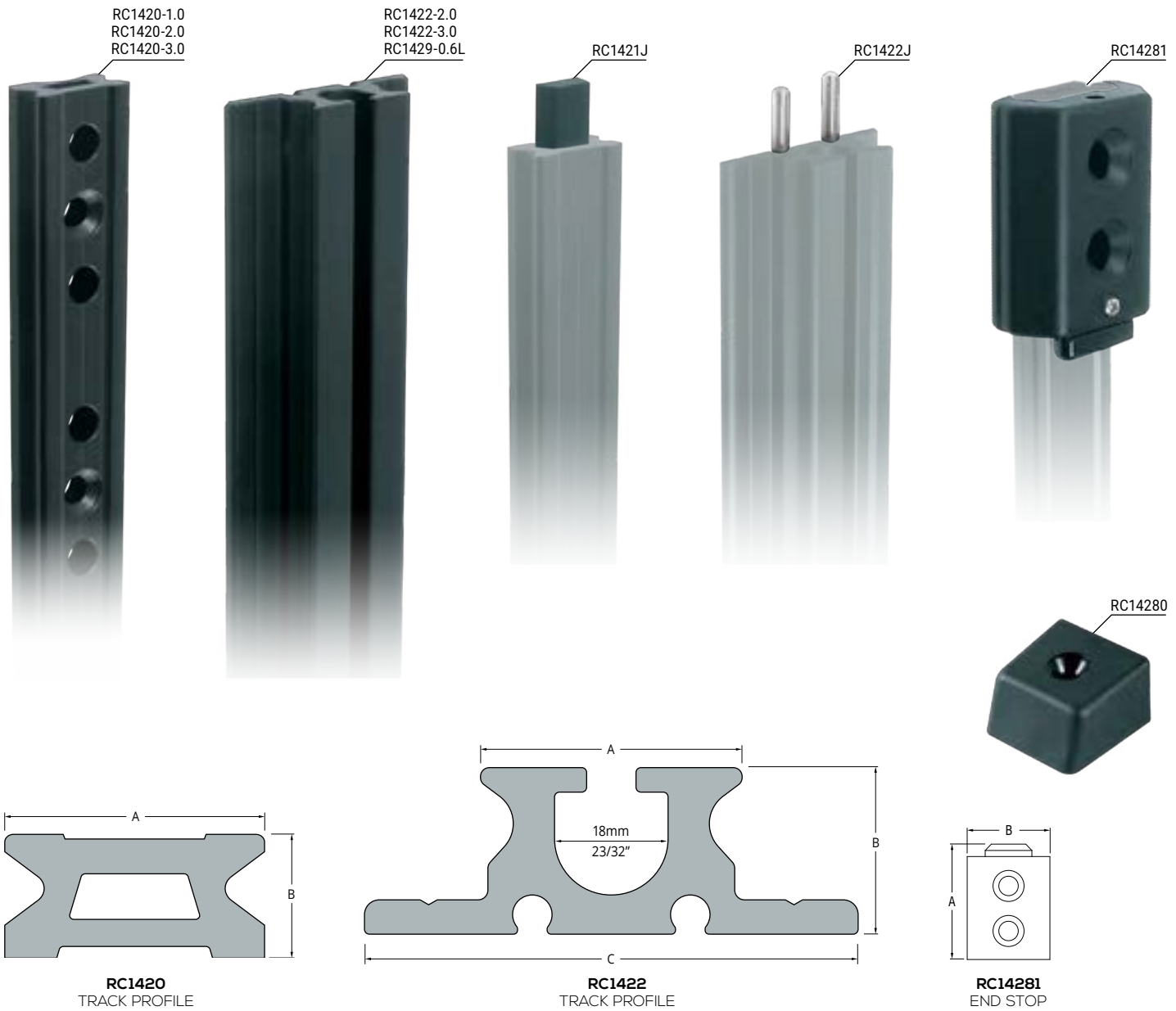

☑ Refer to the SUPPORT tab at www.ronstan.com for system schematics and installation information.

TRACK FASTENINGS – M10 (3/8") countersunk head fasteners at 100mm (3 15/16") centres.

PRODUCT No.	DESCRIPTION	A	B	C	WEIGHT	A	B	C	WEIGHT
		mm	mm	mm	g	in	in	in	oz
Series 42									
RC1420-1.0*1	Track, 996mm (39 3/16") long, black	42	21	-	1430	1 21/32	13/16	-	50.5
RC1420-2.0*1	Track, 1996mm (78 9/16") long, black	42	21	-	2860	1 21/32	13/16	-	100.9
RC1420-3.0*1&2	Track, 2996mm (117 15/16") long, black	42	21	-	4290	1 21/32	13/16	-	151.3
RC1421J	Track joiner, acetal	-	-	-	17	-	-	-	0.6
RC1422-2.0*1	Luff groove track, 2025mm (79 23/32") long, black	42	27	80	4758	1 21/32	1 1/16	3 5/32	167.8
RC1422-3.0*1&2	Luff groove track, 3025mm (119 3/32") long, black	42	27	80	7108	1 21/32	1 1/16	3 5/32	250.7
RC1422J	Luff groove track joiner (pair)	-	-	-	10	-	-	-	0.4
RC14280	End cap, plastic, L50mm x W49mm (2" x 2")	-	-	-	20	-	-	-	0.7
RC14281	End stop, alloy	100	75	-	345	4	2 15/16	-	12.2
RC1429-0.6*1	Gate track, 650mm (25 19/32") long, black	42	21	-	905	1 21/32	13/16	-	31.9
RC1429-0.6L*1	Luff groove gate track, 650mm (25 19/32") long, black	42	27	80	1525	1 21/32	1 1/16	3 5/32	53.8

* 1 Silver track available - Order as RCxxxxxxS

* 2 Longer track available on request.



18mm (23/32") pin diameter
Bushed to 32mm (1 1/4") diameter

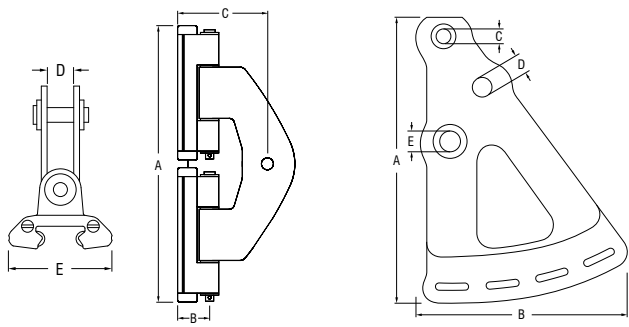

✔ Custom headboard cars, headboards and batten cars can be designed and manufactured to suit more demanding applications or individual requirements.

⚙ Monohulls to 45m (148ft) or sail area 400m² (4306ft²).

⚙ Multihulls to 33m (110ft) or sail area 300m² (3229ft²).

PRODUCT No.	DESCRIPTION	A	B	C	D	E	WEIGHT	A	B	C	D	E	WEIGHT
		mm	mm	mm	mm	mm	g	in	in	in	in	in	oz
Series 55 BB													
RC00014	Headboard plate	490	315	25.4	30.0	34.4	6880	19 5/16	12 7/16	1	1 5/32	1 5/16	242.7
RC15560	Headboard car	605	74	200	34	126	15160	23 13/16	2 15/16	7 7/8	1 5/16	5	534.8
Spare Parts													
501005	Ball bearing, Torlon®, 12.7mm (1/2") diameter	-	-	-	-	-	2	-	-	-	-	-	0.2



© Contest Yachts

✔ Custom headboard cars, headboards and batten cars can be designed and manufactured to suit more demanding applications or individual requirements.

⬆ Monohulls to 52m (170ft) or sail area 700m² (7500ft²).

⬆ Multihulls to 39m (128ft) or sail area 525m² (5650ft²).

PRODUCT No.	DESCRIPTION	A	B	C	D	E	WEIGHT	A	B	C	D	E	WEIGHT
		mm	mm	mm	mm	mm	g	in	in	in	in	in	oz
Series 55 BB													
RC15561	Headboard car	710	74	204	34	126	18300	28	2 15/16	8	1 5/16	5	647.0

SERIES 55 TRACK

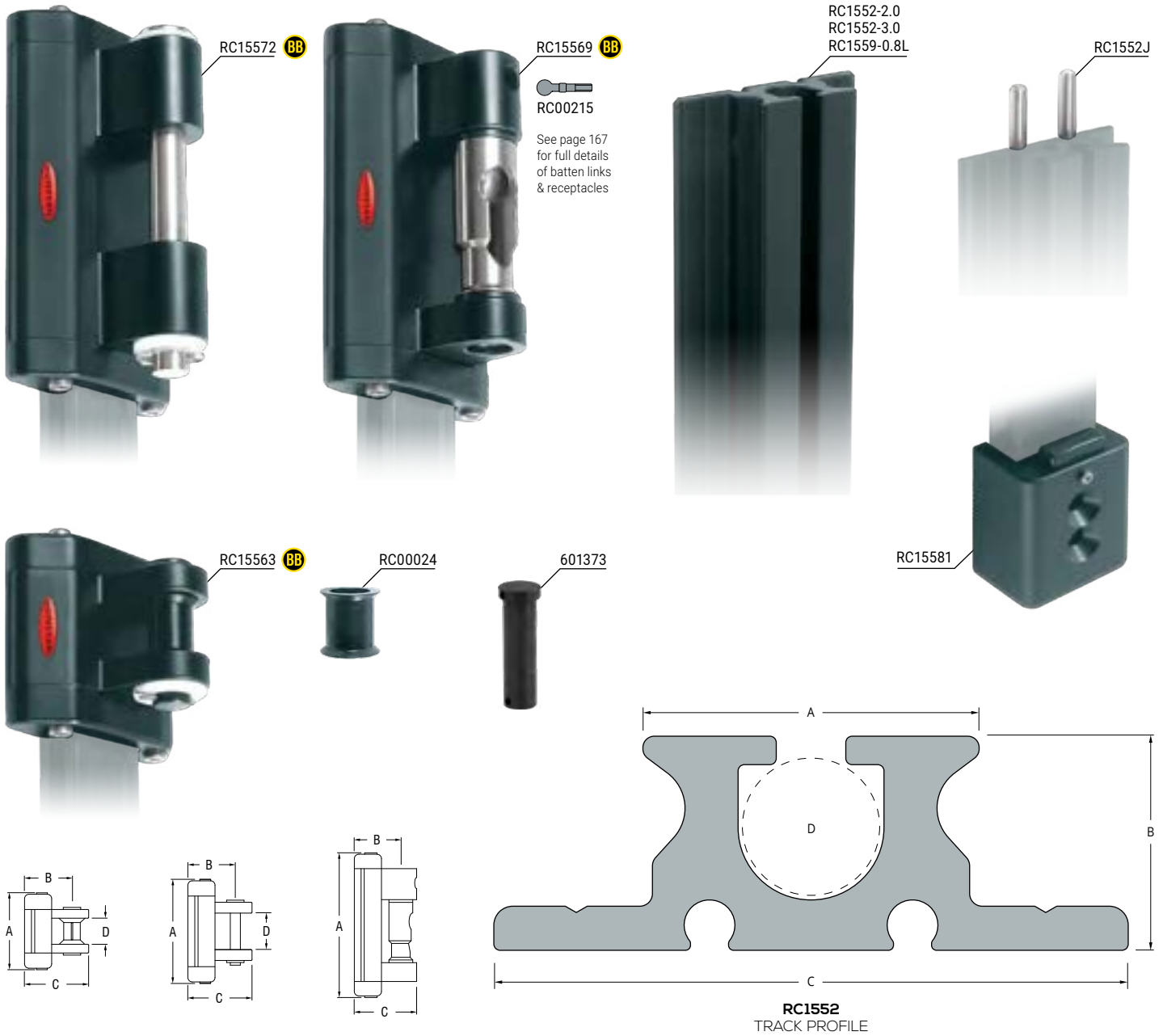

- ☑ Refer to the SUPPORT tab at www.ronstan.com for system schematics and installation information.
- ☑ Refer to page 128 for details of standard Series 55 track.

- ⬆ Monohulls to 45m (148ft) or sail area 400m² (4306ft²).
- ⬆ Multihulls to 33m (110ft) or sail area 300m² (3229ft²).

TRACK FASTENINGS – M10 (3/8") countersunk head fasteners at 100mm (3 15/16") centres.

PRODUCT No.	DESCRIPTION	A	B	C	D	WEIGHT	A	B	C	D	WEIGHT
		mm	mm	mm	mm	g	in	in	in	in	oz
Series 55											
RC15563	Intermediate car	128	74	94	37	1151	5 1/6	2 15/16	3 11/16	1 7/16	40.6
RC15569	Quick release batten car	206	74	94	-	2342	8 1/8	2 15/16	3 11/16	-	82.6
RC15572	Reef car	216	74	94	60	3000	8 1/2	2 15/16	3 11/16	2 3/8	105.8
RC15581	End stop, alloy, L110mm x W76mm (4 5/16" x 3")	-	-	-	-	477	-	-	-	-	16.8
RC1552-2.0*1	Luff groove track, 2025mm (79 23/32") long, black	55	37.5	108	24	8856	2 5/32	1 15/32	4 1/4	15/16	312.4
RC1552-3.0*1&2	Luff groove track, 3025mm (119 3/32") long, black	55	37.5	108	24	13284	2 5/32	1 15/32	4 1/4	15/16	468.6
RC1552J	Luff groove track joiners (pair)	-	-	-	-	49	-	-	-	-	1.7
RC1559-0.8L*1	Luff groove gate track, 800mm (31 1/2") long, black	55	37.5	108	24	3542	2 5/32	1 15/32	4 1/4	15/16	124.9
Spare Parts											
601373	Replacement pin for RC15563	-	-	-	-	33	-	-	-	-	1.2
RC00024	Replacement bush for RC15563	-	-	-	-	130	-	-	-	-	4.6

*1 Silver track available - Order as RCxxxxxxxS
 *2 Longer track available on request.

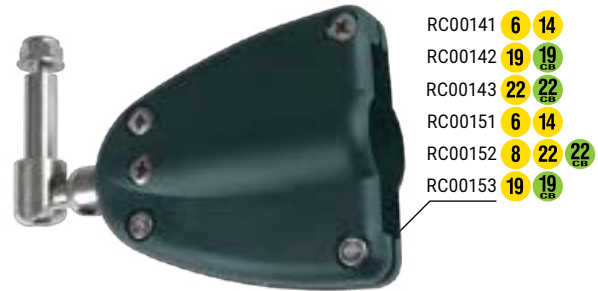
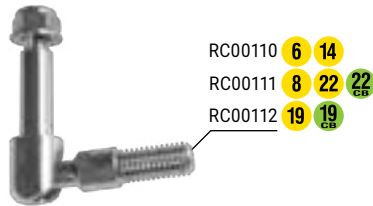
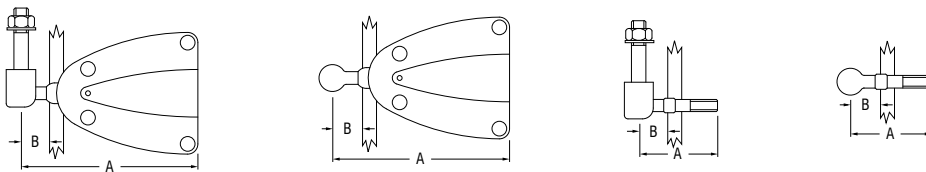
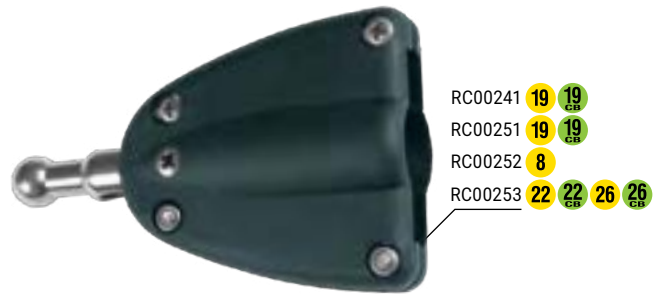
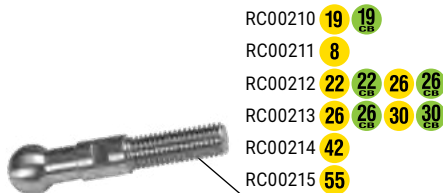
STANDARD

QUICK RELEASE

Numbers in yellow/green badges refer to the batten car system(s) that the receptacle link suits

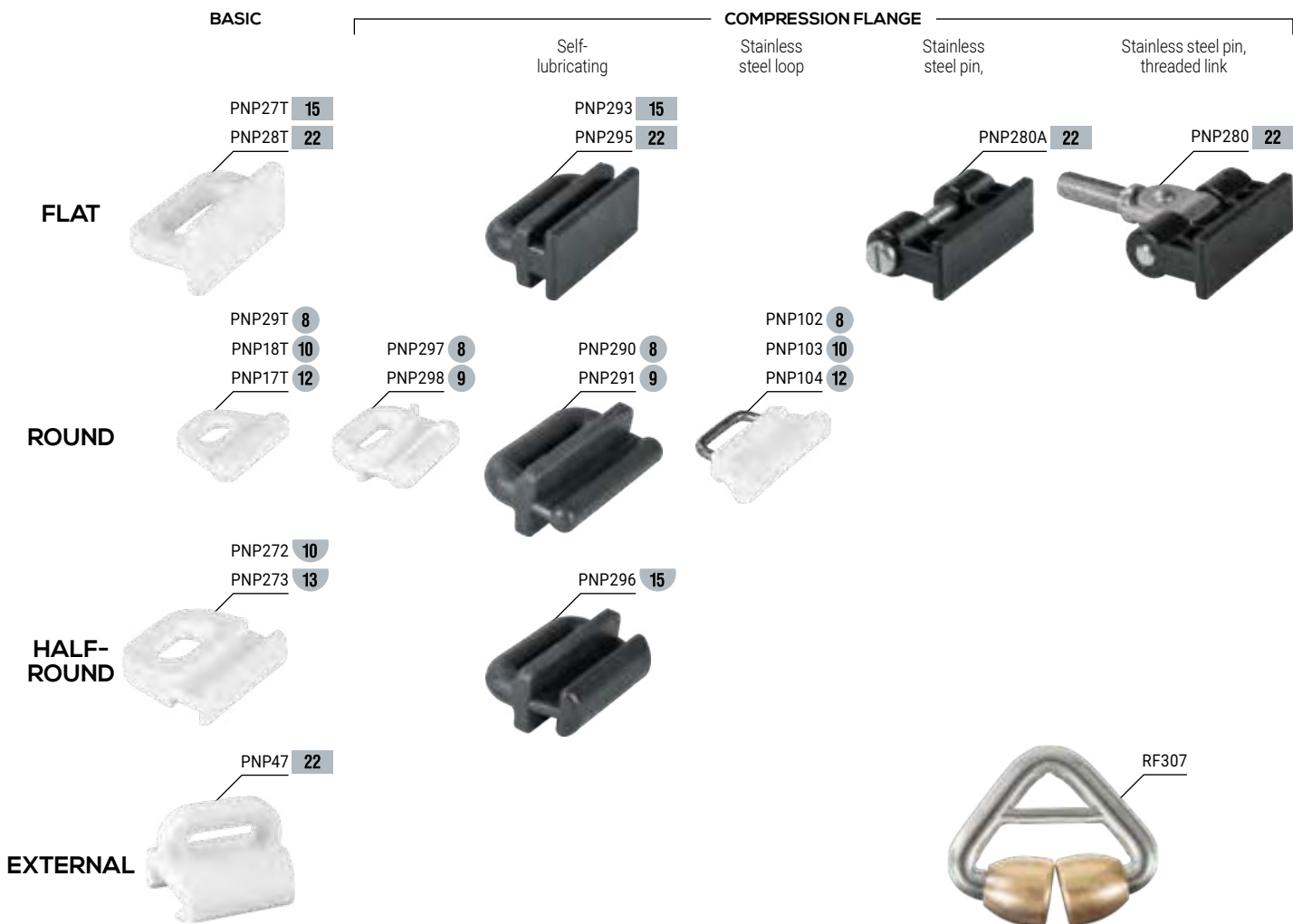
PRODUCT No.	DESCRIPTION	A mm	B mm	WEIGHT g	A in	B in	WEIGHT oz
Standard Batten Receptacle Links							
RC00110	Batten receptacle link, M10, suits S14, S6 Ballslide™	58	19	61	2 9/32	3/4	2.2
RC00111	Batten receptacle link, M10, suits S22, S8 Ballslide™	58	19	81	2 9/32	3/4	2.9
RC00112	Batten receptacle link, M10, suits S19	58	19	77	2 9/32	3/4	2.7
RC00140	Batten receptacle, nylon, suits 40mm (1 1/2") flat & 14mm (9/16") diameter round battens	-	-	61	-	-	2.2
RC00141	Batten receptacle link with RC00140 receptacle, suits S14, S6 Ballslide™	92	15	105	3 5/8	19/32	3.7
RC00142	Batten receptacle link with RC00140 receptacle, suits S19	94	17	122	3 23/32	21/32	4.3
RC00143	Batten receptacle link with RC00140 receptacle, suits S22	96	19	116	3 25/32	3/4	4.1
RC00150	Batten receptacle, nylon, suits 50mm (2") flat & 18mm (3/4") diameter round battens	-	-	115	-	-	4.1
RC00151	Batten receptacle link, with RC00150 receptacle, suits S14, S6 Ballslide™	110	15	170	4 11/32	19/32	6.0
RC00152	Batten receptacle link, with RC00150 receptacle, suits S22, S8 Ballslide™	116	19	190	4 9/16	3/4	6.7
RC00153	Batten receptacle link, with RC00150 receptacle, suits S19	114	17	188	4 1/2	21/32	6.6
PNP162	Batten receptacle, vernier adjuster, suits 30mm (1 3/16") x 10mm (13/32") flat battens, suits M10 link	-	-	152	-	-	5.4
Quick Release Batten Receptacle Links							
RC00210	Batten receptacle link 11.5mm (7/16") diameter ball, M10, suits S19	58	19	37	2 9/32	3/4	1.3
RC00211	Batten receptacle link 13.0mm (1/2") diameter ball, M10, suits S8 Ballslide™	60	19	42	2 3/8	3/4	1.5
RC00212	Batten receptacle link 15.4mm (5/8") diameter ball, M10, suits S22, S26	62	19	49	2 7/16	3/4	1.7
RC00213	Batten receptacle link 15.4mm (5/8") diameter ball, M12, suits S26, S30	62	19	59	2 7/16	3/4	2.1
RC00214	Batten receptacle link 19.8mm (3/4") diameter ball, M14, suits S42	100	26	118	3 15/16	1 1/32	4.2
RC00215	Batten receptacle link 22.9mm (7/8") diameter ball, M16, suits S55	101	33	180	4	1 5/16	6.3
RC00241	Batten receptacle link 11.5mm (7/16") diameter ball, with RC00140 receptacle, suits S19	94	17	82	3 23/32	21/32	2.9
RC00251	Batten receptacle link 11.5mm (7/16") diameter ball, with RC00150 receptacle, suits S19	114	17	147	4 1/2	21/32	5.2
RC00252	Batten receptacle link 13.0mm (1/2") diameter ball, with RC00150 receptacle, suits S8 Ballslide™	116	19	152	4 9/16	3/4	5.4
RC00253	Batten receptacle link 15.4mm (5/8") diameter ball, with RC00150 receptacle, suits S22, S26	116	19	165	4 9/16	3/4	5.8



Numbers in grey badges refer to nominal diameter (round & semi-round), or width (flat) in millimetres.

PRODUCT No.	DESCRIPTION	WEIGHT g	WEIGHT oz
Slides, Flat			
PNP27T	Sail slide, flat, 15.2mm (5/8") wide x 32mm (1 1/4") long, 20mm (3/4") webbing slot	4	0.1
PNP293*	Sail slide, flat, 15.3mm (5/8") wide, 45mm (1 3/4") long, 25mm (1") webbing slot, flange	12	0.4
PNP280	Sail slide, flat, 21.7mm (7/8") wide, 57mm (2 1/4") long, M10 link	98	3.5
PNP280A	Sail slide, flat, 21.7mm (7/8") wide, 64mm (2 1/2") long, 20mm (3/4") webbing slot, stainless steel pin	42	1.5
PNP295*	Sail slide, flat, 21.9mm (7/8") wide, 45mm (1 3/4") long, 25mm (1") webbing slot, flange	14	0.5
PNP28T	Sail slide, flat, 23mm (7/8") wide x 42mm (1 5/8") long, 25mm (1") webbing slot	8	0.3
Slides, Round			
PNP290*	Sail slide, round, 7.4mm (5/16") diameter x 45mm (1 3/4") long, 25mm (1") webbing slot, flange	12	0.4
PNP297	Sail slide, round, 7.5mm (5/16") diameter x 28mm (1 1/8") long, 16mm (5/8") webbing slot, flange	4	0.1
PNP29T	Sail slide, round, 7.8mm (5/16") diameter x 32mm (1 1/4") long, 12mm (1/2") webbing slot, flange	2	0.1
PNP298	Sail slide, round, 8.9mm (3/8") diameter x 28mm (1 1/8") long, 16mm (5/8") webbing slot, flange	6	0.2
PNP102	Sail slide, round, 8.0mm (5/16") diameter x 42mm (1 5/8") long, 20mm (3/4") webbing slot, flange, stainless steel loop	8	0.3
PNP291*	Sail slide, round, 9.1mm (3/8") diameter x 45mm (1 3/4") long, 25mm (1") webbing slot, flange	12	0.4
PNP18T	Sail slide, round, 9.8mm (3/8") diameter x 40mm (1 9/16") long, 16mm (5/8") webbing slot, flange	4	0.1
PNP103	Sail slide, round, 9.8mm (3/8") diameter x 45mm (1 3/4") long, 20mm (3/4") webbing slot, flange, stainless steel loop	10	0.4
PNP17T	Sail slide, round, 11.7mm (1/2") diameter x 39mm (1 1/2") long, 16mm (5/8") webbing slot	4	0.1
PNP104	Sail slide, round, 12.3mm (1/2") diameter x 45mm (1 3/4") long, 20mm (3/4") webbing slot, flange, stainless steel pin	11	0.4
Slides, Half-Round			
PNP272	Sail slide, half-round, 10.1mm (7/16") wide x 32mm (1 1/4") long, 16mm (5/8") webbing slot, flange, suits Seldën profile	6	0.2
PNP273	Sail slide, half-round, 12.7mm (1/2") wide, 32mm (1 1/4") long, 16mm (5/8") webbing slot, flange, suits Seldën profile	8	0.3
PNP296*	Sail slide, half-round, 15mm (5/8") wide, 45mm (1 3/4") long, 25mm (1") webbing slot, flange, suits Seldën profile	14	0.5
Slide, External			
PNP47	Sail slide, external, 23.2mm (7/8") internal width x 33mm (1 1/4") long, 20mm (3/4") webbing slot	10	0.4
Sail Feeder			
RF307	Headsail Pre-Feeder, suits up to 7mm luff tapes	67	2.4

*Self-lubricating



- ✔ Products are supplied with screws as shown.
- ✔ Larger batten pocket protectors and adjusters are slotted at luff end to allow webbing attachment to slides or cars.

- ✔ PNP155 vernier batten adjuster allows fine tuning of batten compression. Low gearing of the vernier screw permits fingertip adjustment, and precise settings are easily repeated with the aid of the graduated window.

PRODUCT No.	DESCRIPTION	WEIGHT g	WEIGHT oz
Hanks			
PNP14	Twist on hank, suits 3mm (1/8") wire, 31mm (1 1/4") long	5	0.2
PNP14A	Twist on hank, suits 4mm (5/32") wire, 34mm (1 11/32") long	6	0.2
PNP14B	Twist on hank, suits 5mm (3/16") wire, 38mm long (1/2") long	7	0.2
PNP88A	Piston hank, suits 6.4mm (1/4") diameter wire, 50mm (2") long	8	0.3
PNP88B	Piston hank, suits 8.0mm (5/16") diameter wire, 72mm (2 7/8") long	15	0.5
PNP88C	Piston hank, suits 11.2mm (7/16") diameter wire, 75mm (3") long	22	0.8
Sail Shackle			
PNP63	Sail shackle, screw-on, 12mm (1/2") x 8mm (5/16") internal clearance, suits slides PNP18T, PNP27T & PNP29T	2	0.1
PNP64	Sail shackle, snap-on, 16mm (5/8") x 11mm (7/16") internal clearance	4	0.1
PNP65	Sail shackle, snap-on, 29mm (1 1/8") x 9mm (3/8") internal clearance	6	0.2
PNP81A	Sail shackle, snap-on, 11mm (7/16") x 8mm (5/16") internal clearance, suits slides PNP18T, PNP27T & PNP29T	2	0.1
PNP81B	Sail shackle, snap-on, 12.7mm (1/2") x 8mm (5/16") internal clearance, suits slides PNP17T, PNP18T & PNP28T	4	0.1
PNP106	Sail shackle, screw-on, 16mm (5/8") x 10mm (3/8") internal clearance	8	0.3
PNP107	Sail shackle, screw-on, 28mm (1 1/8") x 9mm (3/8") internal clearance	6	0.2
PNP108	Sail shackle, screw-on, 29mm (1 1/8") x 13mm (1/2") internal clearance	8	0.3
Batten Pocket Protectors			
PNP83	Batten pocket protector, suits battens up to 50mm (1 31/32") x 6mm (1/4")	17	0.6
PNP87	Batten pocket protector, suits battens up to 16mm (5/8") x 4mm (5/32")	9	0.3
PNP105	Batten pocket protector, suits batten ends up to 40mm (1 1/2") x 5mm (3/16")	17	0.6
PNP147	Batten pocket protector, suits battens up to 50mm (1 31/32") x 5mm (3/16")	56	2.0
PNP148	Batten pocket protector, heavy duty glass reinforced nylon, suits battens up to 50mm (1 31/32") x 8mm (5/16")	90	3.2
Vernier Batten Adjuster			
PNP155	Batten receptacle, vernier adjuster, suits 22mm (7/8") x 10mm (13/32") flat battens, or round 13mm (1/2") diameter	148	5.2
PNP162	Batten receptacle, vernier adjuster, suits 30mm (1 3/16") x 10mm (13/32") flat battens, suits M10 link	152	5.4

HOOKS & CLIPS



PRODUCT No.	DESCRIPTION	WEIGHT g	WEIGHT oz
Tube Clips			
PNP43A	Tube clip, suits 44mm (1 3/4") diameter tube. Requires 2 x 4mm (5/35") fasteners	15	0.6
PNP43B	Tube clip, suits 38mm (1 1/2") diameter tube. Requires 2 x 4mm (5/35") fasteners	10	0.4
PNP43C	Tube clip, suits 32mm (1 1/4") diameter tube. Requires 2 x 4mm (5/32") fasteners	7	0.3
PNP43D	Tube clip, suits 25mm (1") diameter tube. Requires 2 x 4mm (5/32") fasteners	4	0.1
PNP43E	Tube clip, suits 16mm (5/8") diameter tube. In line fastening. Requires 2 x 3mm (1/8") fasteners	4	0.1
PNP43F	Tube clip, suits 19mm (3/4") diameter tube. In line fastening. Requires 2 x 3mm (1/8") fasteners	4	0.1
Snap Hooks			
PNP13A	Snap hook, narrow. 10mm (3/8") eye clearance. 8mm (5/16") hook clearance	5	0.2
PNP13B	Snap hook, narrow. 8mm (5/16") eye clearance. 5mm (3/16") hook clearance	3	0.1
PNP16	Flag/sister clip. 13mm (1/2") eye clearance	5	0.2
PNP16A	Flag/sister clip. 8mm (5/16") eye clearance	6	0.2
PNP16B	Flag/sister clip. 4.7mm (3/16") eye clearance	2	0.1
PNP56	Shock cord hook. Suits 7mm (1/4") diameter shock cord. 8mm (5/16") hook clearance	12	0.4
PNP56B	Shock cord hook. Suits 5mm (3/16") diameter shock cord. 10mm (3/8") hook clearance	6	0.2
PNP387	Shock cord hook. Suits 3-5mm (1/8" - 3/16") diameter shock cord. 6mm (1/4") hook clearance	3	0.1
PNP388	Shock cord hook. Suits 4-6mm (5/32" - 1/4") diameter shock cord. 9mm (11/32") hook clearance	8	0.3
PNP389	Shock cord hook. Suits 6-8mm (1/4" - 5/16") diameter shock cord. 10mm (3/8") hook clearance	10	0.3
Fixed Hooks			
PNP3	Hook, 5mm (3/16") hook clearance. 52mm (2") long. Requires 2 x 4mm (5/32") fasteners	3	0.1
PNP5	Hook, 8mm (5/16") hook clearance. 75mm (3") long. Requires 2 x 4mm (5/32") fasteners	8	0.3
PNP20	Tubular jam cleat. Suits up to 4mm (5/32") diameter line. Suits 2 x 5mm (3/16") fasteners	4	0.1
PNP45	Hook, 11mm (7/16") hook clearance. Requires 2 x 4mm (5/32") fasteners	3	0.1
PNP84	Hook, 5mm (3/16") hook clearance. Requires 2 x 5mm (3/16") fasteners	5	0.2
PNP38	Line hanger clip, suits 5mm (3/16") diameter shock cord retaining loop. Knots are concealed in body. Requires 2 x 4mm (5/32") fasteners	8	0.3
RF6010C	Utility line hangers (2 pack), suits 5mm (3/16") diameter shock cord retaining loop. Requires 2 x 5mm (3/16") fasteners	7	0.2
Rope Clips			
PNP576-2	Rope clip, lash-on. Suits 5-10mm (3/16" - 3/8") diameter rope	12	0.4
PNP577-2	Rope clip, cable tie-on. Suits 5-10mm (3/16" - 3/8") diameter rope	12	0.4
PNP578-2	Rope clip, lash-on. Suits 8-14mm (5/16" - 9/16") diameter rope	24	0.8
PNP579-2	Rope clip, cable tie-on. Suits 8-14mm (5/16" - 9/16") diameter rope	24	0.8



PRODUCT No.	DESCRIPTION	WEIGHT g	WEIGHT oz
Rings			
PNP11	Ring, 32mm (1 1/4") ID x 6.4mm (1/4") bar diameter	4	0.1
PNP52C	Ring, 19mm (3/4") ID x 4.8mm (3/16") bar diameter	2	0.1
PNP53E	Ring, 44mm (1 3/4") ID x 9.5mm (3/8") bar diameter	13	0.5
PNP265	Ring, 22mm (7/8") ID x 7.6mm (5/16") bar diameter	5	0.2
PNP266	Ring, 28mm (1 1/8") ID x 9.1mm (23/64") bar diameter	10	0.3
Thimbles			
PNP78	Thimble, suits 8mm (5/16") diameter rope. 13mm (1/2") internal clearance	6	0.2
PNP78A	Thimble, suits 10mm (3/8") diameter rope. 15mm (5/8") internal clearance	5	0.2
PNP78B	Thimble, suits 12mm (1/2") diameter rope. 22mm (7/8") internal clearance	10	0.4
PNP78C	Thimble, suits 16mm (5/8") diameter rope. 30mm (1 3/16") internal clearance	13	0.5
Fairleads			
PNP1	Fairlead, 19mm (3/4") ID, white. Requires 2 x 3mm (1/8") fasteners	27	1.0
PNP33	Fairlead, 11mm (7/16") ID, white. Requires 2 x 4mm (5/32") fasteners	4	0.1
PNP33BLK	Fairlead, 11mm (7/16") ID, black. Requires 2 x 4mm (5/32") fasteners	4	0.1
PNP48	Fairlead, 5mm (3/16") clearance, black. Requires 2 x 3mm (1/8") fasteners	4	0.1
PNP49	Fairlead, 10mm (3/8") clearance, white. Requires 2 x 3mm (1/8") fasteners	16	0.6
PNP120	Fairlead, 6.5mm (1/4") ID, stainless steel lined, black. Requires 2 x 3mm (1/8") fasteners	8	0.3
PNP120A	Fairlead, 6mm (3/16") ID, white. Requires 2 x 3mm (1/8") fasteners	2	0.1
PNP121	Fairlead, 8mm (5/16") ID, stainless steel lined, black. Requires 2 x 4mm (5/32") fasteners	8	0.3
PNP121A	Fairlead, 8mm (5/16") ID, white. Requires 2 x 4mm (5/32") fasteners	4	0.1
PNP122	Fairlead, 11.5mm (7/16") ID, stainless steel lined, black. Requires 2 x 5mm (3/16") fasteners	10	0.4
PNP122A	Fairlead, 10mm (3/8") ID, white. Requires 2 x 5mm (3/16") fasteners	6	0.2
PNP123	Fairlead, 13.5mm (1/2") ID, stainless steel lined, black. Requires 2 x 5mm (3/16") fasteners	16	0.5
PNP123A	Fairlead, 11.5mm (7/16") ID, white. Requires 2 x 5mm (3/16") fasteners	9	0.3
PNP124	Fairlead, 16mm (5/8") ID, stainless steel lined, black. Requires 2 x 5mm (3/16") fasteners	24	0.8
PNP124A	Fairlead, 15mm (9/16") ID, white. Requires 2 x 5mm (3/16") fasteners	12	0.4
RF9	Fairlead, 7mm (9/32") ID, black. Requires 2 x 4mm (5/32") fasteners	5	0.2
RF59	Fairlead, 14mm (9/16") ID, stainless steel lined, black. Requires 2 x 5mm (3/16") fasteners	17	0.6
RF374	Fairlead, 12mm x 40mm (1/2" x 1 1/2") ID, black. Requires 1 x 5mm (3/16") & 1 x 6mm (1/4") fasteners	20	0.7
RF2358	Fairlead, 16mm (5/8") ID, stainless steel lined, black. Requires 2 x 5mm (3/16") fasteners	26	0.9

BUSHES

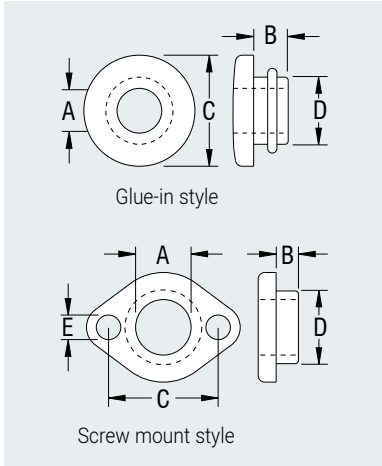
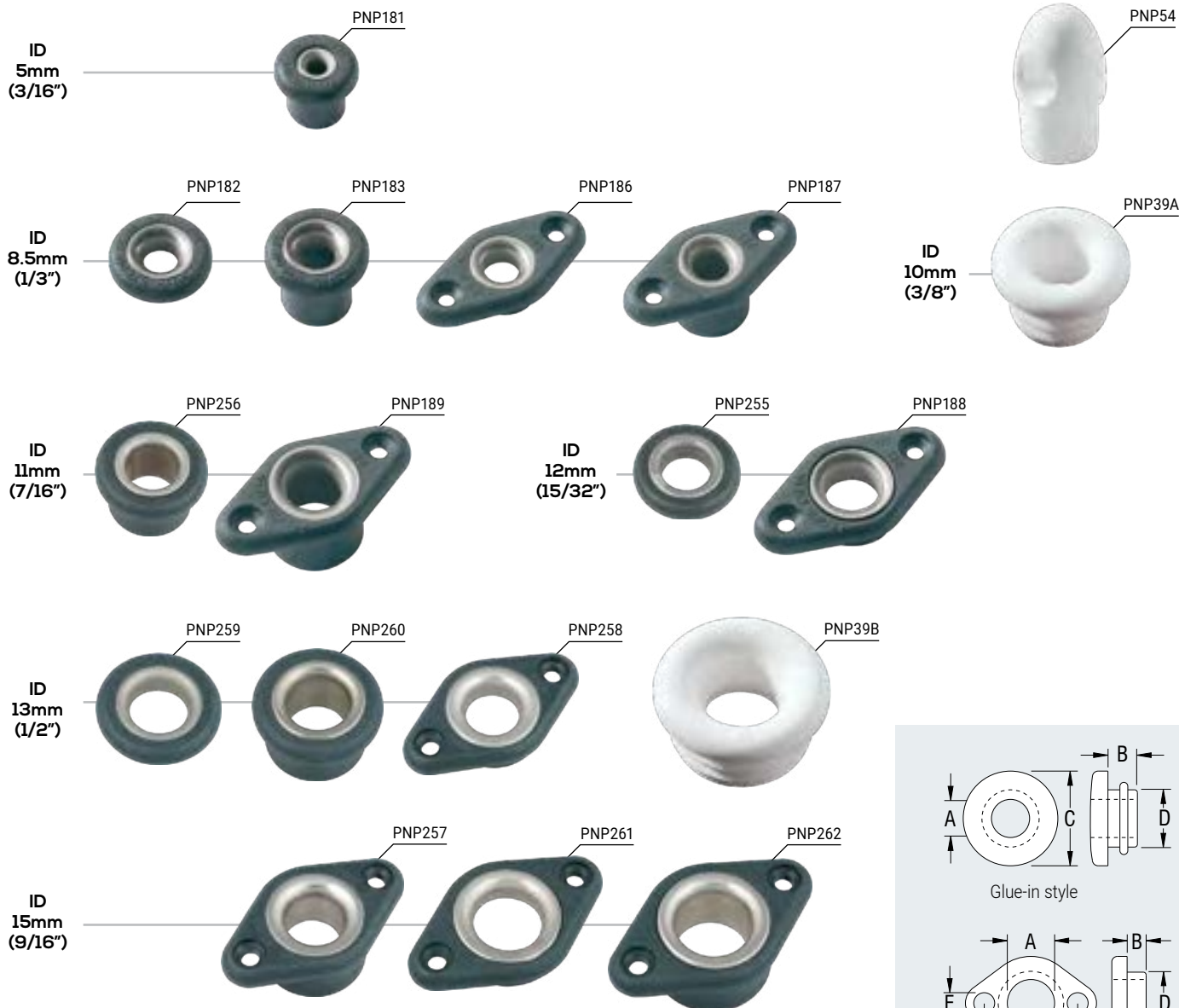

✓ Nylon bushes provide chafe protection where lines pass through decks, bulkheads or spars. They are available to suit various line diameters and deck thicknesses.

PRODUCT No.	DESCRIPTION	A mm	B mm	C mm	D mm	E mm	WEIGHT g	A in	B in	C in	D in	E in	WEIGHT oz
Bushes													
PNP54	Staunched cap. Suits 22.2mm (7/8") ID tube	-	-	-	-	-	12	-	-	-	-	-	0.4
PNP181	Plastic bush, glue-in, stainless steel lined	5.0	14.0	18.5	13.0	-	5	3/16	9/16	3/4	1/2	-	0.2
PNP182	Plastic bush, glue-in, stainless steel lined	8.5	6.0	22.0	16.0	-	4	11/32	1/4	7/8	5/8	-	0.1
PNP183	Plastic bush, glue-in, stainless steel lined	8.5	14.0	22.0	16.0	-	7	11/32	9/16	7/8	5/8	-	0.2
PNP186	Plastic bush, screw mount, stainless steel lined	8.5	5.0	28.0	16.0	3.0	5	11/32	9/32	1 3/32	5/8	1/8	0.2
PNP187	Plastic bush, screw mount, stainless steel lined	8.5	14.0	28.0	16.0	3.0	8	11/32	9/16	1 3/32	5/8	1/8	0.3
PNP39A	Plastic bush, glue-in	10.0	13.0	22.0	16.0	-	3	3/8	1/2	7/8	5/8	-	0.1
PNP188	Plastic bush, screw mount, stainless steel lined	12.0	6.0	31.0	20.0	3.0	5	15/32	1/4	1 7/32	25/32	1/8	0.2
PNP189	Plastic bush, screw mount, stainless steel lined	11.0	14.0	31.0	20.0	3.0	10	7/16	9/16	1 7/32	25/32	1/8	0.4
PNP255	Plastic bush, glue-in, stainless steel lined	12.0	5.0	25.0	20.0	-	3	15/32	3/16	1	25/32	-	0.1
PNP256	Plastic bush, glue-in, stainless steel lined	11.0	14.0	25.0	20.0	-	7	7/16	9/16	1	25/32	-	0.2
PNP39B	Plastic bush, glue-in	13.0	13.0	33.0	25.0	-	4	1/2	1/2	1 5/16	1	-	0.1
PNP258	Plastic bush, screw mount, stainless steel lined	13.0	5.0	36.0	26.0	4.0	10	1/2	3/16	1 13/32	1 1/32	5/32	0.4
PNP259	Plastic bush, glue-in, stainless steel lined	13.0	5.0	28.0	23.0	-	7	1/2	3/16	1 3/32	25/32	-	0.2
PNP260	Plastic bush, glue-in, stainless steel lined	13.0	13.0	28.0	23.0	-	13	1/2	1/2	1 3/32	25/32	-	0.5
PNP257	Plastic bush, screw mount, stainless steel lined	15.0	19.0	36.0	22.0	4.0	16	9/16	3/4	1 13/32	7/8	5/32	0.6
PNP261	Plastic bush, screw mount, stainless steel lined	15.0	5.0	39.0	28.0	4.0	11	9/16	3/16	1 17/32	1 3/32	5/32	0.4
PNP262	Plastic bush, screw mount, stainless steel lined	15.0	14.0	39.0	28.0	4.0	20	9/16	9/16	1 17/32	1 3/32	5/32	0.7

TIE BALLS

- ✔ Tie balls have a stepped bore allowing the rope end knot to be contained within the ball. Ideal for control lines.

HALYARD STOPPERS

- ✔ Tough nylon halyard stoppers are ideal for protecting halyard eye splices and whipping twine where they meet sheaves and exit plates. They have a straight bore with constant diameter.

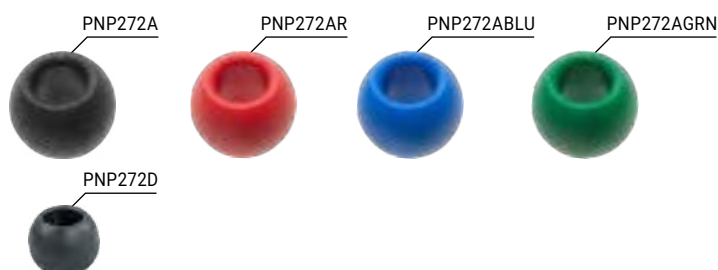

PRODUCT No.	PRODUCT No.	PRODUCT No.	PRODUCT No.	MAX. ROPE mm	OUTSIDE DIAM. mm	WEIGHT g	MAX. ROPE in	OUTSIDE DIAM. in	WEIGHT oz
Tie Balls									
Black	Red	Blue	Green						
RF1318BLK	RF1318R	RF1318BLU	RF1318GRN	4	16	2	5/32	5/8	0.1
RF1317BLK	RF1317R	RF1317BLU	RF1317GRN	5	20	3	3/16	3/4	0.1
RF1316BLK	RF1316R	RF1316BLU	RF1316GRN	5	25	7	3/16	1	0.3
RF1315BLK	RF1315R	RF1315BLU	RF1315GRN	6	32	14	1/4	1 1/4	0.5

PRODUCT No.	PRODUCT No.	PRODUCT No.	PRODUCT No.	INSIDE DIAM. mm	OUTSIDE DIAM. mm	WEIGHT g	INSIDE DIAM. in	OUTSIDE DIAM. in	WEIGHT oz
Halyard Stoppers									
Black	Red	Blue	Green						
PNP272A	PNP272AR	PNP272ABLU	PNP272AGR	15.5	32	11	19/32	1 1/4	0.4
PNP272D	-	-	-	11.0	20	3	7/16	3/4	0.1

PRODUCT No.	DESCRIPTION	WEIGHT g	WEIGHT oz
Handle			
PNP207	Handle. 150mm (6") wide. Requires 2 x 6mm (1/4") fasteners	52	1.8
Hinges & Latches			
PNP89	Cupboard latch. Requires 3 x 4mm (5/32") fasteners	8	0.3
PNP68C	Hinge. 100mm x 53mm (4" x 2 1/8"). Stainless steel pin. Requires 6 x 4mm (3/16") fasteners	37	1.3
RF308	Hinge, pressed stainless steel. 61mm x 32mm (2 3/8" x 1 1/4"). Requires 4 x 5mm (3/16") fasteners	20	0.7



PRODUCT No.	DESCRIPTION	WEIGHT g	WEIGHT oz
Plumbing Fittings			
PNP131	Non-return valve. Suits 12mm (1/2"), 20mm (3/4") & 25mm (1") ID tube	41	1.4
PNP132A	Skin fitting. Suits 16mm (5/8") ID tube. 20mm (3/4") maximum hull thickness	20	0.7
PNP132B	Skin fitting. Suits 20mm (3/4") ID tube. 38mm (1 1/2") maximum hull thickness	40	1.4
PNP132C	Skin fitting. Suits 25mm (1") ID tube. 38mm (1 1/2") maximum hull thickness	55	1.9
PNP132E	Skin fitting. Suits 38mm (1 1/2") ID tube. 38mm (1 1/2") maximum hull thickness	138	4.8
PNP310	Sink waste. Suits 25mm (1") ID tube, white	25	0.9
PNP310G	Sink waste. Suits 25mm (1") ID tube, grey	25	0.9
PNP315	Sink waste, 90 degree. Suits 25mm (1") ID tube	50	1.7



- ✔ Drain plugs are fitted with watertight seals and some models have retaining legs to prevent accidental loss. Plugs are available separately as spares.
- ✔ Clipped housing flange on PNP245, PNP245BLK, PNP246, PNP246BLK allows plug to be fitted low in hull to maximise drainage.
- ✔ PNP96, PNP97 and PNP390 are manufactured with dissimilar materials for the lid and deck ring to avoid binding.
- ✔ Impact resistant, UV stabilised nylon.
- ✔ Inspection ports provide access to areas under decks or behind bulkheads. Watertight integrity is assured by threaded closure and an O-ring seal.
- ✔ PNP390 & PNP393 feature an overlapping threaded lid for a smooth, clean style.

PRODUCT No.	DESCRIPTION	REPLACEMENT O-RING	REPLACEMENT PLUG	CUTOUT DIAM. mm	WEIGHT g	CUTOUT DIAM. in	WEIGHT oz
Drain Plugs							
PNP241	Drain plug & housing, nylon, white	-	PNP241A	19	10	3/4	0.4
PNP242	Drain plug & housing, nylon, white	PNP242B	PNP242A	25	10	1	0.3
PNP243	Drain plug & housing, nylon, white	PNP243B	PNP243A	30	16	1 3/16	0.6
PNP245	Drain plug & housing, nylon, white	PNP245B	PNP245A	40	27	1 7/16	0.9
PNP245BLK	Drain plug & housing, nylon, black	PNP245B	PNP245ABLK	40	27	1 7/16	0.9
PNP246	Drain plug & housing, nylon, white	PNP246B	PNP246A	50	38	2	1.3
PNP246BLK	Drain plug & housing, nylon, black	PNP246B	PNP246ABLK	50	38	2	1.3
RF294	Drain plug & housing, coarse thread, nylon, black	-	RF738	24	10	1 5/16	0.4
RF734	Drain plug & housing, low profile, chromed brass	-	-	24	70	1 5/16	2.5
RF737	Drain plug & housing, chromed brass body, nylon plug	-	RF738	24	45	1 5/16	1.6

PRODUCT No.	DESCRIPTION	REPLACEMENT O-RING	REPLACEMENT LID	OPENING DIAM. mm	OUTSIDE DIAM. mm	CUTOUT DIAM. mm	WEIGHT g	OPENING DIAM. in	OUTSIDE DIAM. in	CUTOUT DIAM. in	WEIGHT oz
Inspection Hatches											
PNP96	Inspection hatch, white	-	-	102	144	112	94	4	5 5/8	4 1/2	3.3
PNP97	Inspection hatch, white	-	-	129	170	139	115	5 1/8	6 11/16	5 1/2	4.1
PNP390	Inspection hatch, white	-	-	150	192	163	166	5 7/8	7 9/16	6 7/16	5.8
PNP393	Inspection hatch, black	-	-	200	258	218	350	8	10 5/32	8 9/16	12.3
PNP393W	Inspection hatch, white	-	-	200	258	218	350	8	10 5/32	8 9/16	12.3
RF530	Inspection hatch, white	RF531	RF530LIDSW	106	148	122	110	4 3/16	5 3/16	4 13/16	3.9

WIND VANE PRO

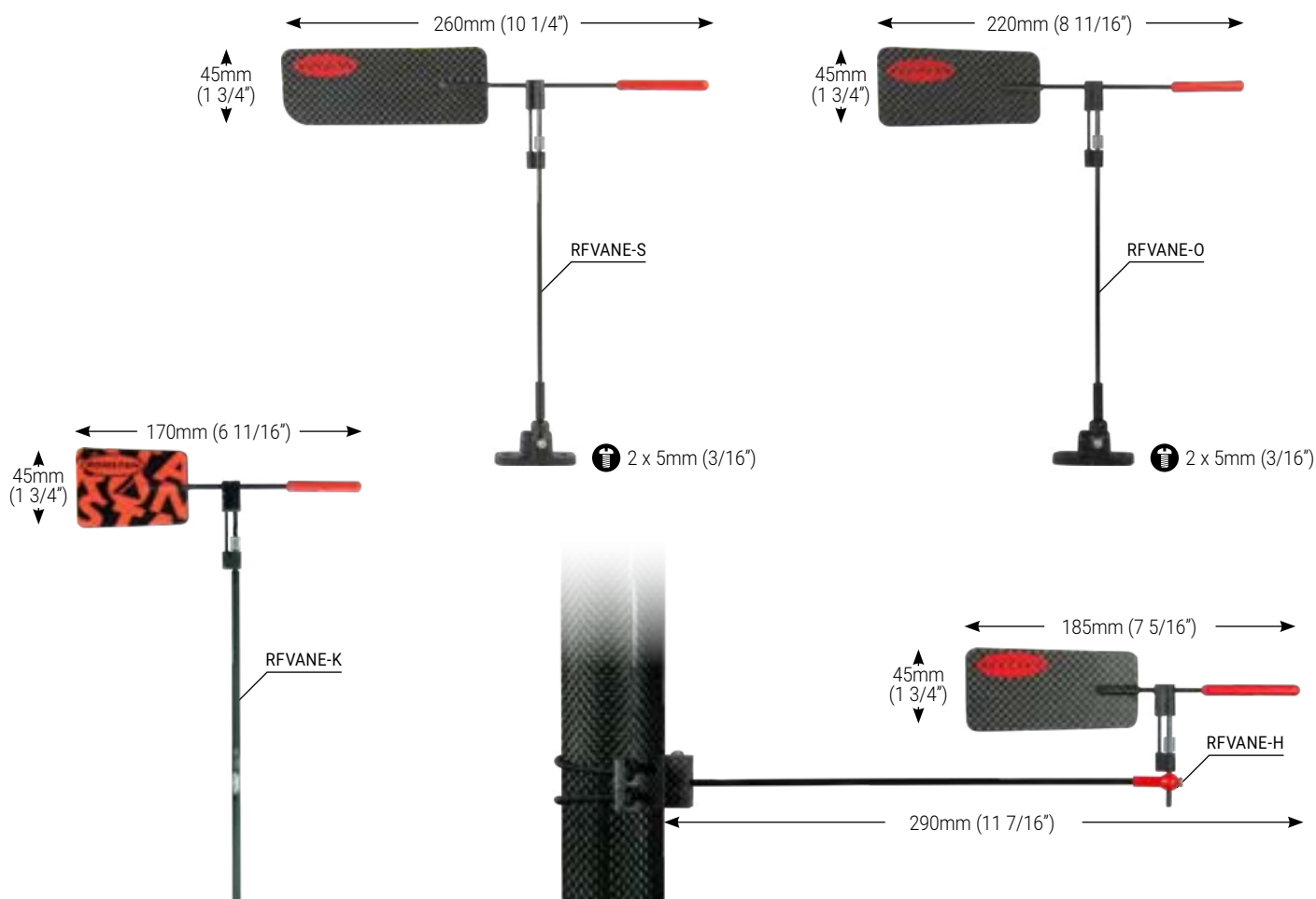

© St. Francis Yacht Club / Amanda Witherell

- ✔ Ultra-lightweight, handmade composite wind vanes.
- ✔ Accurate from 0.8 to 40 knots.
- ✔ Suits small keelboats and dinghies with vertical or parallel mounting options.
- ✔ Perfect for every kind of performance sailing.
- ⚓ Crazy Kids is specifically designed for carbon-free dinghies to 3.5m (12ft), mast top vane mounting plugs supplied by mast manufacturer.
- ⚓ Horizontal is designed for boats to 5m (16ft) with adjustable mast clamp.
- ⚓ Olympic is designed for off-the-beach classes to 6m (20ft).
- ⚓ Sportsboat is designed for boats to 8.5m (28ft).

PRODUCT No.	DESCRIPTION	MAX. BOAT m	SIZE (W x H) mm	WEIGHT g	MAX. BOAT ft	SIZE (W x H) in	WEIGHT oz
Wind Indicators							
RFVANE-K	Fibreglass - Crazy Kids	3.5	170 x 320	22	12	7 x 12 1/2	0.8
RFVANE-H	Carbon - Horizontal	5	360 x 90	37	16	14 x 3 1/2	1.3
RFVANE-O	Carbon - Olympic	6	220 x 270	27	22	8 1/2 x 10 1/2	1.0
RFVANE-S	Carbon - Sportsboat	8.5	260 x 290	27	28	10 x 11	1.0



- ✔ Windex® wind indicators feature apparent wind angle indication, adjustable tacking angle arms, lightweight plastic and alloy construction, and sapphire jewel bearings for extreme sensitivity.
- ✔ Windex® WXLED light illuminates vane & arms for night sailing. Featuring a non-dazzling lens, 12 volts low power consumption LED globe. Encased in a sealed waterproof housing. Fits directly to WX10C, WX15 and WX23 mounts

- ✔ WX10C features Unifix 10 for vertical or horizontal mounting.
- ✔ WX15 and WX23 feature a secure screw-on mount.
- ✔ WX10C, WX15 and WX23 feature vane and arm underside reflectors for night sailing.
- ✔ PNP301 wind vane is balanced for accuracy and moulded in UV stabilised nylon. It has adjustable tacking angle arms and can be removed from the mast bracket for convenience and security.

- ⬆ WX10C Medium Windex® is specifically designed for trailerables and small keelboats.
- ⬆ WX15 Large Windex® is specifically designed for keelboats.
- ⬆ WX23 Extra Large Windex® is specifically designed for large keelboats.

PRODUCT No.	DESCRIPTION	VANE LENGTH mm	WEIGHT g	VANE LENGTH in	WEIGHT oz
Wind Indicators					
PNP301	Arrow style wind vane. Mounting bracket and screws included.	220	18	8 5/8	0.6
WXD6	Dinghy Windex® 6, mast mount	150	33	6	1.2
WX10C	Medium Windex®, Medium Windex, Unifix 10 bracket, vertical or horizontal mount	250	40	10	1.4
WX15	Large Windex®, 8mm (5/16") bolt-on mount, nut and washer included	380	100	15	3.5
WX23	Extra Large Windex®, 8mm (5/16") bolt-on mount, nut and washer included	580	285	23	10.0
WXLED	Windex® LED light	-	15	-	0.5
WX15-BIRD	Windex® BirdSpike suits WX15, Carbon Fibre	-	4	-	0.1

PRODUCT No.	DESCRIPTION	PRODUCT No. TO SUIT WXD6	PRODUCT No. TO SUIT WX10C	PRODUCT No. TO SUIT WX15	PRODUCT No. TO SUIT WX23	PRODUCT No. TO SUIT WXLED
Spare Parts						
Arms	Arms	-	WX10-A	WX15-A	WX23-A	-
Rods	Supporting rod	WXD6-R	WX10-R	WX15-R	WX23-R	-
Sockets	Mast socket	-	WX10C-S	WX15-S	WX23-S	-
Vanes	Vane unit	WXD6-V	WX10-V	WX15-V	WX23-V	-
Globes	Spare globe	-	-	-	-	WXL-G
Mast Fitting	Mast fitting	WXD6-M	-	-	-	-
Mast Locking Device	Mast locking device	WXD6-MLD	-	-	-	-

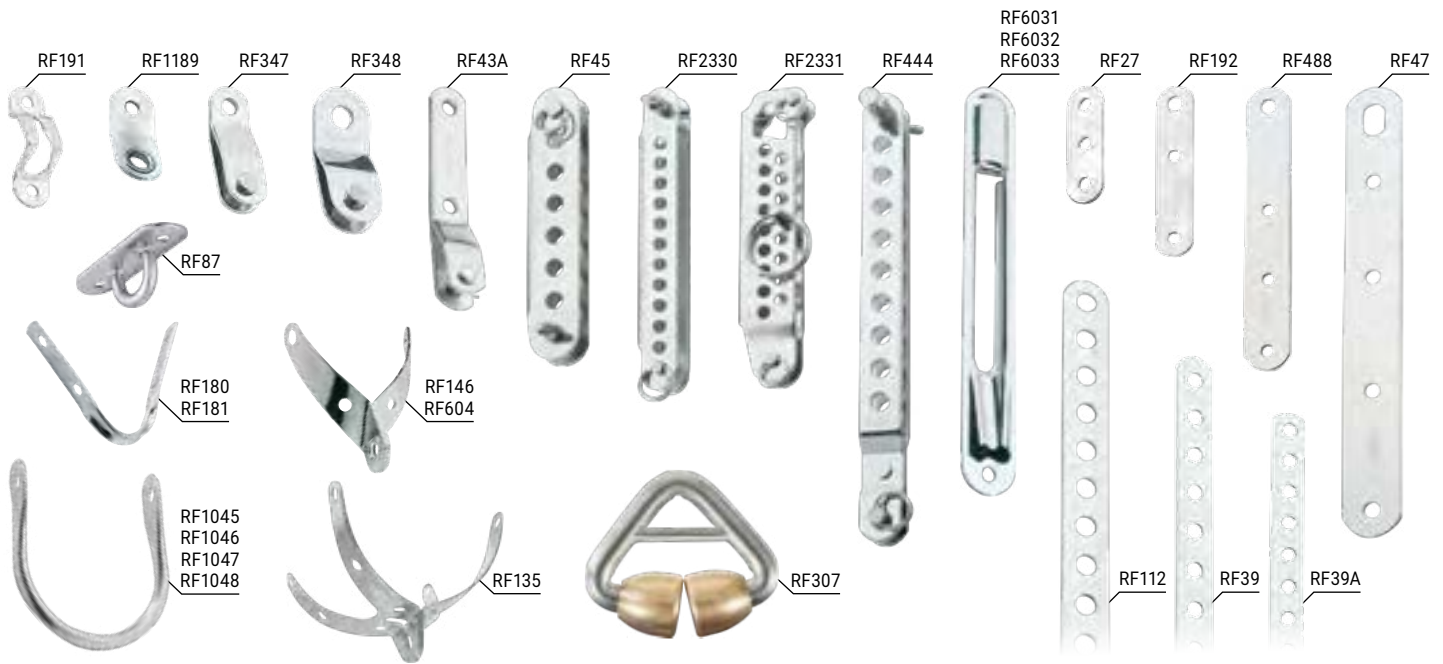

PRODUCT No.	DESCRIPTION	WEIGHT g	WEIGHT oz
-------------	-------------	----------	-----------

Mast Tangs & Hounds

RF43A	Tang. 5mm (3/16") diameter clevis pin. 76mm (3") long. 2 x 5mm (3/16") diameter fixing holes	15	0.5
RF146	Mast hound to suit mast diameters between 76mm-115mm (3"-4 1/2"). 10 x 4.2mm (5/32") fixing holes	110	3.9
RF347	Tang. 6.4mm (1/4") diameter clevis pin. 51mm (2") long. 1 x 6.4mm (1/4") diameter fixing hole	20	0.7
RF348	Tang. 8mm (5/16") diameter clevis pin. 64mm (2 1/2") long. 1 x 9.5mm (3/8") diameter fixing hole	40	1.4
RF604	Mast hound to suit mast diameters 51mm-64mm (2"-2 1/2"). 2 x 6.8mm (9/32") & 2 x 5.0mm (3/16") fixing holes	30	1.1
RF1189	Tang. 6.4mm (1/4") ferrule eye. 38mm (1 1/2") long. 1 x 5mm (3/16") diameter fixing hole	10	0.4

Boom Hangers

RF87	Boom hanger. 10mm (3/8") internal clearance. 5mm (3/16") diameter loop. 2 x 5mm (3/16") diameter fixing holes	15	0.5
RF135	Four point hanger. Slotted attachment hole allows shackle body to be passed through. 8 x 5mm (3/16") diameter fixing holes	35	1.2
RF180	Strip hanger. 64mm (2 1/2") long. 4 x 5mm (3/16") diameter fixing holes	20	0.7
RF181	Strip hanger. 55mm (2 1/4") long. 4 x 5mm (3/16") diameter fixing holes	20	0.7
RF1045	Boom hanger. 80mm (3 1/8") long. 65mm (2 1/2") wide. Bar diameter 6.4mm (1/4"). 2 x 6.6mm (1/4") diameter fixing holes	45	1.6
RF1046	Boom hanger. 100mm (4") long. 80mm (3 1/8") wide. Bar diameter 6.4mm (1/4"). 2 x 6.6mm (1/4") diameter fixing holes	54	1.9
RF1047	Boom hanger. 125mm (5") long. 80mm (3 1/8") wide. Bar diameter 7.9mm (5/16"). 2 x 8.1mm (5/16") diameter fixing holes	107	3.8
RF1048	Boom hanger. 150mm (6") long. 115mm (4 1/2") wide. Bar diameter 9.5mm (3/8"). 2 x 10mm (3/8") diameter fixing holes	190	6.7

Exit Plates & Halyard Lock

RF191	Halyard lock for locking halyards off on a copper ferrule	5	0.2
RF6031	Exit plate, stainless steel, slot width 10mm (3/8"), 159 x 21mm (6 1/4" x 13/16") overall	45	1.6
RF6032	Exit plate, stainless steel, slot width 12mm (1/2"), 203 x 26mm (8" x 1") overall	70	2.5
RF6033	Exit plate, stainless steel, slot width 17mm (11/16"), 210 x 28mm (8 1/4" x 1 1/8") overall	73	2.5

Sail Feeder

RF307	Headsail Pre-Feeder, suits up to 7mm luff tapes	67	2.4
-------	---	----	-----

PRODUCT No.	LENGTH OVERALL mm	RANGE OF ADJUSTMENT mm	PIN DIAM. mm	INCREMENTS mm	WEIGHT g	LENGTH OVERALL in	RANGE OF ADJUSTMENT in	PIN DIAM. in	INCREMENTS in	WEIGHT oz	NO. OF ADJUSTMENT SETTINGS
-------------	-------------------	------------------------	--------------	---------------	----------	-------------------	------------------------	--------------	---------------	-----------	----------------------------

Stay Adjusters

RF45	108	75	6.4	12.5	60	4 1/4	3	1/4	1/2	2.1	7
RF444	174	115	6.4	12.5	90	6 7/8	4 1/2	1/4	1/2	3.2	10
RF2330	117	87	4.8	8.0	40	4 5/8	3 7/16	3/16	5/16	1.4	12
RF2331	115	64	4.8	4.0	65	4 1/2	2 1/2	3/16	5/32	2.3	17

PRODUCT No.	DESCRIPTION	HOLE SPACING mm	LENGTH OVERALL mm	WIDTH x THICKNESS mm	HOLE DIAMS. mm	WEIGHT g	HOLE SPACING in	LENGTH OVERALL in	WIDTH x THICKNESS in	HOLE DIAMS. in	WEIGHT oz
-------------	-------------	-----------------	-------------------	----------------------	----------------	----------	-----------------	-------------------	----------------------	----------------	-----------

Chain Plates & Perforated Strip

RF27	Chain plate	-	48.6	16.0 x 1.5	5.0	5	-	2	5/8 x 1/16	3/16	0.2
RF39	Perforated strip	15.9	925	15.9 x 1.5	6.6	144	5/8	36 13/32	5/8 x 1/16	1/4	5.1
RF39A	Perforated strip	12.7	915	12.7 x 1.5	5.0	127	1/2	36 1/16	1/2 x 1/16	3/16	4.5
RF47	Chain plate	-	203	25.0 x 1.5	1 x 9.5 + 3 x 6.4	60	-	8	1 x 1/16	1 x 3/8 + 3 x 1/4	2.1
RF112	Perforated strip	15.9	896	19.0 x 2.0	8.1	222	5/8	35 1/4	3/4 x 5/64	5/16	7.8
RF192	Chain plate	-	76	16.0 x 1.5	1 x 6.4 + 2 x 5.0	10	-	3	5/8 x 1/16	1 x 1/4 + 3 x 3/16	0.4
RF488	Chain plate	-	127	19.0 x 3.0	1 x 6.4 + 2 x 5.0	53	-	5	3/4 x 1/8	1 x 1/4 + 3 x 3/16	1.9



© Darren Bundock

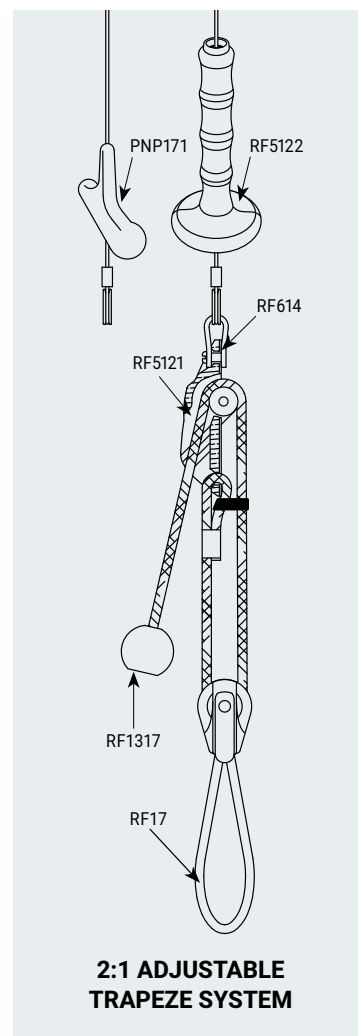

PRODUCT No.	DESCRIPTION	WEIGHT g	WEIGHT oz
Trapeze Hardware			
PNP171BLU	Trapeze handle, 120mm (4 3/4") long, nylon, blue	25	0.9
PNP171R	Trapeze handle, 120mm (4 3/4") long, nylon, red	25	0.9
RF9	Fairlead, nylon, ID 7mm (1/4")	5	0.2
RF17	Trapeze ring, oversize 6mm (7/32") diameter loop, incorporating Series 20 ball bearing sheave	84	3.0
RF27	Toe strap plate, stainless steel, 50mm x 16mm (2" x 5/8"), 5mm (3/16") diameter holes	5	0.2
RF48B	Trapeze ring, twin loop, stainless steel, 166mm (6 1/2") long	48	1.7
RF341	Single V-jam block, becket, removable clevis pin top	30	1.1
RF5121	Trapeze cleat, aluminium, suits 4-8mm (5/32"-5/16") diameter rope	46	1.6
RF5122R-2	Trapeze handles, vertical grip, red, hole diameter 7mm (9/32") (pair)	85	3.0

PRODUCT No.	PRODUCT No.	PRODUCT No.	PRODUCT No.	MAX. ROPE mm	OUTSIDE DIAM. mm	WEIGHT g	MAX. ROPE in	OUTSIDE DIAM. in	WEIGHT oz
Red Tie Ball	Blue Tie Ball	Black Tie Ball	Green Tie Ball						
RF1317R	RF1317BLU	RF1317BLK	RF1317GRN	5	20	3	3/16	3/4	0.1



© Michael Chittenden



PRODUCT No.	DESCRIPTION	DOUGHNUT DIAM. mm	ROPE DIAM. mm	WEIGHT g	DOUGHNUT DIAM. in	ROPE DIAM. in	WEIGHT oz
Spinnaker Brace 'Doughnut'							
PNP197R	Red	40	10	7	1 9/16	3/8	0.2
PNP197GRN	Green	40	10	7	1 9/16	3/8	0.2
PNP198R	Red	60	12	22	2 3/8	7/16	0.8
PNP198GRN	Green	60	12	22	2 3/8	7/16	0.8
PNP199R	Red	70	18	34	2 3/4	5/8	1.2

PRODUCT No.	DESCRIPTION	RING I.D. mm	MATERIAL DIAM. mm	MAST DIAM. mm	WEIGHT g	RING I.D. in	MATERIAL DIAM. in	MAST DIAM. in	WEIGHT oz
Spinnaker Pole Rings									
RF30	Curved base	30	6.4	60	45	1 3/16	1/4	2 3/8	1.6
RF41	Curved base	44	11.0	80	260	1 3/4	7/16	3 1/8	9.2
RF602	Curved base	35	8.0	60	80	1 3/8	5/16	2 3/8	2.8

Spinnaker Hardware

RF91	Spinnaker brace hook, accepts up to 6mm (1/4") diameter line, 1/4" diameter bolt-through attachment (includes 2 x self-tapping screws), neoprene pad and line retainer				40				1.4
RF92	Spinnaker brace hook, screw-on attachment, (includes two 8g self-tapping screws), neoprene pad and line retainer				20				0.7
PNP94	Spinnaker pole deck bracket, suits poles to 70mm (2 3/4") diameter				75				2.7

Mast Chock

PNP200	Mast chock set, 8 pieces; with total thickness 70mm (2 3/4"); 1 x 20mm (25/32") piece, 5 x 10mm (13/32") pieces, suits mast with 50-60mm (2" - 2 3/8") diameter				134				4.7
--------	---	--	--	--	-----	--	--	--	-----



- ✔ PNP164, PNP165 and PNP166 small boat pole ends are manufactured from tough, abrasion resistant nylon for minimum weight and corrosion resistance.
- ✔ RF600, RF601 and RF677 grade 316 stainless steel small boat pole ends suit external fitting on solid or tubular sections.
- ✔ Acetal sleeves adapt end fittings to suit different pole diameters. Custom sizes available on request.
- ✔ Keelboat spinnaker pole ends are opened with an internal trip line, and close automatically when integrated trigger is depressed. Holes provided suit shackle or rope loop for topping lift and foreguy attachment.
- ✔ Isolating bush ensures smooth piston travel and protects against corrosion, integral ball bearing swivel for trip line attachment.
- ✔ RF1666 and RF1667 inboard ends suit RC13046 spinnaker pole car.
- ✔ RF1664 and RF1665 outboard ends: anodised aluminium body, grade 316 stainless steel hardware
- ✔ RF1666 and RF1667 inboard ends: acetal body with grade 316 stainless hardware.

PRODUCT No.	DESCRIPTION	A mm	WEIGHT g	A in	WEIGHT oz
Spinnaker Pole Ends - Small Boat					
PNP164	Nylon body, stainless steel push-on plunger pin, accepts up to 8mm (5/16") diameter ring or line	21	33	13/16	1.2
PNP165	Nylon body, stainless steel push-on plunger pin, accepts up to 12mm (1/2") diameter ring or line	28	46	1 1/8	1.6
PNP166	Nylon body, stainless steel push-on plunger pin, accepts up to 12mm (1/2") diameter ring or line	46	125	1 13/16	4.4
RF600	Stainless steel body, stainless steel snap-on plunger pin and straps, accepts up to 9.5mm (3/8") diameter ring or line	26	175	1	6.2
RF601	Stainless steel body, stainless steel snap-on plunger pin and straps, accepts up to 9.5mm (3/8") diameter ring or line	36	180	1 7/16	6.3
RF677	Stainless steel body, stainless steel snap-on plunger pin and straps, accepts up to 9.5mm (3/8") diameter ring or line	32	175	1 1/4	6.2
Spinnaker Pole Ends - Keelboat					
RF1664	Outboard pole end, aluminium with internal stainless steel plunger pin, trigger operated	45.8	290	1 13/16	10.2
RF1664S48	Acetal sleeve for RF1664, suits tube ID 48mm	47.5	10	1 7/8	0.4
RF1664S56	Acetal sleeve for RF1664, suits tube ID 56mm	55.8	60	2 3/16	2.1
RF1665	Outboard pole end, aluminium with internal stainless steel plunger pin, trigger operated	64.5	732	2 9/16	25.8
RF1665S74	Acetal sleeve for RF1655, suits tube ID 74mm	73.8	90	2 15/16	3.2
RF1665S96	Acetal sleeve for RF1655, suits tube ID 96mm	95.9	328	3 3/4	11.7
RF1666	Inboard pole end, acetal and stainless steel	73.8	933	2 15/16	32.9
RF1667	Inboard pole end, acetal and stainless steel	95.9	1174	3 3/4	41.4

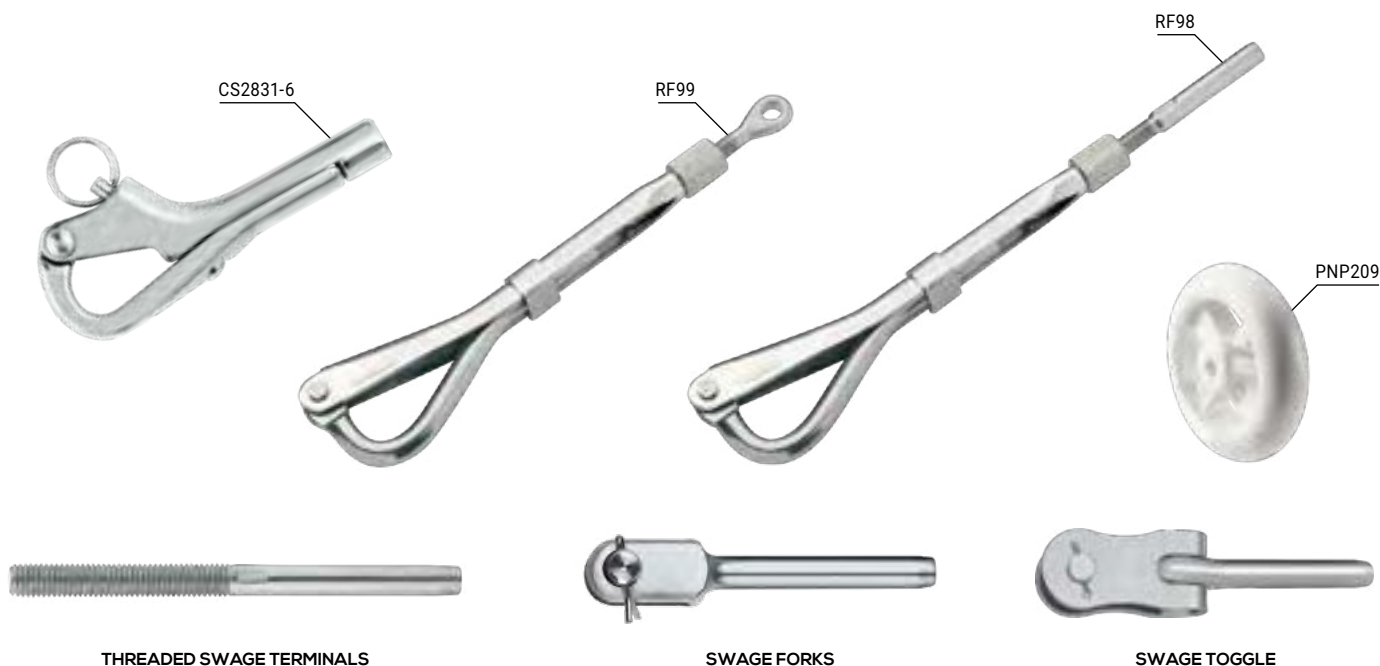

✓ RF98, RF99: Pelican hooks are manufactured from stainless steel and have threaded tensioning adjustment, a long lever arm to facilitate closing under tension and a sliding sleeve retainer for quick opening and closing.

✓ PNP209 roller is used on life lines, above spreaders and on back stays to assist tacking and prevent sail chafe. It has a snap-together design that allows fitting to existing rigging.

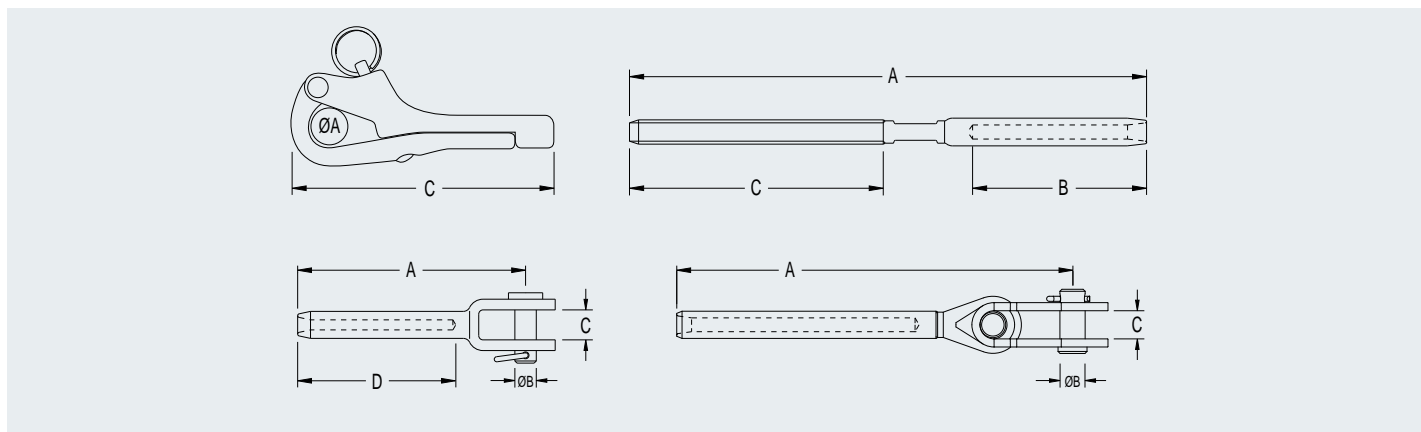

PRODUCT No.	DESCRIPTION	WIRE DIAM.	THREAD	A mm	B mm	C mm	D mm	WEIGHT g	A in	B in	C in	D in	WEIGHT oz
Pelican Hooks													
RF98	Pelican hook, swage end, BL 400kg (880lb)	4mm (5/32")	1/4"	15	-	-	-	112	19/32	-	-	-	4.0
RF99	Pelican hook, 6.4mm (1/4") diameter eye end, BL 400kg (880lb)	-	1/4"	15	-	-	-	115	19/32	-	-	-	4.1
CS2831-6	Pelican hook	-	M6	10	-	73	-	70	3/8	-	2 7/8	-	2.4
Swage Fork, Swage Toggle & Threaded Swage Terminal													
RF1507M0404	Swage Toggle	4mm (5/32")	-	87.1	6.2	7.8	-	44	3 7/16	1/4	5/16	-	1.6
RF1509M0405	Swage Fork	4mm (5/32")	-	75.5	7.8	4.9	45.5	34	2 31/32	5/16	3/16	1 25/32	1.2
CS7803-04M5	Swage Fork	3mm (1/8")	-	74.0	5.0	7.0	38.0	22	2 7/8	3/16	9/32	1 1/2	0.7
CS7803-05	Swage Fork	4mm (5/32")	-	77.0	8.0	11	45.0	44	3	5/16	7/16	1 3/4	1.6
CS7801-M03M6	Threaded swage terminal	3mm (1/8")	M6	98.0	40	48	-	23	3 7/8	1 5/8	1 7/8	-	0.8
CS7801-M04M6	Threaded swage terminal	4mm (5/32")	M6	111	45	48	-	26	4 3/8	1 3/4	1 7/8	-	0.9
Anti-Chafe / Life Line Roller													
PNP209	Spreader / backstay / life line roller, nylon	5mm (3/16")	-	-	-	-	-	38	-	-	-	-	1.3

Note - Commodity stainless product dimensions are indicative and subject to change

 RF3910
RF3911
RF3912

RF3941



RF3951

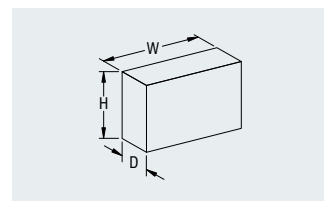

☑ Fibreglass entry edge rods for easy opening (rope bags).

☑ Mounting: hook-and-loop fixing, screw-on option for rope bags (screws not provided).

☑ Mesh panels for drainage & ventilation.

PRODUCT No.	DESCRIPTION	W mm	H mm	D mm	WEIGHT g	W in	H in	D in	WEIGHT oz
Rope Bags									
RF3910	Rope bag, grey PVC with mesh, wide	300	200	180	450	11 13/16	7 7/8	7 3/32	15.9
RF3911	Rope bag, grey PVC with mesh, wide	400	250	200	650	15 3/4	9 27/32	7 7/8	22.9
RF3912	Rope bag, grey PVC with mesh, wide	500	300	220	830	19 11/16	11 13/16	8 21/32	29.3
Winch Handle Pocket									
RF3941	Winch handle pocket, grey PVC with mesh	140	280	90	230	5 17/32	11 1/32	3 7/32	8.1
Drink Holder									
RF3951	Drink holder, grey PVC with mesh	130	130	90	130	5 1/8	5 1/8	3 17/32	4.6



☑ Steering cable pulleys have durable acetal sheaves with a deep groove to cradle 5mm (3/16") diameter wire.

⚙ Pulley housings are stainless steel (except RF2417 which is chrome plated bronze.)

⚙ RF111 is made from durable, UV stabilised high density polyethylene with two-way rope grooves and an eye at each end for maximum versatility.

PRODUCT No.	DESCRIPTION	M.W.L. kg	B.L. kg	WEIGHT g	M.W.L. lb	B.L. lb	WEIGHT oz
Steering Cable Pulleys							
RF144	Pulley, single 65mm (2 1/2") diameter pulley. 4.8mm (3/16") diameter swivel shackle top	350	750	75	770	1650	2.7
RF154	Pulley, single 65mm (2 1/2") diameter pulley. 13mm (1/2") ID ring brass swivel ring top	300	600	80	660	1320	2.8
RF155	Pulley, double 65mm (2 1/2") diameter pulley. 13mm (1/2") ID ring brass swivel ring top	150	600	135	330	1320	4.8
RF2416	Pulley, single 32mm (1 1/4") diameter pulley. Upright mount	300	800	40	660	1760	1.4
RF2419	Pulley, single 55mm (2 1/8") diameter pulley. Flat mount	500	1500	80	1100	3300	2.8
RF2420	Pulley, single 55mm (2 1/8") diameter pulley. Upright mount	900	1800	70	1980	3960	2.5
RF2421	Pulley, single 55mm (2 1/8") diameter pulley with becket. Upright mount	350	1300	75	770	2860	2.7
RF2422	Pulley, single 65mm (2 1/2") diameter pulley. Loop top	700	1800	60	1540	3960	2.1
Steering Accessories							
RF149	Steering cable tension spring. stainless steel	-	-	75	-	-	2.7
RF2415	Cable clamp. Suits 5mm (3/16") diameter wire	-	-	30	-	-	1.1
Buoys							
RF111	Marker buoy, UV stabilised high density polyethylene, supports 9kg, red. Overall length: 483mm (19"). Maximum diameter: 184mm (7 1/4")	-	-	680	-	-	24.0

GELCOAT POLISH RF2632

- ✔ Ideal for restoring chalky and deteriorated surfaces.
- ✔ Ideal for preparing fibreglass surfaces and detailing fibreglass moulds.
- ✔ Waxless, silicone-free formula - can be overpainted.
- ✔ Designed for power buffing.
- ✔ Liquid formulation.

SUPER FINE PASTE POLISH RF3001

- ✔ Ideal for enhancing and protecting surfaces in good condition.
- ✔ Suitable for use on fibreglass and painted surfaces.
- ✔ Ideal for cleaning and protecting stainless steel and chrome plated fittings.
- ✔ Contains waxes to promote high lustre and depth of colour.
- ✔ Contains silicone to ensure long lasting shine.
- ✔ Contains mild abrasive.
- ✔ No-run paste formulation.

EXTRA CUT PASTE POLISH RF3002

- ✔ Ideal for restoring weathered or rough surfaces.
- ✔ Suitable for use on fibreglass or enamel surfaces.
- ✔ Contains waxes to promote high lustre and depth of colour.
- ✔ Contains silicone to ensure long lasting shine.
- ✔ Contains effective abrasives to remove marks, scuffing and surface oxidation.
- ✔ No-run paste formulation.

GELCOAT RESTORER RF3005, RF3005X5.0

- ✔ Ideal for restoring fibreglass to its original colour.
- ✔ Removes difficult stains - rust, brown waterline discolouration etc.
- ✔ Fast acting - 5 minute reaction time.
- ✔ Easy sponge-on, hose-off application.

SAILFAST™ SILICONE LUBRICANT SPRAY RF3004

- ✔ Silicone based for ultimate anti-friction performance.
- ✔ Forms a protective anti-corrosive film against the elements.
- ✔ Displaces moisture.
- ✔ Penetrates and loosens seized mechanical parts.
- ✔ Ideal for use on blocks, travellers, cam cleats, winches, steering gear, spinnaker pole ends, rope clutches, snap shackles, head foils, track slides, furlers, swivels, halyard sheaves, and rigging screws.

Material Data Sheets are available under the **SUPPORT** tab at www.ronstan.com.

PRODUCT No.	DESCRIPTION	VOLUME	WEIGHT g	WEIGHT oz
Boat Care Products				
RF2632*	Gelcoat polish	1 litre	1270	44.8
RF3001*	Super fine paste polish	-	500	17.7
RF3002*	Extra cut paste polish	-	500	17.7
RF3004*	Sailfast™ silicone lubricant spray	125 ml	145	5.1
RF3005*	Gelcoat restorer	500 ml	590	20.8
RF3005X5.0*	Gelcoat restorer	5 litre	5700	201



SAILING GEAR

PERFORMANCE. COMFORT. CONFIDENCE.

Ronstan's sailing gear is designed for sailors by sailors. Each item in the range has been developed in conjunction with our team sailors and has undergone rigorous testing at the most extreme level so you know you'll be covered regardless of the sort of sailing you're into – recreational through to international competition.

The latest material and production technologies are integrated within the designs and an intelligent layering system delivers the flexibility to kit out for all conditions.

Laminates for warmth

We use a combination of high performance materials with unique properties, formed into specifically functional laminates. These laminates are distributed strategically within the panel layout for optimum water repellency, drying speed, thermal comfort and wind protection.

Ultimate flexibility

Carefully selected high-stretch fabrics in varying thicknesses maximise comfort and flexibility. They feel soft but have the ability to retain their shape and fit.

Layering options

Integral to the Ronstan range is a choice of layering options to suit any weather conditions. Whether it's a sun protection rash top, a hydrophobic fleece-lined thermal or a neoprene top, you can mix and match to form the best combination for the conditions.

Lightweight

All sailors know that thinner usually means lighter. We put the focus on efficiency. The high performance CL250 Pants use super light neoprene foam which is 20% lighter than conventional neoprene. The result is a lighter-weight wetsuit just 2mm (5/64") thick, with no compromise on warmth. While the reduced weight and flexibility are key features, the wetsuit panel design also provides abrasion resistance and extra padding where needed.

Junior range

The CL210J Thermal top, CL800J, CL810J Smock Top and CL260J Shorts make up our Junior range, available in sizes 8 to 12. All the great features of the adult range, but specifically sized and shaped to be the right fit for our youngest sailors.



CL270 SKIFFSUIT™
INTELLIGENT FEATURES

Developed in conjunction with our team sailors and leading experts in the latest materials and production techniques, Ronstan's wetsuits integrate an intelligent layering system that delivers performance, warmth and flexibility for any conditions, regardless of the kind of sailing you do.

- 1 Super-Stretch Entry**
Lightweight 4-way stretch material offers convenient entry and unrivalled flexibility.
- 2 Mesh-Skin Embossed Chest Panel**
Eliminates wind chill affect and the fast-drying fleece-liner keeps you drier and warmer.
- 3 Abrasion Resistant Seat Panel**
Reinforced seat for durability and additional rear thigh padding for comfort while hiking.
- 4 Reinforced Knees and Insert**
Maximising your protection and durability, a Skiffsuit™ hallmark.
- ✓ 2mm (5/64") thick, with 3mm (1/8") thick rear thigh padding**
Just-right thickness for warmth and protection.
- ✓ Available Sizes**
XXS – XXL

SIZE	HEIGHT cm	CHEST cm	WAIST cm	HEIGHT ft in	CHEST in	WAIST in
Skiffsuit™						
XXS	163 - 168	86 - 91	63 - 69	5' 4" - 5' 6"	33 - 35	25 - 27
XS	167 - 172	90 - 95	67 - 73	5' 6" - 5' 8"	35 - 37	26 - 29
S	171 - 176	94 - 99	71 - 77	5' 7" - 5' 9"	37 - 39	28 - 30
M	175 - 180	98 - 103	75 - 81	5' 9" - 5' 11"	39 - 41	30 - 32
L	179 - 184	102 - 107	79 - 86	5' 10" - 6' 0"	40 - 42	31 - 34
XL	183 - 188	106 - 111	83 - 90	6' 0" - 6' 2"	42 - 44	33 - 35
XXL	187 - 192	110 - 115	87 - 94	6' 2" - 6' 4"	43 - 45	34 - 37

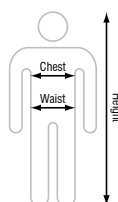

*Sizes based on person not garment



**CL250
NEOPRENE PANTS**

- ✔ **2mm (5/64") thick, with 3mm (1/8") thick rear thigh padding**
Just-right thickness for warmth and protection.
- ✔ **High & Wide Waist**
Gives lower-back protection and over-lap with top. Wide waist belt with hook-and-loop adjustment for added comfort and secure fit.
- ✔ **Super-Light Neoprene**
20% lighter with greater comfort and no compromise on warmth.
- ✔ **Hydrophobic Soft-Brushed Lining**
Keeps skin drier and warmer.
- ✔ **Padded Knee Inserts**
Seamless behind-the-knees design for max comfort.
- ✔ **Available Sizes**
XS - XXL

**CL260
NEOPRENE SHORTS**

- ✔ **2mm (5/64") thick, with 3mm (1/8") thick rear thigh padding**
Just-right thickness for warmth and protection.
- ✔ **Ultra-Comfortable**
The elastic drawstring waist, Glideskin leg openings and soft leg rolls above knees provide excellent flexibility and comfort.
- ✔ **Quick-Dry Capable**
Lined with quick-dry plush thermal lining.
- ✔ **Super-Stretchy & Abrasion Resistant**
Seat and hiking panels at the backs of the thighs and flexible side panels provide continual comfort when hiking, while the non-slip leg openings minimise moisture and ride-up.
- ✔ **Available Sizes**
Adult XS - XXL; Junior: J08, J10, J12

SIZE	HEIGHT cm	CHEST cm	WAIST cm	HEIGHT ft in	CHEST in	WAIST in
Shorts						
J08	127 - 134	67 - 71	59 - 64	4' 2" - 4' 5"	26 - 28	23 - 25
J10	135 - 144	71 - 75	62 - 67	4' 5" - 4' 9"	28 - 30	24 - 26
J12	146 - 155	75 - 79	65 - 70	4' 9" - 5' 1"	30 - 31	25 - 28
Pants & Shorts						
XS	167 - 172	90 - 95	67 - 73	5' 6" - 5' 8"	35 - 37	26 - 29
S	171 - 176	94 - 99	71 - 77	5' 7" - 5' 9"	37 - 39	28 - 30
M	175 - 180	98 - 103	75 - 81	5' 9" - 5' 11"	39 - 41	30 - 32
L	179 - 184	102 - 107	79 - 86	5' 10" - 6' 0"	40 - 42	31 - 34
XL	183 - 188	106 - 111	83 - 90	6' 0" - 6' 2"	42 - 44	33 - 35
XXL	187 - 192	110 - 115	87 - 94	6' 2" - 6' 4"	43 - 45	34 - 37

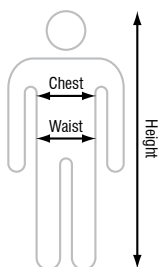

*Sizes based on person not garment

CL240
NEOPRENE SKIN TOP

- ✔ **1.5mm (1/16") Thick**
Lightweight and super-tough!
- ✔ **High-Stretch Fabric**
Includes seamless underarm panels for freedom of movement.
- ✔ **Plush Thermal Lining**
Soft-feel fleece that is quick drying.
- ✔ **Non-Chafe Neoprene Collar**
Glideskin collar & cuffs for greater comfort.
- ✔ **Available Sizes**
XS - XXL

CL210
THERMAL TOP

- ✔ **Maximum Comfort**
Low collar, seamless underarm panels and an athletic fit make it perfect for layering.
- ✔ **Hydrophobic Outer Treatment**
Helps shield you from unwanted splashes and sprays.
- ✔ **UV-Smart**
UPF 50+ UV-protection against the sun.
- ✔ **Available Sizes**
Adult XS - XXL; Junior: J08, J10, J12

CL220
LONG SLEEVE RASHIE

- ✔ **Maximum Comfort**
Seamless underarm panel and external stitching for a great fit.
- ✔ **UV-Smart**
UPF 50+ UV-protection against the sun.
- ✔ **Ultra-Versatile**
Perfect for any sunny-day action - sailing, surfing or paddling.
- ✔ **Available Sizes**
XS - XXL

SIZE	HEIGHT cm	CHEST cm	WAIST cm	HEIGHT ft in	CHEST in	WAIST in
Tops						
J08	127 - 134	67 - 71	59 - 64	4' 2" - 4' 5"	26 - 28	23 - 25
J10	135 - 144	71 - 75	62 - 67	4' 5" - 4' 9"	28 - 30	24 - 26
J12	146 - 155	75 - 79	65 - 70	4' 9" - 5' 1"	30 - 31	25 - 28
Tops						
XS	167 - 172	90 - 95	67 - 73	5' 6" - 5' 8"	35 - 37	26 - 29
S	171 - 176	94 - 99	71 - 77	5' 7" - 5' 9"	37 - 39	28 - 30
M	175 - 180	98 - 103	75 - 81	5' 9" - 5' 11"	39 - 41	30 - 32
L	179 - 184	102 - 107	79 - 86	5' 10" - 6' 0"	40 - 42	31 - 34
XL	183 - 188	106 - 111	83 - 90	6' 0" - 6' 2"	42 - 44	33 - 35
XXL	187 - 192	110 - 115	87 - 94	6' 2" - 6' 4"	43 - 45	34 - 37

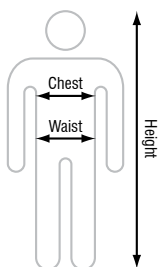

*Sizes based on person not garment



CL800 RED & CL810 BLACK SMOCK TOP PERFECT SOLUTION

The Regatta Smock Top's premium technical fabrics, practical design and smart-fit features meet the demands of today's casual and competitive sailors alike. Layered in combination with the Ronstan Thermal Top or Ronstan Rashie and you're set for whatever the day throws at you.

- 1 Extreme Waterproof Capability**
Featuring Ronstan's improved and highly waterproof R-Tech10 fabric - exceeding the demands of today's competitive sailors.
- 2 High-Ingress Protection**
Front neck opening with internal gusset and neck closure tab keeps water out and wearer dry.
- 3 Breathable Comfort**
Triple layered fabric with taped inner shell provides wearer with a comfortable, breathable fit.
- 4 Snug-flex Fit**
Neoprene waist band, stretch cuffs and neck seals with hook-and-loop adjustments, ensures a warm, snug fit and non-slip finish reduces ride-up.
- ✓ PFD-Ready**
Designed to be worn under PFD, the athletic cut makes for a closer fit, while still providing freedom of movement and zipped pockets are accessible, with or without a PFD on.
- ✓ Easy Access**
Side access breast pocket with water resistant zip provides easy access; even when wearing a PFD.
- ✓ Available Sizes**
Adult XS - XXL; Junior: J10, J12

SIZE	CHEST cm	BACK LENGTH cm	SLEEVE LENGTH cm	CHEST in	BACK LENGTH in	SLEEVE LENGTH in
Smock Top						
J08	77	54	62	30	21	24
J10	86	58	66	34	23	26
J12	94	63	71	37	25	28
Smock Top						
XXS	100	65	76	39	26	30
XS	106	68	79	42	27	31
S	111	70	82	44	28	32
M	119	72	84	47	28	33
L	124	74	86	49	29	34
XL	129	76	88	51	30	35
XXL	133	78	90	52	30	35
XXXL	135	80	92	53	31	36

*Sizes based on garment not person

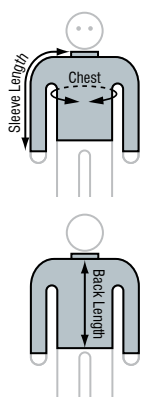



PRODUCT		CL210 Thermal Top	CL240 Neoprene Skin Top	CL220 Rash Top	CL800 & CL810 Smock Top
Features		Warm when dry	Warm when wet	Sun protection	Waterproof & windproof barrier
Conditions	Layers				
Cold -Wet - Windy	3	•	•		•
Cold - Dry - Light / No Wind	2	•			•
	2	•	•		
Warm - Wet - Windy	2			•	•
	1		•		
Hot - Wet - Windy	2			•	•
Very Hot	1			•	





CL700 CUT FINGERS
CL710 THREE FULL FINGERS
RACE GLOVES

Durable, synthetic leather gloves that provide max performance with minimum stretch and shrinkage for all your demanding water sport activities – sailing, kayaking, kiteboarding, SUP-ing.

- ✔ **Double-Tough**
Double Aramid-stitched in high-wear areas and double-thick palms and fingers for protection and grip.
- ✔ **Great Flex-Fit**
Hook-and-loop closures and mesh panels add flexibility and comfort.
- ✔ **Versatile**
Low-cut wrist bands for freedom of movement and excellent ClearStart™ watch visibility and operation.
- ✔ **Available Sizes**
XXXXS – XXL

CL730 CUT FINGERS
CL740 THREE FULL FINGERS
STICKY RACE GLOVES

Sticky Race Gloves add grip and reduce fatigue by minimising the physical effort to hold rope – the perfect partner for endurance sailing.

- ✔ **Double-Tough**
Double Aramid-stitched in high-wear areas and double-thick palms and fingers for protection and grip.
- ✔ **Great Flex-Fit**
Hook-and-loop closures and mesh panels add flexibility and comfort.
- ✔ **Versatile**
Low-cut wrist bands for freedom of movement and excellent ClearStart™ watch visibility and operation.
- ✔ **Available Sizes**
XXS – XXL

RF2602
TECHNICAL SAILING CAP

- ✔ Breathable.
- ✔ Quick drying.
- ✔ Retainer cord and clip.
- ✔ Washable.
- ✔ One size fits most.
- ✔ Hydrophobic outer layer.
- ✔ Sweat band for comfort and retention.
- ✔ Black under peak to reduce glare.
- ✔ Adjustable hook-and-loop rear closure for secure fit.
- ✔ Polyester microfibre.

SIZE	HAND SIZE* cm	HAND SIZE* in
Gloves		
XXXXS	18	7
XXXS	19	7 1/2
XXS	20	7 7/8
XS	21	8 1/4
S	22	8 5/8
M	23	9
L	24	9 1/2
XL	25.5	10
XXL	26.5	10 3/8

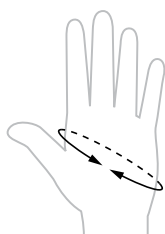



**CL600
SUPERFLEX SAILING SHOE**

- ✔ **Ultra-Light & Super-Flexible**
The perfect combination.
- ✔ **Unrivalled Stability & Comfort**
Internal toe separator and outer bridge strap give you improved stability.
- ✔ **Extra Protection**
Added heel, ankle and toe padding offer more protection.
- ✔ **Available Sizes**
XXXS – XXXL

**CL630
SAILING BOOT**

- ✔ **Tried & True**
Traditional razor-cut sole for performance grip.
- ✔ **Easy Entry**
Side zipper for easy fitting and reinforced neoprene upper for hiking comfort.
- ✔ **Lightweight & Comfortable**
The perfect combo.
- ✔ **Reinforced Comfort**
Padded neoprene upper reinforced for hiking comfort.
- ✔ **Available Sizes**
XXXS – XXXL

**CL620
RACE BOOT**

- ✔ **Race-Ready!**
Hard-wearing, moulded sole with extra heel and toe texturing provides reliable grip and firm footing.
- ✔ **Easy-On**
Side zipper with secure fastener tab for an easy on-and-off and a snug fit.
- ✔ **Reinforced Comfort**
Padded neoprene upper reinforced for hiking comfort.
- ✔ **Available Sizes**
XXS – XXXL

**CL640
OFFSHORE BOOT**

- ✔ **Race-Ready!**
Hard-wearing, moulded sole with extra heel and toe texturing provides reliable grip and firm footing.
- ✔ **Easy-On**
Three-quarter length cut with toggle lock strings for comfort, warmth and protection.
- ✔ **Support & Comfort**
Removable inner soles for added foot support and quick drying.
- ✔ **Available Sizes**
XXS – XXXL

SIZE*	FOOT LENGTH cm	FOOT LENGTH in	EUROPE	US & CANADA MENS	UK MENS	AUSTRALIA MENS	JAPAN MENS	US & CANADA WOMENS	UK WOMENS	AUSTRALIA WOMENS	JAPAN WOMENS
Footwear											
XXXS	21 - 22	8 1/4 - 8 5/8	33 - 34	3	2	2	21	3	2	2	21
XXS	22.5 - 23.5	8 7/8 - 9 1/4	35 - 36	3.5 - 4.5	3 - 4	3 - 4	21 - 22	5 - 6	2.5 - 3.5	3.5 - 4.5	21 - 22
XS	23.5 - 24.5	9 1/4 - 9 5/8	36 - 38	4.5 - 6	4 - 5.5	4 - 5.5	22 - 23.5	6 - 7.5	3.5 - 5	4.5 - 6	22 - 23.5
S	24.5 - 25.5	9 5/8 - 10	38 - 40	6 - 7.5	5.5 - 7	5.5 - 7	23.5 - 25	7.5 - 9	5 - 6.5	6 - 7.5	23.5 - 25
M	25.5 - 26.5	10 - 10 1/2	40 - 43	7.5 - 9	7 - 8.5	7 - 8.5	25 - 27	9 - 10.5	6.5 - 8	7.5 - 9	25 - 27
L	26.5 - 27.5	10 3/8 - 10 3/4	43 - 44	9 - 10.5	8.5 - 10	8.5 - 10	27 - 28	10.5 - 12	8 - 9.5	9 - 10.5	27 - 28
XL	27.5 - 28.5	10 3/4 - 11 1/4	44 - 46.5	10.5 - 12.5	10 - 12	10 - 12	28 - 30	12 - 14	9.5 - 11.5	10.5 - 12.5	28 - 30
XXL	28.5 - 29.5	11 1/4 - 11 5/8	46.5 - 48.5	12.4 - 14	12 - 13.5	12 - 13.5	30 - 31	14 - 15.5	11.5 - 13	12.5 - 14	30 - 31
XXXL	29.5 - 30.5	11 5/8 - 12	48.5 - 50	14 - 15	13.5 - 14	13.5 - 14	-	-	-	-	-

*Typical equivalent country size. Indicative only and subject to variation. Your 'foot length' measurement should be used as the most accurate guide for sizing.



RF4002 GEAR BAG

- ✔ Roomy interior with double zip top flap for easy access.
- ✔ Two end pockets, one with mesh for drainage and ventilation.
- ✔ Adjustable, heavy duty webbing handles with padded grip.
- ✔ Central strap with buckle for securing a jacket or other gear on top.
- ✔ Includes a separate 10-litre waterproof grab bag for your wet gear.
- ✔ Dimensions: H350mm x W650mm x D300mm (H13 3/4" x W25 1/2" x D12")

RF1706 NUMBER STRIP

- ✔ Use as a reference scale for halyard tension, jib lead or main traveller positions.
- ✔ 230mm (9") long.
- ✔ Self-adhesive backing.

CL16 SUNGLASSES STRAP

- ✔ Neoprene strap ends slide directly onto sunglasses temples.

RF4020 PROTEST FLAG

- ✔ Hook-and-loop fastener strips secure the flag around any stay.
- ✔ Rolls up to secure with locking tab, ready to deploy.
- ✔ 230mm x 140mm (9" x 5 1/2").
- ✔ Laser cut ripstop nylon.

RF4025 TELL TAILS (SET OF 3 PAIRS)
RF4026 LEECH TAILS (SET OF 3 PAIRS)

- ✔ Essential guide for proper sail trim.
- ✔ Adhesive patches for attachment to sail.
- ✔ Vivid colour fabric tails for maximum visibility; colour coded for port and starboard.
- ✔ Laser cut ripstop nylon.



Roll-top closure



RF4015

55-LITRE ROLL-TOP DRY CREW BAG

A large, lightweight yet durable carry-all; highly water resistant, protects and keeps all your crew kit dry.

✔ Weather Ready

Secure water-resistant zipper to main compartment with roll-top seal for additional protection from the elements. Lightweight yet durable thermoplastic polyurethane (TPU) fabric with fully welded construction.

✔ Accessory-Friendly

2x fast access outside pockets with water resistant zippers for additional storage.

✔ Travel Equipped

Padded carry handles with additional removable padded over-shoulder strap makes for a comfortable and versatile carry-all.

✔ Outside Dimensions

H300mm x W800mm x D350mm
(H12" x W31 1/2" x D14").

Note: external pocket zip is water resistant, not waterproof. Outside dimensions measured when folded 3x.



RF4014



Adjustable padded harness



RF4013



RF4012



RF4014

55-LITRE DRY BACKPACK

A rugged, highly water resistant roll-top dry bag that is loaded with practical features and big enough for all your sailing, kiting, surfing or paddling gear delivered in a smart, ergonomic backpack that makes packing and travelling a breeze.

- ✔ **Room to Spare**
A big 55-litre capacity with a large opening for ease of packing and handling.
- ✔ **Versatile, Snug Fit**
Fully padded backpack harness, padded straps, and adjustable cross-chest strap for extra comfort and fit. 4x adjustable side compression straps for attaching additional items or cinching when the bag is not full.
- ✔ **Watertight**
Light but durable TPU fabric, leak-proof welded construction with water resistant zipper and reliable fold and clip closure keeps your gear bone dry.
- ✔ **Accessory-Friendly**
Large external accessory pocket with water resistant zipper. Additional pocket inside main bag compartment for additional secure storage.
- ✔ **Outside Dimensions**
H600mm x W430mm x D270mm (H23 1/2" x W17" x D10 1/2")

Note: external pocket zip is water resistant, not waterproof. Outside dimensions measured when folded 3x.



RF4013

30-LITRE DRY BACKPACK

The 30-litre dry backpack combines a water-resistant roll-top seal with the practical features of an ergonomic backpack that makes packing light a cinch.

- ✔ **Versatile, Feature Packed**
Light but durable TPU fabric with fully welded construction. Main compartment with roll-top, side mount closure. Includes fast access front pocket with water resistant zipper and side-mounted accessory loops.
- ✔ **Fully-Adjustable**
Fully padded backpack harness, padded straps, and adjustable cross-chest strap for comfort and fit.
- ✔ **Notebook Friendly**
Padded neoprene sleeve inside main compartment 230mm x 320mm (9" x 12 1/2").
- ✔ **Outside Dimensions**
H500mm x W300mm x D270mm (H19 1/2" x W12" x D10 1/2").

Note: external pocket zip is water resistant, not waterproof. Outside dimensions measured when folded 3x.



RF4012

10-LITRE DRY BAG

A handy compact dry bag that is highly water resistant, the perfect size for protecting personal items.

- ✔ **Secure**
Simple, reliable fold and clip closure keeps everything dry. Removable shoulder strap.
- ✔ **Leak-Proof Construction**
Durable TPU fabric with full welded construction. Clear window allows you to see what is inside.
- ✔ **Outside Dimensions**
H300mm x W200mm (H12" x W8") when folded 3x.



Large quick-view displays

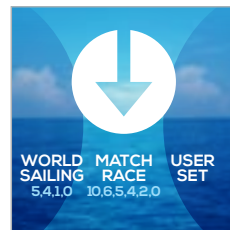

Selectable start sequences on digital watches



Re-synchronisation feature



Digital watches water resistant to 5ATM / 50m / 150ft



Analogue watches water resistant to 10ATM / 100m / 300ft



Mast mounting option



CLEARSTART™ WATCHES

INNOVATIVE RACE FUNCTIONS WITH BOLD STYLING

The Clearstart™ Watch range combines contemporary styling with true sailing functionality. Featuring large buttons, easy to read displays and advanced, intuitive programming, Clearstart™ Timer and Watches are specifically designed with the racing sailor in mind. Developed in collaboration with some of the world's top sailors, they set the standard on and off the water. If you're looking for that competitive edge, the difference is Clearstart™.

Big, Quick-View Displays

The digital Clearstart™ range features oversized digit displays for quick & easy viewing so that you never have to take your hand off the helm. The RF4056 Analogue Clearstart™ watch features hands with cutouts so they never hide the chronograph timers.

Water & Shock Resistant

Designed to survive the rigours of competitive sailing, digital Clearstart™ Watches and Timer are water resistant, rated at 5ATM and are highly shock-resistant. The Analogue Clearstart™ watch is also water resistant, rated to 10ATM with a hard mineral crystal lens.

DIGITAL WATCH & TIMER FUNCTIONS

Pre-programmed Race Sequence Sounds

ClearStart™ sound signals let you know exactly where you are in the start sequence without looking at the display. Pre-programmed with World Sailing 5-4-1-0 and match-racing start sequences, users can also program ClearStart™ for other count down sequences.

End of Sequence – Count Down or Count Up

Depending on the user's preference, the ClearStart™ can be set up to repeat the count down at the end of the sequence for general recall restarts, or to start counting up, to track elapsed time.

Multi-Line Display with Real-Time

No need to switch between 'count down' and 'time' modes because the actual current time is displayed below the count down time on the multi-line ClearStart™ display.

Daily Life Functionality

From waking up to working out, a ClearStart™ watch is also great for everyday activities. Standard modes include 12 or 24-hour time format, date in day/month or month/day format, daily alarm and chronograph stop watch.

Luminescent Backlight

Bright, full-face electroluminescent backlighting is easy to read at night and can be turned on temporarily for a quick view.



RF4050



RF4056

RF4050
CLEARSTART™ RACE TIMER

- ✔ 65mm (2 9/16") diameter face.
- ✔ Oversized 16mm (5/8") digit display.
- ✔ Rotating face.
- ✔ Wrist/hull/mast/boom mount options.
- ✔ 30mm (1 1/8") wide stretch nylon band with security loop.
- ✔ Flush fit buckle.
- ✔ Dual batteries.
- ✔ Extra large easy-press silicon buttons – highlighted Start/Stop button.
- ✔ Weight 92g (3.3oz).

FEATURES
RACE MODE

- ✔ Multiple start sequence options – World Sailing 5,4,1,0, match racing, user set.
- ✔ SYNChronisation function – resynchronise if you start the countdown late.
- ✔ Multi-line display – start sequence + time.
- ✔ Loud intuitive countdown and start sound signals.
- ✔ Countdown repeat, or count down and up (for elapsed race time).
- ✔ Separate fast access race and time mode scrolling.
- ✔ Water resistant to 5 ATM (50m/150ft).

RF4056
CLEARSTART™ ANALOGUE WATCH

- ✔ Analogue quartz chronograph movement.
- ✔ 43mm (1 11/16") brushed matt black stainless steel case.
- ✔ Hard mineral crystal lens.
- ✔ 12 and 24 hour time with date window.
- ✔ Stopwatch (60 sec and 10 min).
- ✔ Timer (5 minute countdown).
- ✔ Water resistant to 10 ATM (100m/300ft).
- ✔ Weight 90g (3.2oz).



RF4055



RF4055A



RF4055B

RF4055

50MM SAILING WATCHES

- ✔ Durable, ultra-clear mineral crystal lens.
- ✔ 50mm (2") diameter face.
- ✔ Oversized 13mm (1/2") digit display.
- ✔ Large easy-press buttons.
- ✔ Stainless steel buckle and security loop.
- ✔ Flexible polymer band.
- ✔ Stainless steel back.
- ✔ Weight 65g (2.3oz).

FEATURES

RACE MODE

- ✔ Multiple start sequence options – World Sailing 5,4,1,0, match racing, user set.
- ✔ SYNChronisation function – resynchronise if you start the countdown late.
- ✔ Multi-line display – start sequence + time.
- ✔ Loud intuitive countdown and start sound signals.
- ✔ Countdown repeat, or count down and up (for elapsed race time).
- ✔ Separate fast access race and time mode scrolling.
- ✔ Water resistant to 5 ATM (50m/150ft).

FEATURES

STANDARD FEATURES

- ✔ Time, hours/minutes/seconds – 12 or 24 hour format.
- ✔ Month/day or day/month format.
- ✔ Daily alarm.
- ✔ Chronograph - including hours and time of the day.
- ✔ Luminescent backlight.
- ✔ Battery saving mode – light can be turned off.
- ✔ Shock resistant.



RF4054B



RF4054A



RF4054

**RF4054
40MM SAILING WATCHES**

- ✔ Durable, ultra-clear mineral crystal lens.
- ✔ 40mm (1 9/16") diameter face.
- ✔ Oversized 10mm (3/8") digit display.
- ✔ Recommended wrist circumference 13cm - 18.5cm (5 1/8" - 7 1/4").
- ✔ Large easy-press buttons.
- ✔ Stainless steel buckle and security loop.
- ✔ Flexible polymer band.
- ✔ Stainless steel back.
- ✔ Weight 42g (1.5oz).

**FEATURES
RACE MODE**

- ✔ Multiple start sequence options – World Sailing 5,4,1,0, match racing, user set.
- ✔ SYNChronisation function – resynchronise if you start the countdown late.
- ✔ Multi-line display – start sequence + time.
- ✔ Loud intuitive countdown and start sound signals.
- ✔ Countdown repeat, or count down and up (for elapsed race time).
- ✔ Separate fast access race and time mode scrolling.
- ✔ Water resistant to 5 ATM (50m/150ft).

**FEATURES
STANDARD FEATURES**

- ✔ Time, hours/minutes/seconds – 12 or 24 hour format.
- ✔ Month/day or day/month format.
- ✔ Daily alarm.
- ✔ Chronograph - including hours and time of the day.
- ✔ Luminescent backlight.
- ✔ Battery saving mode – light can be turned off.
- ✔ Shock resistant.

SHACKLES



☑ Many shapes and sizes to suit any application.

☑ Coined shackle pin head - some models with hole for seizing wire.

☑ Grade 316 stainless steel bodies and pins.

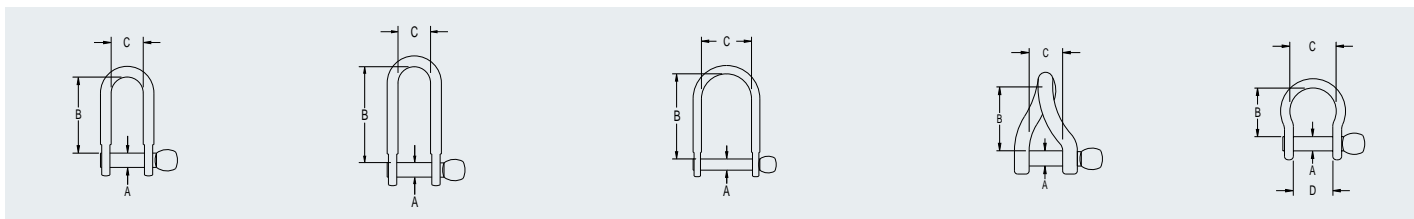

PRODUCT No.	A mm	B mm	C mm	D mm	U.D.L.*1 B.L. kg	P.L.*1 B.L. kg	WEIGHT g	A in	B in	C in	D in	U.D.L.*1 B.L. lb	P.L.*1 B.L. lb	WEIGHT oz
Standard D														
RF1851	3.2	12	9	-	375	280	2	1/8	15/32	11/32	-	825	620	0.1
RF1806	4.0	16	10	-	800	600	5	5/32	5/8	13/32	-	1760	1320	0.2
RF616	4.8	18	11	-	1200	800	15	3/16	23/32	7/16	-	2640	1760	0.5
RF617	6.4	22	14	-	2300	1400	25	1/4	7/8	9/16	-	5070	3090	0.9
RF617H*2	6.4	22	14	-	2300	1400	25	1/4	7/8	9/16	-	5070	3090	0.9
RF618	7.9	29	16	-	3600	2700	50	5/16	1 5/32	5/8	-	7940	5950	1.8
RF618H*2	7.9	29	16	-	3600	2700	50	5/16	1 5/32	5/8	-	7940	5950	1.8
RF619*2	9.5	38	17	-	5400	3600	80	3/8	1 1/2	21/32	-	11900	7940	2.8
RF620*2	12.7	42	19	-	7700	7500	130	1/2	1 31/32	3/4	-	16980	16530	4.6
RF1035	15.9	47	25	-	14000	11000	280	5/8	1 25/32	1	-	30860	24250	9.9
Long D														
RF621	4.0	26	10	-	800	600	10	5/32	1 1/32	13/32	-	1760	1320	0.4
RF622	4.8	31	11	-	1200	800	15	3/16	1 7/32	7/16	-	2640	1760	0.5
RF623	6.4	44	15	-	2300	1400	30	1/4	1 21/32	19/32	-	5070	3090	1.1
RF624	7.9	55	17	-	3600	2700	60	5/16	2 5/32	21/32	-	7940	5950	2.1
RF625*2	9.5	60	17	-	5400	3600	90	3/8	2 3/8	21/32	-	11900	7940	3.2
RF626*2	12.7	72	18	-	7700	7500	155	1/2	2 27/32	23/32	-	16980	16530	5.5
Wide														
RF1850S	3.2	11	13	-	500	280	2	1/8	7/16	1/2	-	1100	620	0.1
RF1852	4.8	29	20	-	1200	700	15	3/16	1 5/32	25/32	-	2640	1540	0.5
RF1853	6.4	39	31	-	2300	1100	26	1/4	1 17/32	1 7/32	-	5070	2430	0.9
RF639	7.9	51	28	-	3400	1700	70	5/16	2	1 3/32	-	7480	3740	2.5
RF640	9.5	56	29	-	5400	3600	95	3/8	2 7/32	1 5/32	-	11900	7940	3.4
RF641*2	12.7	68	33	-	7700	5500	170	1/2	2 11/16	1 5/16	-	16980	12130	6.0
Twisted														
RF627	4.0	23	9	-	800	600	5	5/32	29/32	11/32	-	1760	1320	0.2
RF628	4.8	28	10	-	1200	800	15	3/16	1 3/32	13/32	-	2640	1760	0.5
RF629	6.4	39	13	-	2300	1400	30	1/4	1 17/32	1/2	-	5070	3090	1.1
RF630	7.9	48	16	-	3600	2700	65	5/16	1 7/8	5/8	-	7940	5950	2.3
RF631*2	9.5	54	19	-	5400	3600	90	3/8	2 1/8	3/4	-	11900	7940	3.2
RF632*2	12.7	65	19	-	7700	7500	165	1/2	2 9/16	3/4	-	16980	16530	5.8
Bow														
RF613S*3	3.0	12	9	6.4	550	280	3	1/8	15/32	11/32	1/4	1210	620	0.1
RF633	4.0	15	17	11.0	800	600	5	5/32	9/16	9/16	7/16	1760	1320	0.2
RF634	4.8	18	14	13.0	1200	800	10	3/16	23/32	9/16	1/2	2640	1760	0.4
RF635	6.4	21	19	16.0	2300	1400	20	1/4	13/16	3/4	5/8	5070	3090	0.7
RF636	7.9	27	22	16.0	3600	2700	45	5/16	1 1/16	7/8	5/8	7940	5950	1.6
RF638*2	7.9	27	22	16.0	3600	2700	45	5/16	1 1/16	7/8	5/8	7940	5950	1.6
RF637*2	9.5	52	36	21.0	5400	3600	90	3/8	2 1/16	1 13/32	13/16	11900	7940	3.2

*1 UDL BL - The "Uniformly Distributed Load" breaking load of the shackle; the load is applied across the full span of the shackle pin.
 PL BL - The "Point Load" breaking load of the shackle; the load is only applied at the centre or one side of the shackle pin.
 *2 Shackle pins drilled for seizing wire
 *3 RF613S has a slotted head.



- ✓ Slotted head shackle pins are low profile to prevent snagging on ropes etc.
- ✓ Lightweight clevis pin shackles use a split ring for security.

- ✓ Halyard shackles have a lever action for easy finger opening and closing. They also have a keyed pin for pin retention and spring engagement to retain pin in closed position.

- ✓ RF1320R shackle key suits both coined and slotted shackle pins, and small nylon-insert nuts.
- ⚙️ Grade 316 stainless steel bodies and pins.

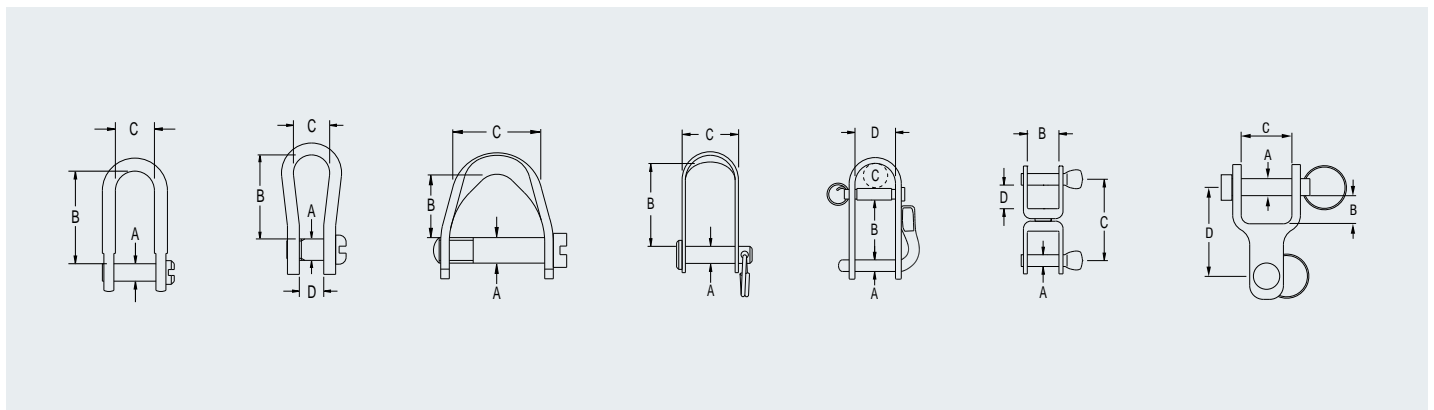

PRODUCT No.	A	B	C	D	U.D.L.*1	P.L.*1	WEIGHT	A	B	C	D	U.D.L.*1	P.L.*1	WEIGHT	
	mm	mm	mm	mm	B.L.	B.L.						B.L.	B.L.		lb
Slotted Pin															
RF615	4.0	16.0	10.0	-	850	650	5	5/32	5/8	13/32	-	1870	1430	0.2	
RF615A	4.0	13.0	8.0	-	850	700	7	5/32	1/2	5/16	-	1870	1540	0.2	
RF150	4.8	18.0	12.0	-	1500	900	10	3/16	23/32	15/32	-	3300	1980	0.4	
RF806S	4.8	11.5	16.0	-	950	700	10	3/16	7/16	5/8	-	2090	1540	0.4	
RF707S	4.8	17.0	18.0	-	1200	700	10	3/16	21/32	23/32	-	2640	1540	0.4	
RF614	4.8	19.0	10.0	5.0	1300	1300	5	3/16	13/32	3/8	3/16	2860	2860	0.2	
RF151	6.4	22.0	16.0	-	2300	1400	20	1/4	7/8	5/8	-	5070	3090	0.7	
RF152	7.9	29.0	17.0	-	3600	2700	45	5/16	1 5/32	21/32	-	7940	5950	1.6	
Lightweight Clevis Pin															
RF807	4.8	20.0	14.0	-	700	-	10	3/16	25/32	9/16	-	1540	-	0.4	
Halyard															
RF1032	4.8	22.0	10.0	15.0	1200	900	30	3/16	7/8	13/32	19/32	2650	1980	1.1	
RF1033	6.4	32.0	13.0	19.0	1800	1400	55	1/4	1 1/4	1/2	3/4	3960	3080	1.9	
RF1034	7.9	39.0	18.5	20.0	2200	1800	90	5/16	1 17/32	23/32	25/32	4840	3960	3.2	
Swivel															
RF576	4.0	10.0	22.0	6.0	500	350	10	5/32	13/32	7/8	15/64	1100	770	0.4	
RF120	4.8	12.0	32.0	8.7	650	650	20	3/16	15/32	1 1/4	11/32	1430	1430	0.7	
RF173	6.4	15.0	42.0	11.9	1100	700	40	1/4	19/32	1 21/32	19/32	2420	1540	1.4	
RF75*2	7.9	17.0	60.0	15.8	2300	2100	15	5/16	21/32	2 3/8	5/8	5070	4620	0.5	
Two-Way Link															
RF815	5.0	5.2	10.0	19.0	1100	900	14	3/16	7/32	13/32	3/4	2425	1980	0.5	
RF816	6.0	6.7	12.2	22.6	1200	1000	21	1/4	1/4	15/32	7/8	2650	2200	0.7	
Shackle Key															
RF1320R	Shackle key and multi-purpose tool. Suits coined and slotted head shackle pins. Features sockets for 3/16" & 1/4" nuts. Screwdriver tip. Hollow end ideal for tightening drain plugs. Red plastic grip handle.						90								3.2

*1 UD.L. BL - The "Uniformly Distributed Load" breaking load of the shackle; the load is applied across the full span of the shackle pin.

PL. BL - The "Point Load" breaking load of the shackle; the load is only applied at the centre or one side of the shackle pin.

*2 RF75 swivel shackle has stainless steel ball bearings.

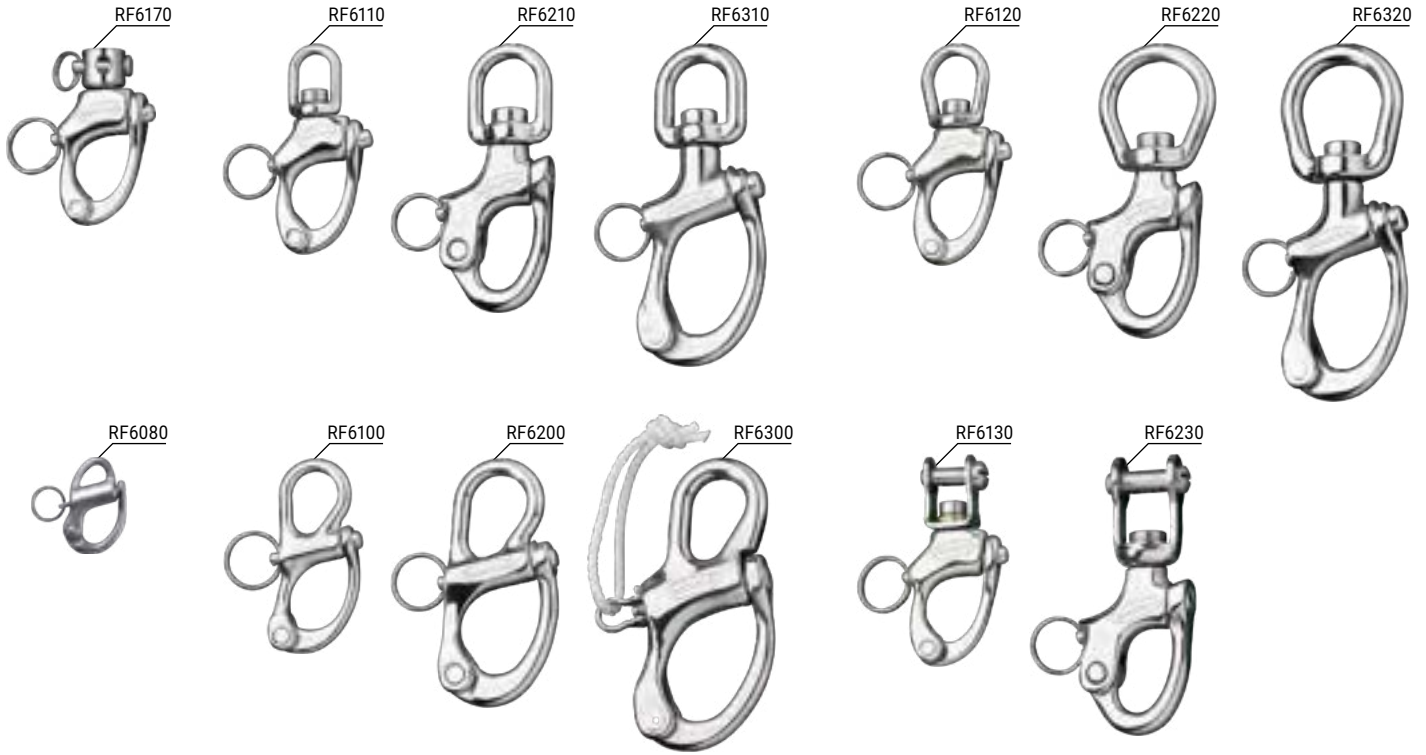

- ✔ Fixed or swivel heads.
- ✔ Heavy duty plunger springs and precision components ensure dependable service.
- ✔ Body and hasp profiles are designed for easy clearance of lines and fittings when released.
- ✔ High strength-to-weight ratio.
- ✔ Stainless steel is used throughout for excellent corrosion resistance.
- ✔ Split ring on plunger pin is spot welded for security.
- ✔ A lanyard can be attached to the plunger pin for easy opening.
- ✔ RF6170 is a snap shackle adapter for blocks with a 5mm (3/16") pin.
- ✔ Grade 15-5PH investment cast stainless steel body and hasp.
- ✔ Grade 316 stainless steel plunger pin and spring.

Replacement Plunger Pin Kits

RF6160	Suits RF6110, RF6120, RF6130, RF6170
RF6161	Suits RF6100, RF6111
RF6260	Suits RF6200
RF6262	Suits RF6210, RF6220, RF6230, RF6230A
RF6360	Suits RF6310, RF6320, RF6321
RF6361	Suits RF6300
RF6461	Suits RF6411
RF6561	Suits RF6511

PRODUCT No.	HEAD TYPE	A	B	C	D	M.W.L.	B.L.	WEIGHT	A	B	C	D	M.W.L.	B.L.	WEIGHT
		mm	mm	mm	mm	kg	kg	g	in	in	in	in	lb	lb	oz
Series 80															
RF6080	Fixed bail	6.2	4.7	32	-	75	150	10	1/4	3/16	1 1/4	-	165	330	0.4
Series 100															
RF6100	Fixed bail	16	15.0	66	-	1000	2000	43	5/8	19/32	2 19/32	-	2205	4410	1.5
RF6110	Small swivel bail	16	10.0	69	-	850	1700	50	5/8	13/32	2 23/32	-	1875	3750	1.8
RF6120	Large swivel bail	16	13.0	73	-	750	1500	57	5/8	1/2	2 7/8	-	1655	3310	2.0
RF6130	Swivel shackle	16	6.4	72	13	750	1500	64	5/8	1/4	2 27/32	1/2	1655	3310	2.3
RF6170	Block head adapter	16	5.0	60	-	500	1000	49	5/8	3/16	2 3/8	-	1105	2210	1.7
Series 200															
RF6200	Fixed bail	20	19.0	85	-	1100	2200	100	13/16	3/4	3 11/32	-	2425	4850	3.5
RF6210	Small swivel bail	16	16.0	92	-	1600	3200	113	5/8	5/8	3 5/8	-	3530	7060	4.0
RF6220	Large swivel bail	16	25.0	101	-	1100	2200	120	5/8	1	3 31/32	-	2425	4850	4.2
RF6230	Swivel shackle	16	7.9	95	17.5	1100	2200	120	5/8	5/16	3 3/4	11/16	2425	4850	4.2
Series 300															
RF6300	Fixed bail	26	19.0	100	-	2000	4000	155	1 1/32	3/4	3 15/16	-	4410	8820	5.5
RF6310	Small swivel bail	26	16.0	110	-	1800	3600	142	1 1/32	5/8	4 11/32	-	3970	7940	5.0
RF6320	Large swivel bail	26	26.0	122	-	1350	2700	170	1 1/32	1 1/32	4 3/4	-	2975	5950	6.0

TRIGGERSNAPS™ & TRUNNION SNAP SHACKLES

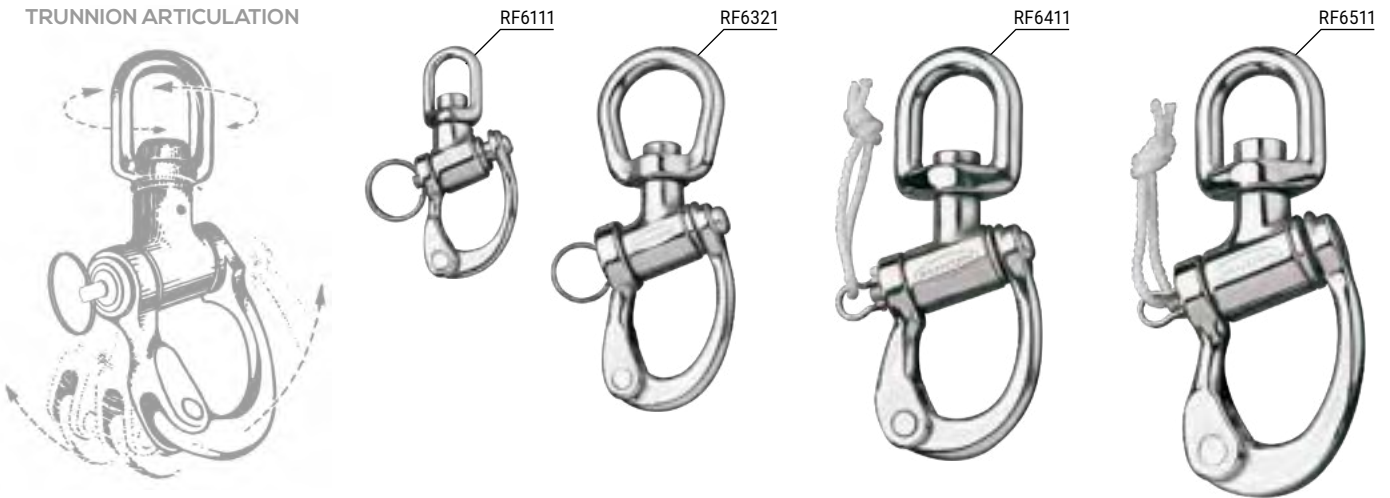
TRUNNION ARTICULATION

- ✔ Trunnion swivel head allows both 360° rotation and side to side articulation.
- ✔ Small and large bail versions
- ✔ RF1322 release spike with shackle key for safe release of Triggersnaps™ while under load.
- ✔ Triggersnaps™ are stamped with a production code for traceability.
- ✔ Triggersnaps™ are individually proof-load tested.
- ✔ Heat treated grade 15-5PH investment cast stainless steel body, bail, latch and trigger.
- ✔ Grade 316 stainless steel rivets and spring.

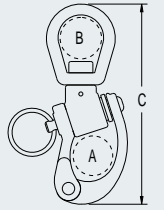
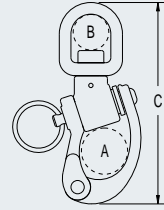
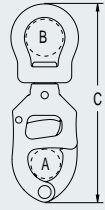
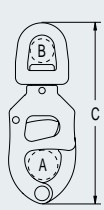

PRODUCT No.	HEAD TYPE	A	B	C	M.W.L.	B.L.	WEIGHT	A	B	C	M.W.L.	B.L.	WEIGHT
		mm	mm	mm	kg	kg	g	in	in	in	lb	lb	oz
Triggersnaps™													
RF7110	Series 100, small swivel bail	14	9	80	1000	2000	60	9/16	11/32	3 5/32	2205	4410	2.1
RF7120	Series 100, large swivel bail	14	18	89	1000	2000	66	9/16	23/32	3 1/2	2205	4410	2.3
RF7210	Series 200, small swivel bail	16	13	97	1600	3200	106	5/8	1/2	3 13/16	3530	7060	3.7
RF7220	Series 200, large swivel bail	16	22	108	1600	3200	116	5/8	7/8	4 1/4	3530	7060	4.1
RF7310	Series 300, small swivel bail	19	16	114	2400	4800	170	3/4	5/8	4 1/2	5290	10580	6.0
RF7320	Series 300, large swivel bail	19	25	123	2400	4800	194	3/4	31/32	4 27/32	5290	10580	6.8
RF1322	Aluminium alloy release spike with shackle key	-	18	150	-	-	78	-	23/32	5 29/32	-	-	2.8

Trunnion Snap Shackles

RF6111	Series 100, small swivel bail	16	10	70	750	1500	57	5/8	13/32	2 3/4	1655	3310	2.0
RF6321	Series 300, large swivel bail	26	26	122	1350	2700	198	1 1/32	1 1/32	4 13/16	2975	5950	7.0
RF6411	Series 400, small swivel bail	32	25	137	3000	6000	369	1 1/4	1	5 13/32	6615	13230	13.0
RF6511	Series 500, small swivel bail	36	22	150	3750	7500	454	1 13/32	7/8	5 29/32	8270	16540	16.0

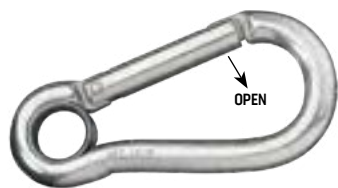

CARABINER HOOKS, NON-LOCKING

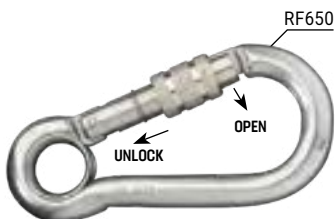

CARABINER HOOK, LOCKING



QUICKLINKS



ROUND RINGS



D-RING



SNAP HOOK

- ✔ Carabiner hooks have ferrule lined eyes to retain the fixed line.
- ✔ RF650 carabiner hook opens inwards and has a threaded locking sleeve for added security.
- ✔ Quicklinks have large openings and secure threaded locking sleeves.
- ✔ RF16 D-ring suits use with 50mm (2") webbing.

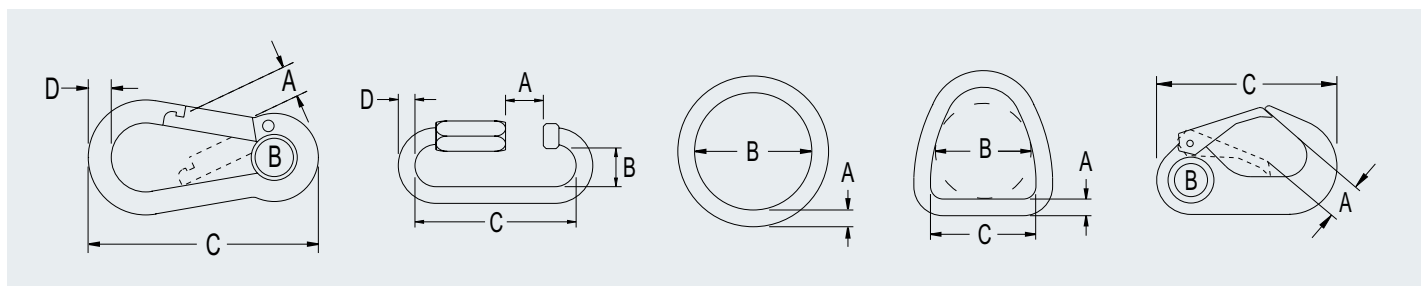

PRODUCT No.	TYPE	A mm	B mm	C mm	D mm	M.W.L. kg	B.L. kg	WEIGHT g	A in	B in	C in	D in	M.W.L. lb	B.L. lb	WEIGHT oz	
Carabiner Hooks - Non-Locking																
RF2355	-	9.0	9.0	60	6	-	520	28	11/32	11/32	2 3/8	1/4	-	1145	1.0	
RF652	-	11.0	11.0	80	8	-	800	68	7/16	7/16	3 1/8	5/16	-	1760	2.4	
RF653	-	15.0	15.0	100	10	-	1200	129	19/32	19/32	3 15/16	13/32	-	2640	4.6	
Carabiner Hook - Threaded Locking Sleeve																
RF650	-	13.0	14.0	100	10	-	1200	134	17/32	17/32	3 15/16	13/32	-	2640	4.7	
Quicklinks																
RF711	-	5.5	11.5	32	4	-	1400	12	3/16	7/16	1 1/4	5/32	-	3085	0.4	
RF712	-	7.5	14.5	45	6	-	3250	35	5/16	9/16	1 3/4	1/4	-	7165	1.2	
RF713	-	11.0	17.5	58	8	-	5500	79	7/16	11/16	2 5/16	5/16	-	12125	2.7	
RF714	-	12.0	20.5	69	10	-	9000	140	15/32	13/16	2 11/16	13/32	-	19840	4.9	
Rings																
RF122	Round	4.0	38.0	-	-	180	1100	12	5/32	1 1/2	-	-	396	2420	0.4	
RF123	Round	5.0	25.4	-	-	600	2200	14	3/16	1	-	-	1320	4840	0.5	
RF48	Round	6.0	25.4	-	-	900	3000	15	1/4	1	-	-	1980	6600	0.5	
RF124	Round	6.0	38.0	-	-	650	3000	40	1/4	1 1/2	-	-	1430	6600	1.4	
RF125	Round	8.0	42.5	-	-	700	3500	55	5/16	1 5/8	-	-	1540	7700	1.9	
RF16	D-ring	8.0	45.0	50	-	600	1200	75	5/16	1 3/4	2	-	1320	2640	2.7	
Snap Hook																
RF533	-	10.0	9.0	51	-	180	360	25	13/32	11/32	2	-	395	790	0.9	



SWIVELS
See page 203 for swivel shackles

S-HOOKS

BECKETTS

SISTER CLIPS

Swivels are used in conjunction with blocks and rigging systems to provide articulation and rotation (not suitable for high speed rotating applications).

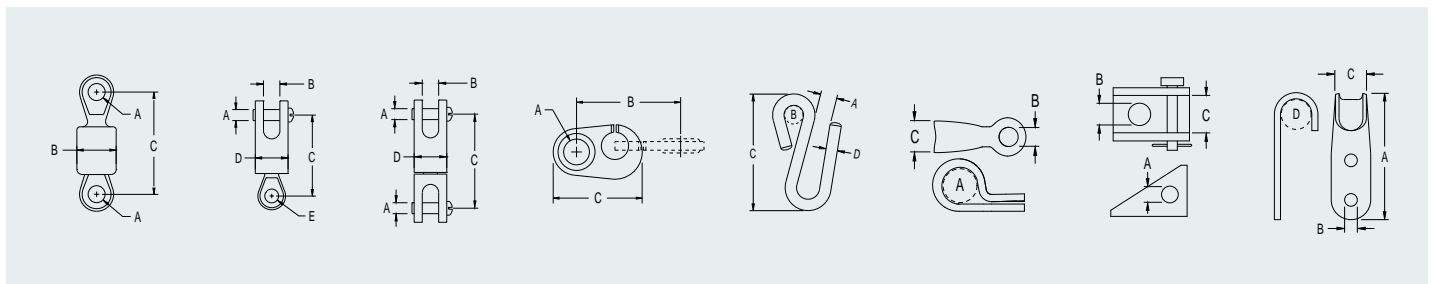
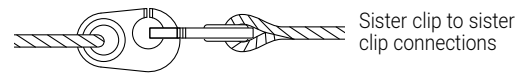

PRODUCT No.	TYPE	A mm	B mm	C mm	D mm	E mm	B.L. kg	WEIGHT g	A in	B in	C in	D in	E in	B.L. lb	WEIGHT oz
Swivels - Ball Bearing															
RF78*		8.1	19.1	51.8	-	-	1000	65	5/16	3/4	2 3/32	-	-	2200	2.3
RF78A		6.4	9.6	54.0	19.0	-	1700	80	1/4	3/8	2 1/8	3/4	-	3740	2.8
RF78B*		6.4	9.6	44.3	19.0	8.1	1700	60	1/4	3/8	1 3/4	3/4	5/16	3740	2.1
RF79		7.9	12.7	89.8	25.1	16.0	2600	190	5/16	1/2	3 17/32	1	5/8	5720	6.7
Sister Clips															
RF536		7.0	27.0	24.0	-	-	70	5	9/32	1 1/16	15/16	-	-	150	0.2
RF89		10.0	43.0	37.0	-	-	250	10	13/32	1 11/16	1 7/16	-	-	550	0.4
RF2665		15.0	60.0	58.0	-	-	1800	81	19/32	2 3/8	2 1/4	-	-	3960	2.9
S-Hooks															
RF50		10.0	6.8	44.0	4.8	-	250	14	13/32	1/4	1 3/4	3/16	-	550	0.5
RF48A		10.0	9.0	62.0	6.0	-	400	35	13/32	11/32	2 7/16	1/4	-	880	1.2
RF49		12.0	11.0	76.0	8.0	-	600	65	15/32	7/16	3	5/16	-	1320	2.3
RF51		15.0	16.0	87.0	9.5	-	800	110	19/32	5/8	3 7/16	3/8	-	1760	3.9
Becketts															
RF88	Hook becket	50.5	5.0	13.5	8.0	-	-	13	2	3/16	17/32	5/16	-	-	0.5
RF1050	Eye becket	8.0	5.0	9.0	-	-	-	6	5/16	3/16	11/32	-	-	-	0.2
RF1051	Eye becket	8.0	6.0	9.0	-	-	-	6	5/16	1/4	11/32	-	-	-	0.2
RF1052	Fork becket / block anchor	5.0	5.0	11.5	-	-	-	9	3/16	3/16	7/16	-	-	-	0.3
RF1053	Fork becket / block anchor	5.0	6.0	14.0	-	-	-	9	3/16	1/4	9/16	-	-	-	0.3

*Eye thickness = 6.4mm (1/4")

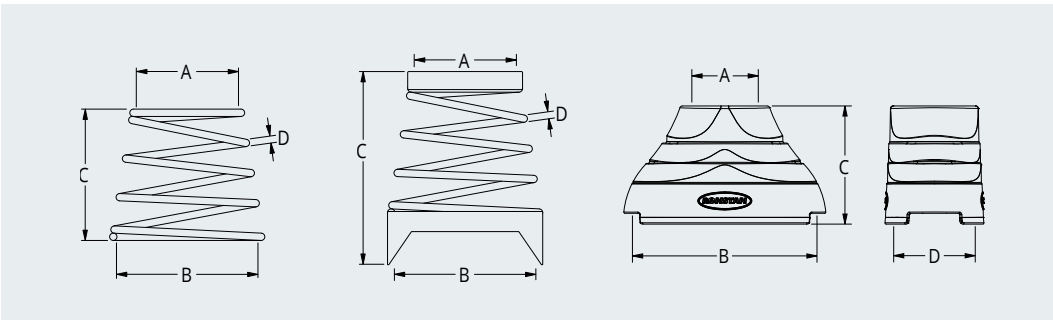

- ☑ RF324, RF324-1, RF324-2, RF324-3, RF328 include top and bottom acetal collars.
- ⬆ Springs and boots are used to support blocks in an upright position.
- 🌀 Grade 316 stainless steel springs.

PRODUCT No.	DESCRIPTION	A	B	C	D	WEIGHT	A	B	C	D	WEIGHT
		mm	mm	mm	mm	g	in	in	in	in	oz
Stand-Up Springs											
RF318*1	Stand-up spring, suits Series 15 and Series 20 Utility blocks with saddle RF498	16	23	22	1	3	5/8	7/8	7/8	1/32	0.1
RF319	Stand-up spring	16	16	32	2	3	5/8	5/8	1 1/4	3/32	0.1
RF321*1	Stand-up spring, suits Series 40 Utility blocks (use saddle RF134 or RF134A) or Series 50 (use saddle RF1055)	16	24	41	2	9	5/8	15/16	1 5/8	3/32	0.3
RF323*1	Stand-up spring, suits Series 30 Utility blocks and Orbit Blocks™ with saddle RF134/RF134A	19	25	32	1	4	3/4	1	1 1/4	1/32	0.1
RF324	Stand-up spring, suits Series 60 & 75 Core Blocks™ and Orbit Blocks™ with padeye RF2433-09	20	30	81	4	80	3/4	1 3/16	3 3/16	5/32	2.8
RF324-1	Stand-up spring, suits Series 60 & 75 Core Blocks™ and Orbit Blocks™	20	24	103	3	60	3/4	15/16	4 1/16	1/8	2.1
RF324-2	Stand-up spring, suits Series 60 & 75 Core Blocks™ and Orbit Blocks™, S26 & S30 traveller cars	20	38	89	4	60	3/4	1 1/2	3 1/2	5/32	2.1
RF324-3*2	Stand-up spring, suits Series 60, 75 & 100 Core Blocks™ and Orbit Blocks™, S26 traveller cars	20	38	94	4	60	3/4	1 1/2	3 11/16	5/32	2.1
RF328	Stand-up spring, suits S100 Orbit Blocks™ with padeye RF2429-10	47	72	95	4	120	1 7/8	2 7/8	3 3/4	5/32	4.2
Stand-Up Bases & Boots											
RF2454	Stand-up base, suits S40 Orbit Blocks™ - includes RF134 stainless steel saddle	17	42	28	19	11	5/8	1 5/8	1 1/8	3/4	0.4
RF2455	Stand-up base, suits S55 Orbit Blocks™ - includes RF1055 stainless steel saddle	20	53	35	23	26	3/4	2 1/8	1 3/8	15/16	0.9
RF2454B	Stand-up boot, suits S40 Orbit Blocks™ - boot only	17	42	28	19	6	5/8	1 5/8	1 1/8	3/4	0.2
RF2455B	Stand-up boot, suits S55 Orbit Blocks™ - boot only	20	53	35	23	11	3/4	2 1/8	1 3/8	15/16	0.4

*1 Tapered spring.
*2 Suits no end cap version Series 26 traveller cars.



PADEYES



- Grade 316 stainless steel.
- RF2429-xx - Grade 15-5PH stainless steel.

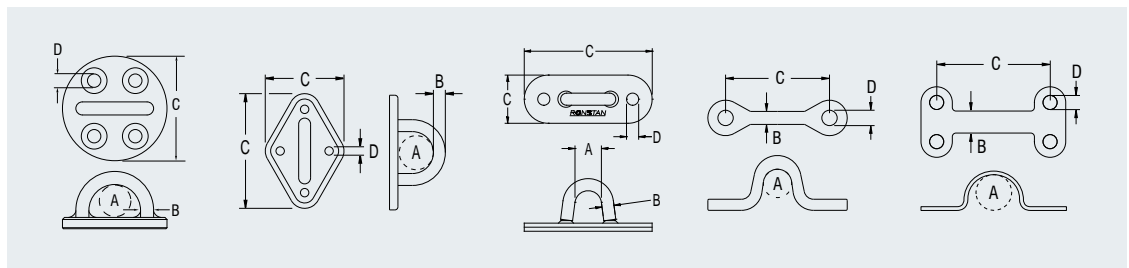

PRODUCT No.	DESCRIPTION	A	B	C	D	B.L.	WEIGHT	A	B	C	D	B.L.	WEIGHT
		mm	mm	mm	mm	kg	g	in	in	in	in	lb	oz
Padeyes - Fixed, Round													
RF2429-02	2 mounting holes	7.2	5.0	34.0	6.4	1500**	26	9/32	3/16	1 5/16	1/4	3310**	0.9
RF2429-06	4 mounting holes	16.0	7.3	50.0	6.4	4000**	82	5/8	5/16	2	1/4	8800**	2.9
RF2429-08	4 mounting holes	17.2	10.0	57.7	8.3	6000**	127	43/64	25/64	2 1/4	21/64	13200**	4.5
RF2429-10	4 mounting holes	21.1	11.5	72.3	10.2	9000**	240	53/64	7/16	2 3/4	13/32	19800**	8.5
Padeyes - Fixed, Diamond Base													
RF87	Straight sided, concave underside	10.0	5.0	51 x 19	5.1	-	15	3/8	3/16	2 x 3/4	3/16	-	0.5
RF529*	Includes nylon mounting pad	18.0	8.0	75 x 51	6.4	2000	100	23/32	5/16	3 x 2	1/4	4400	4.0
RF415	Includes nylon mounting pad	21.0	8.0	75 x 51	5.0	1000	75	13/16	5/16	3 x 2	3/16	2200	2.7
RF44	Includes nylon mounting pad	22.0	11.0	94 x 60	6.7	2000	130	7/8	7/16	3 11/16 x 2 3/8	1/4	4400	4.6
RF416		25.0	6.4	83 x 35	4.8	800	40	1	1/4	3 1/4 x 1 3/8	3/16	1760	1.4
Saddles - Narrow													
RF133		9.0	4.0	27.0	4.8	-	2	3/8	5/32	1 1/16	3/16	-	0.1
RF134		14.0	5.1	36.6	4.5	-	5	9/16	3/16	1 7/16	3/16	-	0.2
RF134A	Countersunk holes	14.0	5.1	36.6	5.0	-	5	9/16	3/16	1 7/16	3/16	-	0.2
RF498		12.0	3.2	27.7	4.3	-	4	15/32	1/8	1 3/32	5/32	-	0.1
RF528		12.0	6.8	44.5	8.1	-	25	15/32	9/32	1 23/32	5/16	-	0.9
RF1054		18.0	7.0	60.0	8.4	-	35	23/32	9/32	2 3/8	5/16	-	1.2
RF1055		16.0	5.8	43.0	6.6	-	15	5/8	7/32	1 11/16	1/4	-	0.5
Saddles - Flared Top													
RF94		6.0	9.0	27.0	5.0	-	3	1/4	11/32	1 1/16	3/16	-	0.1
RF94A		5.0	5.8	29.0	5.0	-	3	3/16	7/32	1 1/8	3/16	-	0.1
RF96		10.0	8.3	29.0	6.4	-	5	3/8	5/16	1 1/8	1/4	-	0.2
RF148		15.0	11.0	40.0	6.5	-	8	9/32	7/16	1 5/8	1/4	-	0.3
RF291		12.0	9.0	31.8	5.3	-	7	1/2	11/32	1 1/4	3/16	-	0.2
RF4714	4 fixing points	9.0	8.0	32.0 / 19.5	5.0	-	9	11/32	5/16	1 1/4 / 3/4	3/16	-	0.3
RF5003		7.0	9.0	27.0	5.0	-	4	1/4	3/8	1 1/16	3/16	-	0.1
RF5013		15.0	12.5	38.1	5.0	-	8	5/8	1/2	1 1/2	3/16	-	0.3
RF5023		18.0	14.0	51.0	6.6	-	11	3/4	9/16	2	1/4	-	0.4
Saddles - Ferrule Eye													
RF499		9.4	4.9	27.7	4.3	-	4	3/8	3/16	1 3/32	5/32	-	0.1
RF1056		16.3	8.8	60.0	8.4	-	40	5/8	5/16	2 3/8	5/16	-	1.4
RF1057		13.0	6.8	45.7	6.6	-	18	1/2	1/4	1 3/4	1/4	-	0.6
RF1058		10.0	9.0	36.6	5.1	-	11	3/8	11/32	1 7/16	3/16	-	0.4

* Turned U-Bolt with a pad eye base. Thread size is 6.4mm (1/4" UNC). Suits maximum deck thickness of 22mm (7/8")
 ** A4-80 DIN7991 grade fasteners recommended to achieve BL



© Sport Sailing Photography



REMOVABLE

- RF2433-09 4 X M6
- RF2433-10 4 X M8
- RF2435-14 4 X M10



REMOVABLE, NON-TUMBLE

- RF2435-12B 4 X M8
- RF2435-16B 4 X M10
- RF2435-20B 6 X M12



FOLDING

- RF2436-06 3 X M6
- RF2436-08 3 X M8
- RF2436-10 3 X M10

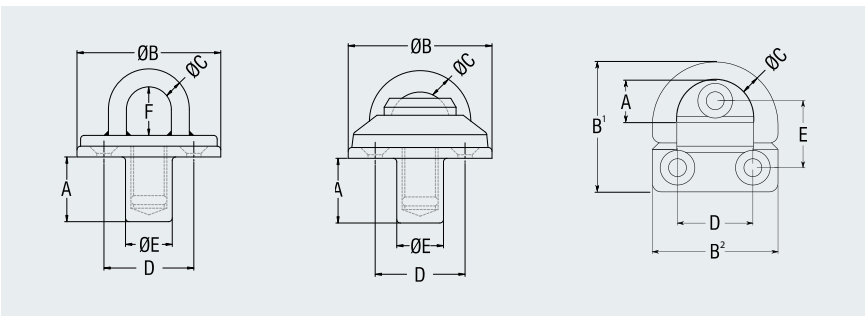

- ✔ Screw in, removable padeyes allow the block and padeye to be easily removed when not in use.
- ✔ Integral threaded plug in removable padeyes prevents grit from entering the threaded socket when the padeye is removed.
- ✔ Folding padeyes provide a low profile solution with the eye pivoting upright when required for use.
- ✔ Removable screw-in padeyes are ideal for attaching blocks which may be removed when not in use or while cruising. A threaded plug remains in the base section when the top plate is removed to prevent dirt and grit from entering the threads.
- ✔ Hand-polished finish.
- ✔ Grade 316 stainless steel.

PRODUCT No.	DESCRIPTION	A mm	B mm	C mm	D mm	E mm	F mm	M.W.L. kg	B.L.* ³ kg	WEIGHT g	A in	B in	C in	D in	E in	F in	M.W.L. lb	B.L.* ³ lb	WEIGHT oz
Padeyes																			
RF2435-12B	Removable, non-tumble	36	80	12.0	50.0	26	-	4000	8000	560	1 7/16	3 5/32	15/32	1 31/32	1 1/32	-	8800	17600	19.8
RF2433-09	Removable	30	55	9.0	38.0	14	23	2000	4000	285	1 3/16	2 5/32	11/32	1 1/2	9/16	29/32	4410	8820	10.1
RF2433-10	Removable	32	72	10.0	99.5	19	30	2500	5000	550	1 1/4	2 27/32	13/32	1 15/16	3/4	1 3/16	5510	11020	19.4
RF2435-14	Removable	40	100	14.0	70.0	32	32	7500	15000	1100	1 9/16	3 15/16	9/16	2 3/4	1 1/4	1 1/4	16530	33070	38.8
RF2435-16B	Removable, non-tumble	40	100	16.0	70.0	-	-	8000	16000	2200	1 9/16	3 15/16	5/8	2 3/4	1 1/4	-	17640	35270	77.6
RF2435-20B	Removable, non-tumble	52	135	19.8	74.5	-	-	13500	27000	3700	2 1/16	5 5/16	25/32	2 15/16	-	-	29760	59520	130.4
RF2436-06	Folding	13.5* ¹	46.5 x 45* ²	7.7	27.0	24	-	1100	2200	74	1/2* ¹	1 7/8 x 1 13/16* ²	5/16	1 1/16	-	-	2420	4840	2.6
RF2436-08	Folding	18.5* ¹	61 x 59* ²	10.4	35.0	29.5	-	2000	4000	172	1 1/16* ¹	2 7/16 x 2 3/8* ²	7/16	1 3/8	1 5/32	-	4400	8800	6.1
RF2436-10	Folding	23.5* ¹	77 x 75* ²	13.2	45.0	39	-	3650	7300	356	7/8* ¹	3 1/16 x 3* ²	9/16	1 3/4	1 17/32	-	8030	16060	12.6

*1 Eye clearance when upright.

*2 B' x B²

*3 A4-80 DIN7991 grade fasteners recommended to achieve BL

EYE BOLTS & U-BOLTS



RING BOLTS



EYE BOLTS



U-BOLTS - STEPPED



RF5270
RF5271
RF5272



RF5280



RF5290
RF5292-M6
RF5292-M8

ANCHOR BOLTS

- ✔ Eye bolts and ring bolts are supplied with washers and a nut.
- ✔ U-bolts are supplied with a top plate, backing plate and nuts.
- ✔ RF5280 is supplied with a washer and nut.
- ✔ Grade 316 stainless steel.

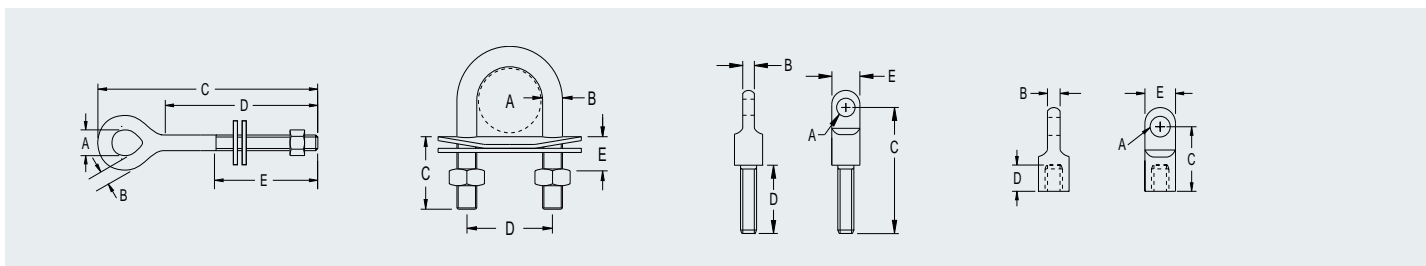

PRODUCT No.	THREAD TYPE	A mm	B mm	C mm	D mm	E mm	WEIGHT g	A in	B in	C in	D in	E in	WEIGHT oz
-------------	-------------	------	------	------	------	------	----------	------	------	------	------	------	-----------

Ring Bolts													
RF26	1/4 UNC	25	5.0	63	25	20	35	1	3/16	2 1/2	1	3/4	1.2
RF424	1/4 UNC	25	5.0	90	51	22	40	1	3/16	3 1/2	2	7/8	1.4

Eye Bolts													
RF156	3/16 UNC	10	4.0	76	51	38	10	13/32	5/32	3	2	1 1/2	0.4
RF157	3/16 UNC	10	4.0	100	75	51	15	13/32	5/32	4	3	2	0.5
RF159	1/4 UNC	12	5.5	81	51	38	25	15/32	7/32	3 3/16	2	1 1/2	0.9
RF160	1/4 UNC	12	5.5	108	76	51	30	15/32	7/32	4 1/4	3	2	1.1
RF161	1/4 UNC	12	5.5	132	102	51	35	15/32	7/32	5 3/16	4	2	1.2
RF162	1/4 UNC	12	5.5	160	127	51	40	15/32	7/32	6 5/16	5	2	1.4
RF163	1/4 UNC	12	5.5	180	152	51	50	15/32	7/32	7	6	2	1.8
RF164	5/16 UNC	13	7.0	111	76	51	60	1/2	9/32	4 3/8	3	2	2.1
RF165	5/16 UNC	13	7.0	139	102	51	65	1/2	9/32	5 1/3	4	2	2.3
RF166	5/16 UNC	13	7.0	162	127	51	75	1/2	9/32	6 3/8	5	2	2.7
RF167	5/16 UNC	13	7.0	187	152	51	80	1/2	9/32	7 3/8	6	2	2.8
RF168	3/8 UNC	17	8.5	116	76	51	80	21/32	11/32	4 1/2	3	2	2.8
RF169	3/8 UNC	17	8.5	140	102	51	90	21/32	11/32	5 1/2	4	2	3.2
RF170	3/8 UNC	17	8.5	167	127	51	100	21/32	11/32	6 5/8	5	2	3.5
RF171	3/8 UNC	17	8.5	193	152	51	110	21/32	11/32	7 5/8	6	2	3.9

Anchor Bolts & Nuts													
RF5270	1/4 UNF	6.4	4.8	50.0	27	14.4	19	1/4	3/16	1 31/32	11/16	9/16	0.7
RF5271	1/4 UNF	6.4	4.8	77.0	54	14.4	27	1/4	3/16	3	2 1/8	9/16	1.0
RF5272	M6	6.1	4.8	22.5	9	14.4	18	1/4	3/16	7/8	11/32	9/16	0.7
RF5280	1/4 UNF	6.4	4.8	50.0	27	14.4	26	1/4	3/16	1 31/32	11/16	9/16	0.9
RF5290	1/4 UNF	6.4	4.8	22.5	8	14.4	12	1/4	3/16	7/8	5/16	9/16	0.4
RF5292-M6	M6	6.4	4.8	22.5	8	14.4	12	1/4	3/16	7/8	5/16	9/16	0.4
RF5292-M8	M8	6.4	4.8	22.5	8	14.4	12	1/4	3/16	7/8	5/16	9/16	0.4

U-Bolts - Stepped													
RF559	1/4 UNC	24	8.0	38	25.5	6	70	15/16	5/16	1 1/2	3/4	1/4	2.5
RF543	5/16 UNC	28	9.5	25	33.5	4	95	1 1/8	3/8	1	1	5/32	3.4
RF541	5/16 UNC	28	9.5	38	33.5	8	105	1 1/8	3/8	1 1/2	1	5/16	3.7
RF544	5/16 UNC	28	9.5	51	33.5	6	110	1 1/8	3/8	2	1	1/4	3.9
RF547	5/16 UNC	28	9.5	77	33.5	32	130	1 1/8	3/8	3	1	1 1/4	4.6
RF548	5/16 UNC	28	9.5	103	33.5	58	150	1 1/8	3/8	4	1	2 9/32	5.3
RF549	5/16 UNC	28	9.5	127	33.5	71	170	1 1/8	3/8	5	1	2 13/16	6.0

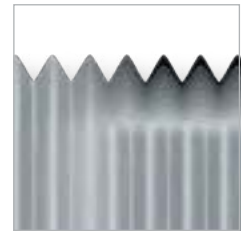

Rolled threads for maximum strength



Roll swage integrity

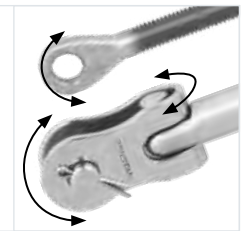

Versatile end connection options



Calibrated models

TYPE 10 TURNBUCKLES

ELEGANT DESIGN, EXCEPTIONAL PERFORMANCE

From their clean lines to the use of the highest grade materials and quality finish, Ronstan Type 10 turnbuckles are engineered to deliver performance while enhancing the appearance of any yacht, or tensile project.

Type 10

Type 10 closed body turnbuckles have a sleek, modern profile with no sharp edges. They are easily adjusted by turning the unique adjustment nut, which is free to rotate within the sleeve on the turnbuckle body, and are secured with a quick turn on the locking nut. A sight hole is provided in the body to verify adequate thread engagement. With fine thread and single end adjustment, Type 10 turnbuckles are much easier to adjust than conventional turnbuckles, and the use of dissimilar but compatible metals for the threaded components avoids the risk of thread seizure. Toggles are designed with full lateral articulation for easy installation and connection compatibility.

Fine, rolled threads

Ronstan rigging fittings have rolled threads for maximum strength and reliability – unlike cut threads, the stainless steel bar is formed up and down to create a thread with the grain remaining unbroken and flowing the full length of the thread. Threads are UNF (Unified National Fine), short pitch threads for fine adjustment and reduced adjustment effort.

Roll swage integrity

Swage fittings suit industry-standard roll swaging presses and dimensions are derived from the original 'Milspec' for maximum integrity. They are suitable for use with modern and traditional wire constructions, including 1x19, 7x19 and compact strand.

Termination options

A full range of eye, fork and toggle fittings complement the turnbuckles to permit assembly of finished rigging elements to suit virtually any application.

Calibrated turnbuckles

For accurate, repeatable settings of rig tension and precise adjustment, calibrated turnbuckle models are available for wire sizes up to 8mm (5/16"); thread sizes 1/4", 5/16", 3/8", 1/2" UNF.

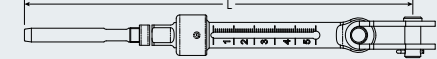
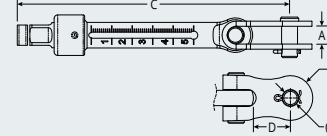
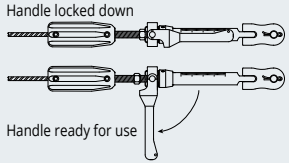

METRIC DIMENSIONS

WIRE DIAM.	TYPICAL GRADE 1570 1x19 WIRE B.L. kg	THREADED SWAGE TERMINAL PRODUCT No.	THREADED SWAGE TERMINAL B.L. kg	THREAD SIZE	A mm	B mm	C mm	D mm	WEIGHT g
Calibrated Turnbuckles - Metric Wire									
3mm	760	RF1512M0304	1350	1/4" UNF	4.9	39.2	133	74	24
4mm	1350	RF1512M0404	1480		6.0	45.5	141	74	30
4mm	1350	RF1512M0405	1780	5/16" UNF	6.0	45.5	153	89	44
5mm	2120	RF1512M0505	2360		7.5	55.5	164	89	52
5mm	2120	RF1512M0506	2550	3/8" UNF	7.5	55.5	179	105	76
6mm	3020	RF1512M0606	3580		10.5	70.4	195	105	115
6mm	3020	RF1512M0608	5410	1/2" UNF	10.5	70.4	245	143	196
7mm	4120	RF1512M0708	5410		12.2	79	250	143	222
8mm	5380	RF1512M0808	5410		14.0	88.5	263	143	258

TOGGLE END TURNBUCKLE BODY & LOCK NUT PRODUCT No.	TURNBUCKLE B.L. kg	THREAD SIZE	A mm	B mm	C mm	D mm	E mm	WEIGHT g	L MIN. mm	L MAX.* mm
RF1481-04	1480	1/4" UNF	7.8	9.1	115	16.3	6.2	75	174	229
									182	237
RF1481-05	2360	5/16" UNF	9.4	11.2	138	20.7	7.9	144	202	267
									213	278
RF1481-06	3580	3/8" UNF	10.5	14.4	162	23.2	9.4	245	237	317
									253	333
RF1481-08	5410	1/2" UNF	13.9	17.5	213	29.1	12.4	506	312	422
									320	430
									333	443

PRODUCT No.	DESCRIPTION	WEIGHT g	WEIGHT oz
Handles			
RF1473-05	Handle kit, suits 5/16" threaded turnbuckle body combinations. Features 87mm (3 7/16") long handle for maximum tensioning leverage, and lift and re-position operation for ease of use or when rotation space is restricted. Handle snaps into snag-free locked position. Includes black plastic grip.	75	2.6
RF1473-05H	Black plastic upper grip for 5/16" threaded swage terminals	50	1.8

*The sight hole relates to a length (L) slightly less than L MAX. If maximum length (L) is required the threaded end can be unscrewed beyond the sight hole, but the length must not exceed the specified L MAX dimension.

RF1473-05H GRIP



RF1473-05
HANDLE KIT



THREADED SWAGE
TERMINAL



TOGGLE END TURNBUCKLE BODY
& LOCK NUT

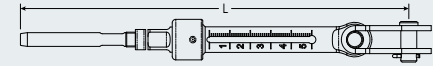
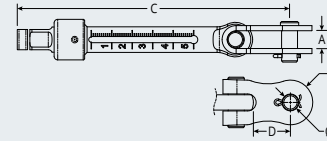
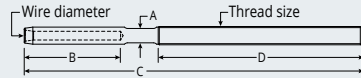
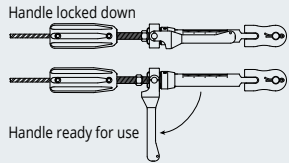

IMPERIAL DIMENSIONS

WIRE DIAM.	TYPICAL GRADE 1570 1x19 WIRE B.L. lb	THREADED SWAGE TERMINAL PRODUCT No.	THREADED SWAGE TERMINAL B.L. lb	THREAD SIZE	A in	B in	C in	D in	WEIGHT oz
Calibrated Turnbuckles - Metric Wire									
3mm	1670	RF1512M0304	2970	1/4" UNF	3/16	1 9/16	5 1/4	2 15/16	0.8
4mm	2970	RF1512M0404	3250		1/4	1 3/8	5 1/2	2 15/16	1.1
4mm	2970	RF1512M0405	3910	5/16" UNF	1/4	1 3/8	6	3 1/2	1.6
5mm	4660	RF1512M0505	5190		9/32	2 3/16	6 1/2	3 1/2	1.8
5mm	4660	RF1512M0506	5610	3/8" UNF	9/32	2 3/16	7 1/16	4 1/8	2.7
6mm	6640	RF1512M0606	7870		7/16	2 3/4	7 11/16	4 1/8	4.1
6mm	6640	RF1512M0608	11900	1/2" UNF	7/16	2 3/4	9 5/8	5 5/8	196
7mm	9060	RF1512M0708	11900		1/2	3 1/8	9 7/8	5 5/8	222
8mm	11840	RF1512M0808	11900	9/16	3 1/2	10 3/8	5 5/8	258	

TOGGLE END TURNBUCKLE BODY & LOCK NUT PRODUCT No.	TURNBUCKLE B.L. lb	THREAD SIZE	A in	B in	C in	D in	E in	WEIGHT oz	L MIN. in	L MAX.* in
RF1481-04	3250	1/4" UNF	9/32	3/8	4 9/16	5/8	1/4	2.7	6 13/16 5 1/8	9 9 3/8
RF1481-05	5190	5/16" UNF	11/32	15/32	5 5/16	13/16	5/16	5.1	7 15/16 8 3/8	10 9/16 11
RF1481-06	7870	3/8" UNF	13/32	19/32	6 3/8	29/32	3/8	8.6	9 5/16 9 15/16	12 1/2 13 1/8
RF1481-08	11900	1/2" UNF	17/32	11/16	8 3/8	1 1/8	1/2	17.8	12 1/4 12 9/16 13 1/8	16 5/8 16 15/16 17 7/16

* The sight hole relates to a length (L) slightly less than L MAX. If maximum length (L) is required the threaded end can be unscrewed beyond the sight hole, but the length must not exceed the specified L MAX dimension.



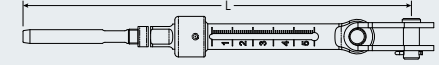
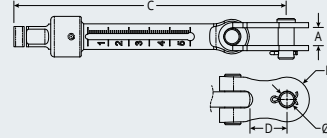
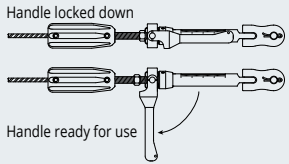

METRIC DIMENSIONS

WIRE DIAM.	TYPICAL GRADE 1570 1x19 WIRE B.L. kg	THREADED SWAGE TERMINAL PRODUCT No.	THREADED SWAGE TERMINAL B.L. kg	THREAD SIZE	A mm	B mm	C mm	D mm	WEIGHT g
Calibrated Turnbuckles - Imperial Wire									
1/8"	860	RF1510-0404	1300	1/4" UNF	4.9	39.2	133	74	22
5/32"	1350	RF1510-0504*1	1480		6.0	45.5	141	74	30
5/32"	1350	RF1510-0505*1	1780	5/16" UNF	6.0	45.5	153	89	44
3/16"	1930	RF1510-0605	2360		7.5	55.5	164	89	56
3/16"	1930	RF1510-0606	2620	3/8" UNF	7.5	55.5	179	105	78
7/32"	2630	RF1510-0706	3580		9.0	61.0	185	105	90
1/4"	3440	RF1510-0806	3580		9.0	70.4	195	105	110
1/4"	3450	RF1510-0808	5360	1/2" UNF	10.5	70.4	245	143	196
9/32"	4130	RF1510-0908*1	5410		12.2	79	253	143	222
5/16"	5380	RF1510-1008*1	5410		14.0	88.5	267	143	258

TOGGLE END TURNBUCKLE BODY & LOCK NUT PRODUCT No.	TURNBUCKLE B.L. kg	THREAD SIZE	A mm	B mm	C mm	D mm	E mm	WEIGHT g	L MIN. mm	L MAX.*2 mm
RF1481-04	1480	1/4" UNF	7.8	9.1	115	16.3	6.2	75	174	229
RF1481-05	2360	5/16" UNF	9.4	11.2	138	20.7	7.9	144	202	267
RF1481-06	3580	3/8" UNF	10.5	14.4	162	23.2	9.4	245	213	278
RF1481-08	5410	1/2" UNF	13.9	17.5	213	29.1	12.4	506	237	317
									242	322
									255	335
									312	422
									320	430
									333	443

PRODUCT No.	DESCRIPTION	WEIGHT g	WEIGHT oz
Handle Kit			
RF1473-05	Handle kit, suits 5/16" threaded turnbuckle body combinations. Features 87mm (3 7/16") long handle for maximum tensioning leverage, and lift and re-position operation for ease of use or when rotation space is restricted. Handle snaps into snag-free locked position. Includes black plastic grip.	75	2.6
RF1473-05H	Black plastic upper grip for 5/16" threaded swage terminals	50	1.8

*1 Product supplied as the metric equivalent with metric wire code stamping.

*2 The sight hole relates to a length (L) slightly less than L MAX. If maximum length (L) is required the threaded end can be unscrewed beyond the sight hole, but the length must not exceed the specified L MAX dimension.

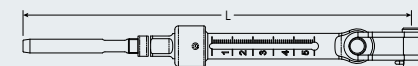
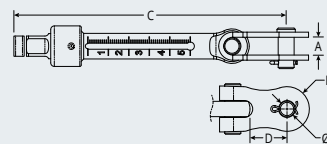
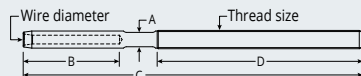
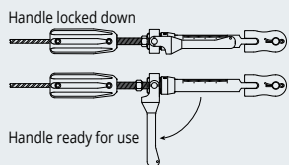

IMPERIAL DIMENSIONS

WIRE DIAM.	TYPICAL GRADE 1570 1x19 WIRE B.L. lb	THREADED SWAGE TERMINAL PRODUCT No.	THREADED SWAGE TERMINAL B.L. lb	THREAD SIZE	A in	B in	C in	D in	WEIGHT oz
Calibrated Turnbuckles - Imperial Wire									
1/8"	1890	RF1510-0404	2860	1/4" UNF	3/16	19/16	5 1/4	2 15/16	0.8
5/32"	2980	RF1510-0504*1	3250		1/4	13/8	5 1/2	2 15/16	1.1
5/32"	2980	RF1510-0505*1	3920	5/16" UNF	1/4	1 3/8	6	3 1/2	1.6
3/16"	4260	RF1510-0605	5190		9/32	2 3/16	6 1/2	3 1/2	2.0
3/16"	4260	RF1510-0606	5760	3/8" UNF	9/32	2 3/16	7 1/16	4 1/8	2.8
7/32"	5810	RF1510-0706	7870		3/8	2 3/8	7 5/16	4 1/8	3.2
1/4"	7580	RF1510-0806	7870		3/8	2 3/4	7 11/16	4 1/8	3.9
1/4"	7590	RF1510-0808	11792	1/2" UNF	7/16	2 3/4	9 5/8	5 5/8	6.9
9/32"	9090	RF1510-0908*1	11900		1/2	3 1/8	9 15/16	5 5/8	7.8
5/16"	11840	RF1510-1008*1	11900		9/16	3 1/2	10 1/2	5 5/8	9.1

TOGGLE END TURNBUCKLE BODY & LOCK NUT PRODUCT No.	TURNBUCKLE B.L. lb	THREAD SIZE	A in	B in	C in	D in	E in	WEIGHT oz	L MIN. in	L MAX.*2 in
RF1481-04	3250	1/4" UNF	9/32	3/8	49/16	21/32	1/4	2.7	6 13/16 5 1/8	9 9 3/8
RF1481-05	5190	5/16" UNF	11/16	15/32	57/16	13/16	5/16	5.1	7 15/16 8 3/8	10 9/16 11
RF1481-06	7870	3/8" UNF	13/32	19/32	63/8	29/32	3/8	8.6	9 5/16 9 9/16 10 1/16	12 1/2 12 11/16 13 3/16
RF1481-08	11900	1/2" UNF	17/32	11/16	83/8	1 1/8	1/2	17.8	12 1/4 12 9/16 13 1/8	16 5/8 16 15/16 17 7/16

*1 Product supplied as the metric equivalent with metric wire code stamping.

*2 The sight hole relates to a length (L) slightly less than L MAX. If maximum length (L) is required the threaded end can be unscrewed beyond the sight hole, but the length must not exceed the specified L MAX dimension.



THREADED SWAGE
TERMINAL



TOGGLE END TURNBUCKLE BODY
& LOCK NUT

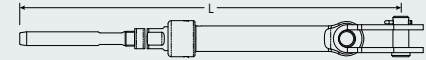
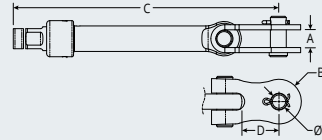
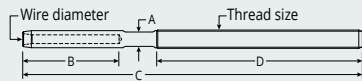

METRIC DIMENSIONS

WIRE DIAM.	TYPICAL GRADE 1570 1x19 WIRE B.L. kg	THREADED SWAGE TERMINAL PRODUCT No.	THREADED SWAGE TERMINAL B.L. kg	THREAD SIZE	A mm	B mm	C mm	D mm	WEIGHT g
Swage/Toggle Turnbuckles - Metric Wire									
3mm	760	RF1512M0304	1350	1/4" UNF	4.9	39.2	133	74	24
4mm	1350	RF1512M0404	1480		6.0	45.5	141	74	30
5mm	2120	RF1512M0504*1	1480		7.5	32.0	129	74	30
4mm	1350	RF1512M0405	1780	5/16" UNF	6.0	45.5	153	89	44
5mm	2120	RF1512M0505	2360		7.5	55.5	164	89	52
5mm	2120	RF1512M0506	2550	3/8" UNF	7.5	55.5	179	105	76
6mm	3020	RF1512M0606	3580		10.5	70.4	195	105	115
6mm	3020	RF1512M0608	5410	1/2" UNF	10.5	70.4	245	143	196
7mm	4120	RF1512M0708	5410		12.2	79.0	250	143	222
8mm	5380	RF1512M0808	5410		14.0	88.5	263	143	258
8mm	5380	RF1512M0810	7600	5/8" UNF	14.0	88.5	310	190	420
10mm	8420	RF1512M1010	8390		15.8	110.5	330	190	446
11mm	10570	RF1512M1112	10400	3/4" UNF	12.2	122.7	368	205	723
12mm	12130	RF1512M1212	12140		12.2	140.4	386	205	755
14mm	16510	RF1512M1414	16520	7/8" UNF	14.4	157.9	436	234	1150
16mm	21500	RF1512M1616	22450	1" UNF	18.0	176.7	473	240	1610

*1 Threaded swage terminal BL is below the typical BL of grade 1570 1x19 stainless steel wire.

*2 The sight hole relates to a length (L) slightly less than L MAX. If maximum length (L) is required the threaded end can be unscrewed beyond the sight hole, but the length must not exceed the specified L MAX dimension.

Note: Larger sizes available to order.

TOGGLE END TURNBUCKLE BODY & LOCK NUT PRODUCT No.	TURNBUCKLE B.L. kg	THREAD SIZE	A mm	B mm	C mm	D mm	E mm	WEIGHT g	L MIN. mm	L MAX.*2 mm
RF1480-04	1480	1/4" UNF	7.8	9.1	115	16.3	6.2	75	174	229
									182	237
									170	225
RF1480-05	2360	5/16" UNF	9.4	11.2	138	20.7	7.9	144	202	267
									213	278
RF1480-06	3580	3/8" UNF	10.5	14.4	162	23.2	9.4	245	237	317
									253	333
RF1480-08	5410	1/2" UNF	13.9	17.5	213	29.1	12.4	506	312	422
									320	430
									333	443
RF1480-10	8670	5/8" UNF	17.0	20.8	267	40.8	15.7	939	397	537
									417	557
RF1480-12	12630	3/4" UNF	20.0	23.8	314	47.2	18.9	1495	480	640
									498	658
RF1480-14	17230	7/8" UNF	26.6	28.5	348	44.4	22.0	2444	553	733
									617	797
RF1480-16	22450	1" UNF	29.3	31.8	379	63.3	25.2	3468		



THREADED SWAGE
TERMINAL



TOGGLE END TURNBUCKLE BODY
& LOCK NUT

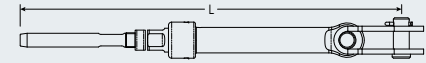
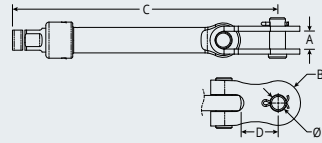

IMPERIAL DIMENSIONS

WIRE DIAM.	TYPICAL GRADE 1570 1x19 WIRE B.L. lb	THREADED SWAGE TERMINAL PRODUCT No.	THREADED SWAGE TERMINAL B.L. lb	THREAD SIZE	A in	B in	C in	D in	WEIGHT oz
Swage/Toggle Turnbuckles - Metric Wire									
3mm	1670	RF1512M0304	2970	1/4" UNF	3/16	1 9/16	5 1/4	2 15/16	0.9
4mm	2970	RF1512M0404	3250		1/4	1 3/8	5 1/2	2 15/16	1.1
5mm	4660	RF1512M0504*1	3250		9/32	1 1/4	5 1/16	2 15/16	1.1
4mm	2970	RF1512M0405	3910	5/16" UNF	1/4	1 3/8	6	3 1/2	1.6
5mm	4660	RF1512M0505	5190		9/32	2 3/16	6 1/2	3 1/2	1.8
5mm	4660	RF1512M0506	5610	3/8" UNF	9/32	2 3/16	7 1/16	4 1/8	2.9
6mm	6640	RF1512M0606	7870		7/16	2 3/4	7 11/16	4 1/8	4.1
6mm	6640	RF1512M0608	11900	1/2" UNF	7/16	2 3/4	9 5/8	5 5/8	6.8
7mm	9060	RF1512M0708	11900		1/2	3 1/8	9 7/8	5 5/8	7.8
8mm	11840	RF1512M0808	11900		9/16	3 1/2	10 3/8	5 5/8	8.5
8mm	11840	RF1512M0810	16720	5/8" UNF	9/16	3 1/2	12 3/8	7 1/2	14.8
10mm	18520	RF1512M1010	18450		5/8	4 3/8	13	7 1/2	15.7
11mm	23250	RF1512M1112	22880	3/4" UNF	1/2	4 13/16	14 1/2	8 1/16	25.5
12mm	26690	RF1512M1212	26700		1/2	5 1/2	15 3/16	8 1/16	26.6
14mm	36320	RF1512M1414	36340	7/8" UNF	9/16	6 1/4	17 3/16	9 1/4	40.6
16mm	47300	RF1512M1616	49390	1" UNF	3/4	6 15/16	18 5/8	9 7/16	56.8

TOGGLE END TURNBUCKLE BODY & LOCK NUT PRODUCT No.	TURNBUCKLE B.L. lb	THREAD SIZE	A in	B in	C in	D in	E in	WEIGHT oz	L MIN. in	L MAX.*2 in
RF1480-04	3250	1/4" UNF	9/32	3/8	4 9/16	5/8	1/4	2.7	6 13/16	9
									5 1/8	9 3/8
RF1480-05	5190	5/16" UNF	11/32	15/32	5 7/16	25/32	5/16	5.1	7 15/16	10 9/16
									8 3/8	11
RF1480-06	7870	3/8" UNF	13/32	19/32	6 3/8	29/32	3/8	8.6	9 5/16	12 1/2
									9 15/16	13 1/8
RF1480-08	11900	1/2" UNF	17/32	11/16	8 3/8	1 1/8	1/2	17.8	12 5/16	16 5/8
									12 9/16	16 15/16
RF1480-10	19070	5/8" UNF	21/32	27/32	10 7/8	1 5/8	5/8	33.1	15 5/8	21 3/16
									16 7/16	21 15/16
RF1480-12	27780	3/4" UNF	25/32	15/16	12 3/8	1 7/8	3/4	52.7	18 15/16	25 3/16
									19 5/8	25 15/16
RF1480-14	37900	7/8" UNF	1 1/32	1 1/8	13 11/16	1 3/4	7/8	86.2	21 3/4	28 7/8
RF1480-16	49390	1" UNF	1 1/8	1 1/4	14 15/16	2 1/2	1	122.3	24 5/16	31 3/8

*1 Threaded swage terminal BL is below the typical B.L. of grade 1570 1x19 stainless steel wire.

*2 The sight hole relates to a length (L) slightly less than L MAX. If maximum length (L) is required the threaded end can be unscrewed beyond the sight hole, but the length must not exceed the specified L MAX dimension.

Note: Larger sizes available to order.



THREADED SWAGE
TERMINAL



TOGGLE END TURNBUCKLE BODY
& LOCK NUT

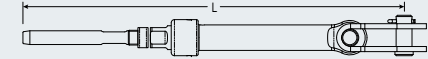
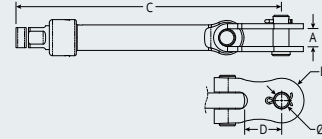
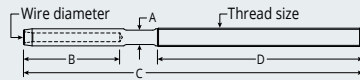

METRIC DIMENSIONS

WIRE DIAM.	TYPICAL GRADE 1570 1x19 WIRE B.L. kg	THREADED SWAGE TERMINAL PRODUCT No.	THREADED SWAGE TERMINAL B.L. kg	THREAD SIZE	A mm	B mm	C mm	D mm	WEIGHT g
Swage/Toggle Turnbuckles - Imperial Wire									
1/8"	860	RF1510-0404	1300	1/4" UNF	4.9	39.2	133	74	22
5/32"	1360	RF1510-0504*2	1480		6.0	45.5	141	74	30
3/16"	1940	RF1510-0604*1	1480		7.5	32.0	129	74	32
5/32"	1360	RF1510-0505*2	1780	5/16" UNF	6.0	45.5	153	89	44
3/16"	1940	RF1510-0605	2360		7.5	55.5	164	89	56
3/16"	1940	RF1510-0606	2620	3/8" UNF	7.5	55.5	179	105	78
7/32"	2640	RF1510-0706	3580		9.0	61.0	185	105	90
1/4"	3450	RF1510-0806	3580		9.0	70.4	195	105	110
1/4"	3450	RF1510-0808	5360	1/2" UNF	10.5	70.4	245	143	196
9/32"	4130	RF1510-0908*2	5410		12.2	79.0	253	143	222
5/16"	5380	RF1510-1008*2	5410		14.0	88.5	267	143	258
5/16"	5380	RF1510-1010*2	7600	5/8" UNF	14.0	88.5	310	190	420
3/8"	7590	RF1510-1210	8670		15.8	110.5	328	190	452
7/16"	10570	RF1510-1412*2	10400	3/4" UNF	12.2	122.7	368	205	723
1/2"	13560	RF1510-1614*1	11360	7/8" UNF	14.4	140.4	410	234	1025
9/16"	16510	RF1510-1814*2	16520		14.4	157.9	436	234	1150
5/8"	21510	RF1510-2016*2	22450	1" UNF	18.0	176.7	473	240	1610

TOGGLE END TURNBUCKLE BODY & LOCK NUT PRODUCT No.	TURNBUCKLE B.L. kg	THREAD SIZE	A mm	B mm	C mm	D mm	E mm	WEIGHT g	L MIN. mm	L MAX.*3 mm
RF1480-04	1480	1/4" UNF	7.8	9.1	115	16.3	6.2	75	174	229
									182	237
									170	225
RF1480-05	2360	5/16" UNF	9.4	11.2	138	20.7	7.9	144	202	267
									213	278
RF1480-06	3580	3/8" UNF	10.5	14.4	162	23.2	9.4	245	237	317
									242	322
									255	335
RF1480-08	5410	1/2" UNF	13.9	17.5	213	29.1	12.4	506	312	422
									320	430
									333	443
RF1480-10	8670	5/8" UNF	17.0	20.8	276	40.8	15.7	939	397	537
									417	557
RF1480-12	12630	3/4" UNF	20.0	23.8	314	47.2	18.9	1495	480	640
RF1480-14	17230	7/8" UNF	26.6	28.5	348	44.4	22.0	2444	523	703
									553	733
RF1480-16	22450	1" UNF	29.3	31.8	379	63.3	25.2	3468	617	797

*1 Threaded swage terminal B.L. is below the typical B.L. of grade 1570 1x19 stainless steel wire.

*2 Product supplied as the metric equivalent with metric wire code stamping.

*3 The sight hole relates to a length (L) slightly less than L MAX. If maximum length (L) is required the threaded end can be unscrewed beyond the sight hole, but the length must not exceed the specified L MAX dimension.

Note: Larger sizes available to order.



THREADED SWAGE
TERMINAL



TOGGLE END TURNBUCKLE BODY
& LOCK NUT

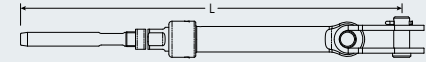
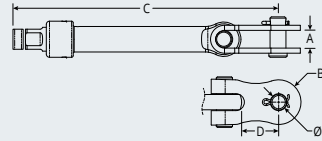
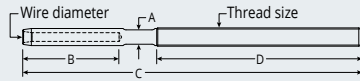

IMPERIAL DIMENSIONS

WIRE DIAM.	TYPICAL GRADE 1570 1x19 WIRE B.L. lb	THREADED SWAGE TERMINAL PRODUCT No.	THREADED SWAGE TERMINAL B.L. lb	THREAD SIZE	A in	B in	C in	D in	WEIGHT oz
Swage/Toggle Turnbuckles - Imperial Wire									
1/8"	1890	RF1510-0404	2860	1/4" UNF	3/16	1 9/16	5 1/4	2 15/16	0.8
5/32"	2980	RF1510-0504*2	3250		1/4	1 3/8	5 1/2	2 15/16	1.1
3/16"	4260	RF1510-0604*1	3250		9/32	1 1/4	5 1/16	2 15/16	1.1
5/32"	2980	RF1510-0505*2	3916	5/16" UNF	1/4	1 3/8	6	3 1/2	1.6
3/16"	4260	RF1510-0605	5190		9/32	2 3/16	6 1/2	3 1/2	2.0
3/16"	4260	RF1510-0606	5764	3/8" UNF	9/32	2 3/16	7 1/16	4 1/8	2.8
7/32"	5810	RF1510-0706	7870		3/8	2 3/8	7 5/16	4 1/8	3.2
1/4"	7590	RF1510-0806	7870		3/8	2 3/4	7 11/16	4 1/8	3.9
1/4"	7590	RF1510-0808	11792	1/2" UNF	7/16	2 3/4	9 5/8	5 5/8	6.9
9/32"	9090	RF1510-0908*2	11900		1/2	3 1/8	9 15/16	5 5/8	7.8
5/16"	11840	RF1510-1008*2	11900		9/16	3 1/2	10 1/2	5 5/8	9.1
5/16"	11840	RF1510-1010*2	16720	5/8" UNF	9/16	3 1/2	12 3/8	7 1/2	14.8
3/8"	16700	RF1510-1210	19070		5/8	4 3/8	12 15/16	7 1/2	15.9
7/16"	23250	RF1510-1412*2	22880	3/4" UNF	1/2	4 13/16	14 5/8	8 1/16	25.5
1/2"	29830	RF1510-1614*1	24992	7/8" UNF	9/16	5 1/2	16 5/32	9 1/4	36.2
9/16"	36320	RF1510-1814*2	36344		9/16	6 1/4	17 5/8	9 1/4	40.6
5/8"	47320	RF1510-2016*2	49390		1" UNF	3/4	6 15/16	19	9 7/16

TOGGLE END TURNBUCKLE BODY & LOCK NUT PRODUCT No.	TURNBUCKLE B.L. lb	THREAD SIZE	A in	B in	C in	D in	E in	WEIGHT oz	L MIN. in	L MAX.*3 in
RF1480-04	3250	1/4" UNF	9/32	3/8	4 9/16	5/8	1/4	2.7	6 13/16	9
									5 1/8	9 3/8
									6 11/16	8 7/8
RF1480-05	5190	5/16" UNF	3/8	15/32	5 7/16	25/32	5/16	5.1	7 15/16	10 9/16
									8 3/8	11
RF1480-06	7870	3/8" UNF	13/32	19/32	6 3/8	29/32	3/8	8.6	9 5/16	12 1/2
									9 1/2	12 11/16
									10 1/16	13 3/16
RF1480-08	11900	1/2" UNF	17/32	11/16	8 3/8	1 1/8	1/2	17.8	12 1/4	16 5/8
									12 9/16	16 15/16
									13 1/8	17 7/16
RF1480-10	19070	5/8" UNF	21/32	27/32	10 7/8	1 5/8	5/8	33.1	15 5/8	21 3/16
									16 7/16	21 15/16
RF1480-12	27780	3/4" UNF	25/32	15/16	12 3/8	1 7/8	3/4	52.7	18 15/16	25 3/16
RF1480-14	37900	7/8" UNF	1 1/32	1 1/8	13 11/16	1 3/4	7/8	86.2	20 5/8	27 11/16
									21 3/4	28 7/8
RF1480-16	49390	1" UNF	1 1/8	1 1/4	14 15/16	2 1/2	1	122.3	24 5/16	31 3/8

*1 Threaded swage terminal B.L. is below the typical B.L. of grade 1570 1x19 stainless steel wire.

*2 Product supplied as the metric equivalent with metric wire code stamping.

*3 The sight hole relates to a length (L) slightly less than L MAX. If maximum length (L) is required the threaded end can be unscrewed beyond the sight hole, but the length must not exceed the specified L MAX dimension.

Note: Larger sizes available to order.

**THREADED
TOGGLE**

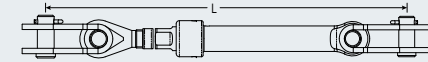
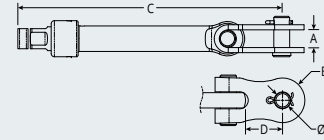
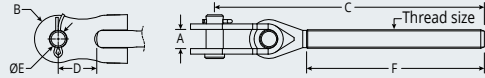
**TOGGLE END TURNBUCKLE BODY
& LOCK NUT**

METRIC DIMENSIONS

WIRE DIAM.	THREADED TOGGLE PRODUCT No.	THREADED TOGGLE B.L. kg	THREAD SIZE	A mm	B mm	C mm	D mm	E mm	F mm	WEIGHT g
Toggle/Toggle Turnbuckles										
3mm, 4mm, 5mm 1/8", 5/32", 3/16"	RF1504-0404	1480	1/4" UNF	7.8	9.1	112	15.5	6.2	74.6	46
4mm, 5mm 5/32", 3/16"	RF1504-0505	2360	5/16" UNF	9.4	11.2	131	20.0	7.9	89.0	88
5mm, 6mm 3/16", 7/32", 1/4"	RF1504-0606	3580	3/8" UNF	10.5	14.4	154	20.8	9.4	104.8	160
6mm, 7mm, 8mm 1/4", 9/32", 5/16"	RF1504-0808	5410	1/2" UNF	13.9	17.5	212	28.0	12.4	142.8	358

TOGGLE END TURNBUCKLE BODY & LOCK NUT PRODUCT No.	TURNBUCKLE B.L. kg	THREAD SIZE	A mm	B mm	C mm	D mm	E mm	WEIGHT g	L MIN. mm	L MAX.* mm
RF1480-04	1480	1/4" UNF	7.8	9.1	115	16.3	6.2	75	152	207
RF1480-05	2360	5/16" UNF	9.4	11.2	138	20.7	7.9	144	180	245
RF1480-06	3580	3/8" UNF	10.5	14.4	162	23.2	9.4	245	212	292
RF1480-08	5410	1/2" UNF	13.9	17.5	213	29.1	12.4	506	282	392

IMPERIAL DIMENSIONS

	lb	in	in	in	in	in	in	in	oz	
Toggle/Toggle Turnbuckles										
3mm, 4mm, 5mm 1/8", 5/32", 3/16"	RF1504-0404	3250	1/4" UNF	9/32	3/8	4 3/8	5/8	1/4	2 15/16	1.6
4mm, 5mm 5/32", 3/16"	RF1504-0505	5190	5/16" UNF	3/8	7/16	5 3/16	13/16	5/16	3 1/2	3.1
5mm, 6mm 3/16", 7/32", 1/4"	RF1504-0606	7870	3/8" UNF	13/32	9/16	6 1/16	29/32	3/8	4 1/8	5.6
6mm, 7mm, 8mm 1/4", 9/32", 5/16"	RF1504-0808	11900	1/2" UNF	9/16	11/16	8 3/8	1 1/8	1/2	5 5/8	12.6

	lb	in	in	in	in	in	in	oz	in	in
RF1480-04	3250	1/4" UNF	9/32	3/8	4 9/16	5/8	1/4	2.7	6	8 1/8
RF1480-05	5190	5/16" UNF	11/32	15/32	5 7/8	25/32	5/16	5.1	7 1/16	9 5/8
RF1480-06	7870	3/8" UNF	13/32	19/32	6 3/8	29/32	3/8	8.6	8 3/8	11 1/2
RF1480-08	11900	1/2" UNF	17/32	11/16	8 3/8	1 1/8	1/2	17.8	11 1/8	15 7/16

* The sight hole relates to a length (L) slightly less than L MAX. If maximum length (L) is required the threaded end can be unscrewed beyond the sight hole, but the length must not exceed the specified L MAX dimension.
 Note: Larger sizes available to order.



THREADED EYE



TOGGLE END TURNBUCKLE BODY & LOCK NUT

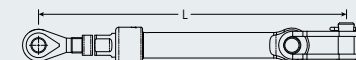
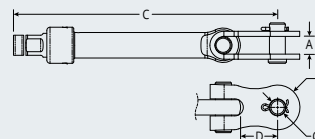
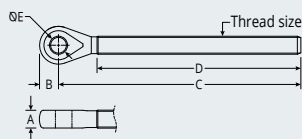

METRIC DIMENSIONS

WIRE DIAM.	THREADED EYE PRODUCT No.	THREADED EYE		A mm	B mm	C mm	D mm	E mm	WEIGHT g
		B.L. kg	THREAD SIZE						
3mm, 4mm, 5mm 1/8", 5/32", 3/16"	RF1502-0404	1480	1/4" UNF	4.6	5.7	88	75	6.5	19
4mm, 5mm 5/32", 3/16"	RF1502-0505	2360	5/16" UNF	6.1	9.0	102	87	8.1	37
5mm, 6mm 3/16", 7/32", 1/4"	RF1502-0606	3580	3/8" UNF	7.7	10.5	126	105	9.7	73

TOGGLE END TURNBUCKLE BODY & LOCK NUT PRODUCT No.	TURNBUCKLE B.L. kg	THREAD SIZE	A mm	B mm	C mm	D mm	E mm	WEIGHT g	L MIN. mm	L MAX.* mm
RF1480-05	2360	5/16" UNF	9.4	11.2	138	20.7	7.9	144	150	215
RF1480-06	3580	3/8" UNF	10.5	14.4	162	23.2	9.4	245	178	258

IMPERIAL DIMENSIONS

WIRE DIAM.	THREADED EYE PRODUCT No.	B.L. lb	THREAD SIZE	A in	B in	C in	D in	E in	WEIGHT oz
4mm, 5mm 5/32", 3/16"	RF1502-0505	5190	5/16" UNF	1/4	11/32	4	3 7/16	5/16	1.3
5mm, 6mm 3/16", 7/32", 1/4"	RF1502-0606	7870	3/8" UNF	5/16	13/32	4 15/16	4 1/8	3/8	2.6

TOGGLE END TURNBUCKLE BODY & LOCK NUT PRODUCT No.	TURNBUCKLE B.L. lb	THREAD SIZE	A in	B in	C in	D in	E in	WEIGHT oz	L MIN. in	L MAX.* in
RF1480-05	5190	5/16" UNF	11/32	15/32	5 7/8	25/32	5/16	5.1	5 15/16	8 1/2
RF1480-06	7870	3/8" UNF	13/32	19/32	6 3/8	29/32	3/8	8.6	7	10 3/16

* The sight hole relates to a length (L) slightly less than L MAX. If maximum length (L) is required the threaded end can be unscrewed beyond the sight hole, but the length must not exceed the specified L MAX dimension.

**THREADED
EYE**

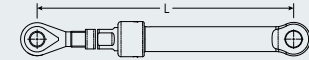
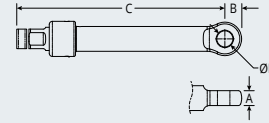
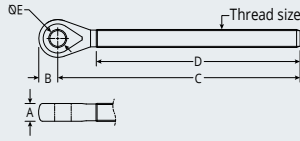
**EYE END TURNBUCKLE BODY
& LOCK NUT**

METRIC DIMENSIONS

WIRE DIAM.	THREADED EYE PRODUCT No.	THREADED EYE B.L. kg	THREAD SIZE	A mm	B mm	C mm	D mm	E mm	WEIGHT g
Eye/Eye Turnbuckles									
3mm, 4mm, 5mm 1/8", 5/32", 3/16"	RF1502-0404	1480	1/4" UNF	4.6	5.7	88	75	6.5	19
4mm, 5mm 5/32", 3/16"	RF1502-0505	2360	5/16" UNF	6.1	9.0	102	87	8.1	37
5mm, 6mm 3/16", 7/32", 1/4"	RF1502-0606	3580	3/8" UNF	7.7	10.5	126	105	9.7	73

EYE END TURNBUCKLE BODY & LOCK NUT PRODUCT No.	TURNBUCKLE B.L. kg	THREAD SIZE	A mm	B mm	C mm	D mm	E mm	WEIGHT g	L MIN. mm	L MAX.* mm
RF1484-04	1480	1/4" UNF	4.6	7.0	92	-	6.5	48	107	162
RF1484-05	2360	5/16" UNF	6.1	8.8	109	-	8.1	93	121	186
RF1484-06	3580	3/8" UNF	7.7	9.8	129	-	9.7	153	145	225

IMPERIAL DIMENSIONS

	lb	in	in	in	in	in	in	oz
Eye/Eye Turnbuckles								
3mm, 4mm, 5mm 1/8", 5/32", 3/16"	RF1502-0404	3250	1/4"	7/32"	3 1/2"	2 15/16"	1/4"	0.7
4mm, 5mm 5/32", 3/16"	RF1502-0505	5190	5/16"	11/32"	4"	3 7/16"	5/16"	1.3
5mm, 6mm 3/16", 7/32", 1/4"	RF1502-0606	7870	3/8"	13/32"	4 15/16"	4 1/8"	3/8"	2.6

	lb	in	in	in	in	in	oz	in	in
RF1484-04	3250	1/4"	9/32"	3 5/8"	-	1/4"	1.7	43/16"	63/8"
RF1484-05	5190	5/16"	11/32"	4 5/16"	-	5/16"	3.3	4 3/4"	7 5/16"
RF1484-06	7870	3/8"	5/16"	5 1/8"	-	3/8"	5.4	5 11/16"	8 7/8"

* The sight hole relates to a length (L) slightly less than L MAX. If maximum length (L) is required the threaded end can be unscrewed beyond the sight hole, but the length must not exceed the specified L MAX dimension.



THREADED SWAGE
TERMINAL

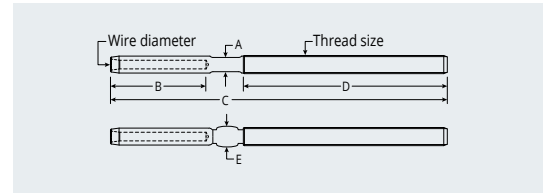

THREADED SWAGE TERMINAL PRODUCT No.	WIRE DIAM.	THREAD SIZE	SUITS TYPE 10 TURNBUCKLE BODY	A mm	B mm	C mm	D mm	E mm	WEIGHT g	A in	B in	C in	D in	E in	WEIGHT oz
Threaded Swage Terminals - Metric Wire															
METRIC DIMENSIONS															
IMPERIAL DIMENSIONS															
RF1512M0304	3mm	1/4" UNF	RF1480-04 RF1481-04	4.9	39.2	133	74	6.4	24	7/32	19/16	51/4	215/16	1/4	0.9
RF1512M0404	4mm			6.0	45.5	141	74	7.5	30	1/4	13/8	51/2	215/16	5/16	1.1
RF1512M0504*1	5mm			7.5	32.0	129	74	9.1	30	5/16	23/16	51/16	215/16	3/8	1.1
RF1512M0405	4mm	5/16" UNF	RF1480-05 RF1481-05	6.0	45.5	153	89	7.5	44	1/4	13/8	6	31/2	5/16	1.6
RF1512M0505	5mm			7.5	55.5	164	89	9.1	52	5/16	23/16	61/2	31/2	3/8	1.8
RF1512M0506	5mm	3/8" UNF	RF1480-06 RF1481-06	7.5	55.5	179	105	9.1	76	5/16	23/16	71/16	41/8	3/8	2.9
RF1512M0606	6mm			10.5	70.4	195	105	12.5	115	7/16	23/4	711/16	41/8	1/2	4.1
RF1512M0608	6mm	1/2" UNF	RF1480-08	10.5	70.4	245	143	12.5	194	7/16	23/4	95/8	55/8	1/2	6.8
RF1512M0708	7mm			12.2	79.0	250	143	14.3	222	1/2	31/8	97/8	55/8	9/16	7.8
RF1512M0808	8mm			14.0	88.5	263	143	16.1	258	9/16	31/2	103/8	55/8	21/32	8.5
RF1512M0810	8mm	5/8" UNF	RF1480-10	14.0	88.5	310	190	16.1	420	9/16	31/2	123/8	71/2	21/32	14.8
RF1512M1010	10mm			15.8	110.5	330	190	17.9	446	5/8	43/8	13	71/2	23/32	15.7
RF1512M1112	11mm	3/4" UNF	RF1480-12	12.2	122.7	368	205	20.7	723	1/2	413/16	141/2	81/16	13/16	25.5
RF1512M1212	12mm			12.2	140.4	386	205	21.4	755	1/2	51/2	153/16	81/16	27/32	26.6
RF1512M1414	14mm	7/8" UNF	RF1480-14	14.4	157.9	436	234	25.0	1150	9/16	61/4	173/16	91/4	1	40.6
RF1512M1616	16mm	1" UNF	RF1480-16	18.0	176.7	473	240	28.2	1610	3/4	615/16	185/8	97/16	11/8	56.8
Threaded Swage Terminals - Imperial Wire															
RF1510-0404	1/8"	1/4" UNF	RF1480-04 RF1481-04	4.9	39.2	133	74	6.4	22	7/32	19/16	51/4	215/16	1/4	0.8
RF1510-0504*2	5/32"			6.0	45.5	141	74	7.5	30	1/4	13/8	51/2	215/16	5/16	1.1
RF1510-0604*1	3/16"			7.5	32.0	129	74	9.1	32	5/16	11/4	51/16	215/16	3/8	1.1
RF1510-0505*2	5/32"	5/16" UNF	RF1480-05 RF1481-05	6.0	45.5	153	89	7.5	44	1/4	13/8	6	31/2	5/16	1.6
RF1510-0605	3/16"			7.5	55.5	164	89	9.1	56	5/16	23/16	61/2	31/2	3/8	2.0
RF1510-0606	3/16"	3/8" UNF	RF1480-06 RF1481-06	7.5	55.5	179	105	9.1	78	5/16	23/16	71/16	41/8	3/8	2.8
RF1510-0706	7/32"			9.0	61.0	185.0	105	10.8	90	3/8	23/8	75/16	41/8	7/16	3.2
RF1510-0806	1/4"			9.0	70.4	195.0	105	12.5	110	3/8	23/4	711/16	41/8	1/2	3.9
RF1510-0808	1/4"	1/2" UNF	RF1480-08	10.5	70.4	245	143	12.5	196	7/16	23/4	95/8	55/8	1/2	6.9
RF1510-0908*2	9/32"			12.2	79.0	253	143	14.3	222	1/2	31/8	915/16	55/8	9/16	7.8
RF1510-1008*2	5/16"			14.0	88.5	267	143	16.1	258	9/16	31/2	101/2	55/8	21/32	9.1
RF1510-1010*2	5/16"	5/8" UNF	RF1480-10	14.0	88.5	310	190	16.1	420	9/16	31/2	123/8	71/2	21/32	14.8
RF1510-1210	3/8"			15.8	110.5	328	190	17.9	452	5/8	43/8	1215/16	71/2	23/32	15.9
RF1510-1412*2	7/16"	3/4" UNF	RF1480-12	12.2	122.7	368	205	20.7	723	1/2	413/16	141/2	81/16	13/16	25.5
RF1510-1614*1	1/2"	7/8" UNF	RF1480-14	14.4	140.4	423	234	24.0	1025	9/16	51/2	165/8	91/4	31/32	36.2
RF1510-1814*2	9/16"			14.4	157.9	436	234	25.0	1150	9/16	61/4	173/16	91/4	1	40.6
RF1510-2016*2	5/8"	1" UNF	RF1480-16	18.0	176.7	473	240	28.2	1610	3/4	615/16	185/8	97/16	11/8	56.8

*1 Threaded swage terminal BL is below the typical BL of grade 1570 1x19 stainless steel wire.

*2 Product supplied as the metric equivalent with metric wire code stamping.

Note: Larger sizes available to order.



SHORT THREADED SWAGE TERMINAL

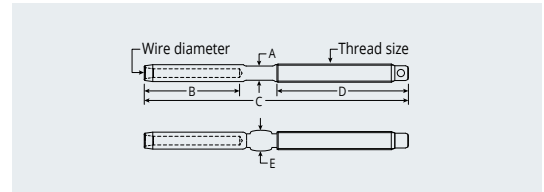

THREADED SWAGE TERMINAL PRODUCT No.	WIRE DIAM.	THREAD SIZE	SUITS OPEN BODY TURNBUCKLE*3	METRIC DIMENSIONS						IMPERIAL DIMENSIONS					
				A mm	B mm	C mm	D mm	E mm	WEIGHT g	A in	B in	C in	D in	E in	WEIGHT oz
RF1519M0304	3mm	1/4" UNF	RF1532M0304	4.9	39.2	109	56.0	6.4	21	3/16	1 9/16	4 5/16	2 3/16	1/4	0.7
RF1519M0404	4mm		RF1532M0404	6.0	45.5	123	56.0	7.5	25	1/4	1 3/8	4 13/16	2 3/16	5/16	0.9
RF1519M0504*1	5mm		RF1532M0504	7.5	55.5	134	56.0	9.1	35	9/32	2 3/16	5 1/4	2 3/16	3/8	1.2
RF1519M0405	4mm	5/16" UNF	RF1532M0405	6.0	45.5	123	60.0	7.5	40	1/4	1 3/8	4 7/8	2 3/8	5/16	1.4
RF1519M0505	5mm		RF1532M0505	7.5	55.5	135	60.0	9.1	44	9/32	2 3/16	5 5/16	2 3/8	3/8	1.6
RF1519M0506	5mm	3/8" UNF	RF1532M0506	7.5	55.5	144	70.0	9.1	60	9/32	2 3/16	5 5/8	2 3/4	3/8	2.1
RF1519M0606	6mm		RF1532M0606	10.5	70.4	160	70.0	12.5	92	7/16	2 3/4	6 5/16	2 3/4	1/2	3.3
RF1519M0608	6mm	1/2" UNF	RF1532M0608	10.5	70.4	177	80.0	12.5	141	7/16	2 3/4	7	3 1/8	1/2	5.0
RF1519M0708	7mm		RF1532M0708	12.2	79.0	193	80.0	14.3	172	1/2	3 1/8	7 5/8	3 1/8	9/16	6.1
RF1519M0808	8mm		RF1532M0808	14.0	88.5	200	80.0	16.1	202	9/16	3 1/2	7 7/8	3 1/8	21/32	7.1
RF1519M0810	8mm	5/8" UNF	RF1532M0810	14.0	88.5	219	98.0	16.1	290	9/16	3 1/2	8 5/8	3 7/8	21/32	10.2
RF1519M1010	10mm		RF1532M1010	15.8	110.5	238	98.0	17.9	313	5/8	4 3/8	9 3/8	3 7/8	23/32	11.1
RF1519M1112	11mm	3/4" UNF	RF1532M1112	12.2	122.7	280	125.0	20.7	500	1/2	4 13/16	11	4 15/16	13/16	17.7
RF1519M1212	12mm		RF1532M1212	12.2	140.4	306	125.0	20.7	597	1/2	5 1/2	12 1/16	4 15/16	13/16	21.1
RF1519M1414	14mm	7/8" UNF	RF1532M1414	14.4	157.9	346	144.0	25.0	916	9/16	6 3/16	13 5/8	5 11/16	1	32.4
RF1519M1616	16mm	1" UNF	RF1532M1616	18.0	176.7	388	158.0	28.0	1323	3/4	6 15/16	15 1/4	6 1/4	1 1/8	46.7
RF1518-0404	1/8"	1/4" UNF	RF1531-0404	4.9	39.2	109	56.0	6.4	21	3/16	1 9/16	4 5/16	2 3/16	1/4	0.7
RF1518-0504*2	5/32"		RF1531-0504	6.0	45.5	123	56.0	7.5	25	1/4	1 3/8	4 13/16	2 3/16	5/16	0.9
RF1518-0604*1	3/16"		RF1531-0604	7.5	55.5	134	56.0	9.1	35	9/32	2 3/16	5 1/4	2 3/16	3/8	1.2
RF1518-0505*2	5/32"	5/16" UNF	RF1531-0505	6.0	45.5	123	60.0	7.5	40	1/4	1 3/8	4 7/8	2 3/8	5/16	1.4
RF1518-0605	3/16"		RF1531-0605	7.5	55.5	135	60.0	9.1	44	9/32	2 3/16	5 5/16	2 3/8	3/8	1.6
RF1518-0606	3/16"	3/8" UNF	RF1531-0606	7.5	55.5	144	70.0	9.1	60	9/32	2 3/16	5 5/8	2 3/4	3/8	2.1
RF1518-0706	7/32"		RF1531-0706	9.0	61.0	150	70.0	10.8	70	3/8	2 3/8	5 7/8	2 3/4	7/16	2.5
RF1518-0806	1/4"		RF1531-0806	10.5	70.4	160	70.0	12.5	94	3/8	2 3/4	6 5/16	2 3/4	1/2	3.3
RF1518-0808	1/4"	1/2" UNF	RF1531-0808	10.5	70.4	177	80.0	12.5	139	7/16	2 3/4	7	3 1/8	1/2	4.9
RF1518-0908*2	9/32"		RF1531-0908	12.2	79.0	193	80.0	14.3	172	1/2	3 1/8	7 5/8	3 1/8	9/16	6.1
RF1518-1008*2	5/16"		RF1531-1008	14.0	88.5	200	80.0	16.1	202	9/16	3 1/2	7 7/8	3 1/8	21/32	7.1
RF1518-1010*2	5/16"	5/8" UNF	RF1531-1010	14.0	88.5	219	98.0	16.1	290	9/16	3 1/2	8 5/8	3 7/8	21/32	10.2
RF1518-1210	3/8"		RF1531-1210	15.8	110.5	238	98.0	17.9	323	5/8	4 3/8	9 3/8	3 7/8	23/32	11.4
RF1518-1412*2	7/16"	3/4" UNF	RF1531-1412	12.2	122.7	280	125.0	20.7	500	1/2	4 13/16	11	4 15/16	13/16	17.7
RF1518-1614*1	1/2"	7/8" UNF	RF1531-1614	14.4	140.4	331	144.0	24.0	758	9/16	5 1/2	13	5 11/16	31/32	26.8
RF1518-1814*2	9/16"		RF1531-1814	14.4	157.9	346	144.0	25.0	916	9/16	6 3/16	13 5/8	5 11/16	1	32.4
RF1518-2016*2	5/8"	1" UNF	RF1531-2016	18.0	176.7	388	158.0	27.4	1323	23/32	6 31/32	15 9/32	6 1/8	1 3/32	46.7

*1 Threaded swage terminal BL is below the typical BL of grade 1570 1x19 stainless steel wire.

*2 Product supplied as the metric equivalent with metric wire code stamping.

*3 'Open Body' turnbuckles discontinued in 2017.



**TOGGLE SWAGE
TERMINAL**

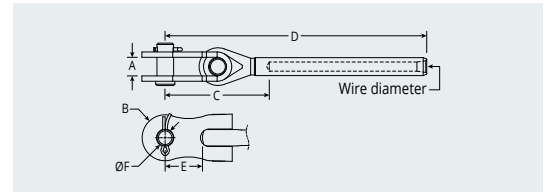

PRODUCT No.	WIRE DIAM.	A	B	C	D	E	F	WEIGHT	A	B	C	D	E	F	WEIGHT
		mm	mm	mm	mm	mm	mm	g	in	in	in	in	in	in	oz
Toggle Swage Terminals - Metric Wire															
RF1507M0304	3mm	7.8	9.1	37.9	77.0	16.8	6.2	44	5/16	11/32	1 1/2	3 1/32	21/32	1/4	1.6
RF1507M0404	4mm	7.8	9.1	43.2	87.1	16.8	6.2	44	5/16	11/32	1 11/16	3 7/16	21/32	1/4	1.6
RF1507M0405	4mm	9.4	11.2	48.1	93.6	20.7	7.9	74	3/8	7/16	1 29/32	3 11/16	13/16	5/16	2.6
RF1507M0504*1	5mm	7.8	9.1	38.4	94.8	16.8	6.2	72	5/16	11/32	1 1/2	3 23/32	21/32	1/4	2.5
RF1507M0505	5mm	9.4	11.2	48.2	103.7	20.7	7.9	56	3/8	7/16	1 29/32	4 3/32	13/16	5/16	2.0
RF1507M0506	5mm	10.0	14.4	49.4	104.9	23.0	9.4	130	13/32	9/16	1 15/16	4 1/8	29/32	3/8	4.6
RF1507M0606	6mm	10.0	14.4	58.1	128.5	23.0	9.4	129	13/32	9/16	2 9/32	5 1/16	29/32	3/8	4.6
RF1507M0608	6mm	13.9	17.5	70.9	141.3	29.4	12.4	285	9/16	11/16	2 25/32	5 9/16	1 5/32	1/2	10.1
RF1507M0708	7mm	13.9	17.5	73.2	151.9	29.4	12.4	332	17/32	11/16	2 7/8	5 31/32	1 5/32	1/2	11.7
RF1507M0808	8mm	13.9	17.5	72.1	160.6	29.4	12.4	365	9/16	11/16	2 27/32	6 3/8	1 5/32	1/2	12.9
RF1507M0810	8mm	17.0	20.8	87.5	176.0	42.2	15.7	492	21/32	13/16	3 7/16	6 15/16	1 21/32	5/8	17.4
RF1507M1010	10mm	17.0	20.8	87.7	198.2	42.2	15.7	540	21/32	13/16	3 7/16	7 13/16	1 21/32	5/8	19.1
RF1507M1112	11mm	20.0	23.8	101.9	224.4	48.9	18.9	838	3/4	15/16	4	8 27/32	1 15/16	3/4	29.6
RF1507M1212	12mm	20.0	23.8	108.2	249.0	46.0	18.9	930	25/32	15/16	4 1/4	9 13/16	1 13/16	3/4	32.8
RF1507M1414	14mm	26.5	28.5	120.4	278.3	44.4	22.0	1460	1 1/32	1 1/8	4 3/4	10 31/32	1 3/4	7/8	51.5
RF1507M1616	16mm	29.3	31.8	147.8	324.5	60.3	25.2	2350	1 5/32	1 1/4	5 13/16	12 25/32	2 3/8	1	82.9
Toggle Swage Terminals - Imperial Wire															
RF1506-0404	1/8"	7.8	9.1	37.9	77.0	16.8	6.2	44	5/16	11/32	1 1/2	3 1/16	21/32	1/4	1.6
RF1506-0504*2	5/32"	7.8	9.1	42.2	87.1	16.8	6.2	44	5/16	11/32	1 21/32	3 7/16	21/32	1/4	1.6
RF1506-0505*2	5/32"	9.4	11.2	48.1	93.6	20.7	7.9	70	3/8	7/16	1 29/32	3 11/16	13/16	5/16	2.5
RF1506-0604*1	3/16"	7.8	9.1	38.7	94.8	16.8	6.2	56	5/16	11/32	1 1/2	3 23/32	21/32	1/4	2.0
RF1506-0605	3/16"	9.4	11.2	42.5	98.0	20.7	7.9	78	3/8	7/16	1 11/16	3 27/32	13/16	5/16	2.8
RF1506-0606	3/16"	10.0	14.4	49.4	104.9	23.0	9.4	130	13/32	9/16	1 15/16	4 1/8	29/32	3/8	4.6
RF1506-0706	7/32"	10.0	14.4	49.9	110.9	23.0	9.4	142	13/32	9/16	1 31/32	4 3/8	29/32	3/8	5.0
RF1506-0806	1/4"	10.0	14.4	58.1	128.5	23.0	9.4	185	13/32	9/16	2 9/32	5 1/16	29/32	3/8	6.5
RF1506-0808	1/4"	13.9	17.5	70.9	141.3	29.4	12.4	276	17/32	11/16	2 25/32	5 9/16	1 5/32	1/2	9.7
RF1506-0908*2	9/32"	13.9	17.5	73.2	151.9	29.4	12.4	322	9/16	11/16	2 7/8	5 31/32	1 5/32	1/2	11.4
RF1506-1008*2	5/16"	13.9	17.5	72.1	160.6	29.4	12.4	356	9/16	11/16	2 27/32	6 11/32	1 5/32	1/2	12.6
RF1506-1010*2	5/16"	17.0	20.8	87.5	176.0	42.2	15.7	494	21/32	13/16	3 7/16	6 15/16	1 21/32	5/8	17.4
RF1506-1210	3/8"	17.0	20.8	87.7	198.2	42.2	15.7	554	21/32	13/16	3 7/16	7 13/16	1 21/32	5/8	19.5
RF1506-1412*2	7/16"	20.0	23.8	101.9	224.4	48.9	18.9	838	3/4	15/16	4	8 27/32	1 15/16	3/4	29.6
RF1506-1614	1/2"	26.6	28.5	116.5	257.0	44.4	22.0	1368	1 1/16	1 1/8	4 19/32	10 1/8	1 3/4	7/8	48.3
RF1506-1814*2	9/16"	26.5	28.5	120.4	278.3	44.4	22.0	1536	1 1/16	1 1/8	4 3/4	10 31/32	1 3/4	7/8	54.2
RF1506-2016*2	5/8"	29.3	31.8	147.8	324.5	60.3	25.2	2632	1 5/32	1 1/4	5 13/16	12 25/32	2 3/8	1	92.8

*1 Toggle swage terminal BL is below the typical BL of grade 1570, 1x19 stainless steel wire.

*2 Product supplied as the metric equivalent with metric wire code stamping.

Note: Larger sizes available to order.

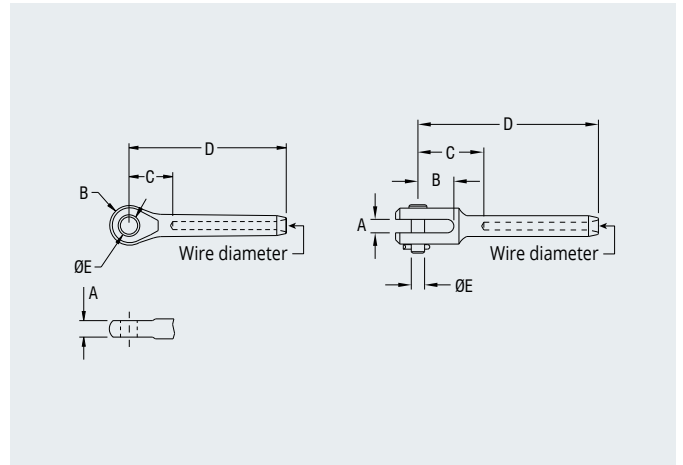
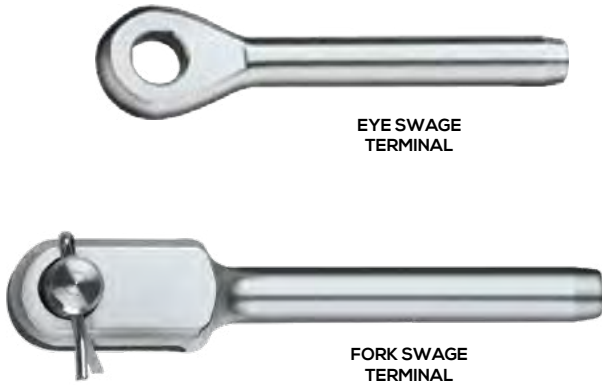

PRODUCT No.	WIRE DIAM.	A mm	B mm	C mm	D mm	E mm	WEIGHT g	A in	B in	C in	D in	E in	WEIGHT oz
-------------	------------	------	------	------	------	------	----------	------	------	------	------	------	-----------

Eye Swage Terminals - Metric Wire

RF1501M2.503	2.5mm	3.1	6.3	15.2	48.0	5.1	8	1/8	1/4	19/32	1 7/8	3/16	0.4
RF1501M0304	3mm	4.6	6.2	16.1	55.3	6.5	14	3/16	1/4	21/32	2 3/16	1/4	0.5
RF1501M0405	4mm	6.1	8.5	18.5	64.0	8.1	22	1/4	11/32	5/8	2 1/2	5/16	0.9
RF1501M0505	5mm	6.1	8.5	19.1	74.6	8.1	30	1/4	11/32	5/8	3	5/16	1.1
RF1501M0506	5mm	7.7	10.0	21.1	76.6	9.7	38	9/32	13/32	7/8	3 1/16	3/8	1.6
RF1501M0608	6mm	9.5	12.5	27.1	97.5	13.0	95	3/8	1/2	1 3/16	3 14/16	1/2	3.4
RF1501M0708	7mm	12.5	13.5	30.9	109.9	13.0	138	1/2	17/32	1 3/16	4 5/16	1/2	5.5
RF1501M0808	8mm	12.5	13.5	29.5	118.0	13.0	174	1/2	9/16	1 1/4	4 11/16	1/2	6.5
RF1501M0810	8mm	14.0	15.5	28.0	116.5	16.3	182	9/16	5/8	1 1/4	4 5/8	5/8	7.1
RF1501M1010	10 mm	14.0	15.5	29.0	139.5	16.3	228	5/8	5/8	1 7/16	5 3/4	5/8	9.9
RF1501M1112	11mm	15.5	18.2	35.9	158.6	19.5	324	23/32	23/32	1 1/2	6 1/4	3/4	9.9
RF1501M1212	12mm	15.5	19.5	42.4	182.8	19.5	420	5/8	11/16	1 5/8	7 1/8	3/4	14.1
RF1501M1414	14mm	20.0	23.2	54.2	212.1	22.5	746	27/32	15/16	2 3/16	8 5/16	7/8	28.1
RF1501M1616	16mm	25.0	27.2	58.1	234.8	25.8	1074	1	11/16	2 3/8	9 1/8	1	41.3

Eye Swage Terminals - Imperial Wire

RF1500-0303*	3/32"	3.1	6.3	15.2	48.0	5.1	8	1/8	1/4	19/32	1 7/8	3/16	0.4
RF1500-0404	1/8"	4.6	6.2	16.1	55.3	6.5	12	3/16	1/4	21/32	2 3/16	1/4	0.4
RF1500-0505*	5/32"	6.1	8.5	18.5	64.0	8.1	20	1/4	11/32	5/8	2 1/2	5/16	0.5
RF1500-0605	3/16"	6.1	8.5	19.1	74.6	8.1	32	1/4	11/32	5/8	3	5/16	1.1
RF1500-0606	3/16"	7.7	10.0	21.1	76.9	9.7	38	5/16	13/32	7/8	3 1/16	3/8	0.7
RF1500-0706	7/32"	7.7	10.0	22.4	83.4	9.7	56	3/8	13/32	1	3 5/16	3/8	1.3
RF1500-0808	1/4"	9.5	12.5	27.1	97.5	13.0	90	3/8	1/2	1 3/16	3 7/8	1/2	2.3
RF1500-0908*	9/32"	12.5	13.5	30.9	109.9	13.0	138	1/2	17/32	1 5/16	4 5/16	1/2	3.4
RF1500-1008*	5/16"	12.5	13.5	29.5	118.0	13.0	174	1/2	17/32	1 1/4	4 5/8	1/2	5.1
RF1500-1010*	5/16"	14.0	15.5	28.0	116.5	16.3	182	9/16	5/8	1 1/4	4 5/8	5/8	6.5
RF1500-1210	3/8"	14.0	15.5	29.0	139.5	16.3	232	9/16	5/8	1 1/2	5 5/8	5/8	7.8
RF1500-1412*	7/16"	15.5	18.2	35.9	158.6	19.5	324	23/32	23/32	1 1/2	6 1/4	3/4	9.9
RF1500-1614	1/2"	20.0	24.0	51.8	192.2	22.5	566	27/32	15/16	2 3/16	7 11/16	7/8	13.1
RF1500-1814*	9/16"	20.0	23.2	54.2	212.1	22.5	730	27/32	15/16	2 3/16	8 5/16	7/8	21.9
RF1500-2016*	5/8"	25.0	27.2	58.1	234.8	25.8	1070	1	11/16	2 3/8	9 1/4	1	29.6

PRODUCT No.	WIRE DIAM.	A mm	B mm	C mm	D mm	E mm	WEIGHT g	A in	B in	C in	D in	E in	WEIGHT oz
-------------	------------	------	------	------	------	------	----------	------	------	------	------	------	-----------

Fork Swage Terminals - Metric Wire

RF1509M0304	3mm	4.9	15.4	25.1	64.4	6.2	22	3/16	19/32	1	2 17/32	1/4	0.8
RF1509M0405	4mm	4.9	16.8	30.0	75.5	7.8	34	3/16	21/32	1 3/16	2 31/32	5/16	1.2
RF1509M0506	5mm	6.3	18.2	33.7	89.3	9.4	65	1/4	23/32	1 5/16	3 17/32	3/8	2.3

Fork Swage Terminals - Imperial Wire

RF1508-0404	1/8"	4.9	15.4	25.1	64.4	6.2	22	3/16	19/32	1	2 17/32	1/4	0.8
RF1508-0505*	5/32"	4.9	16.8	30.0	75.5	7.8	34	3/16	21/32	1 3/16	2 31/32	5/16	1.2
RF1508-0606	3/16"	6.3	18.2	33.7	89.3	9.4	65	1/4	23/32	1 5/16	3 17/32	3/8	2.3

* Product supplied as the metric equivalent with metric wire code stamping.



**DOUBLE JAW
TOGGLE**

✓ Double jaw toggles are supplied with washers and split pins as shown.

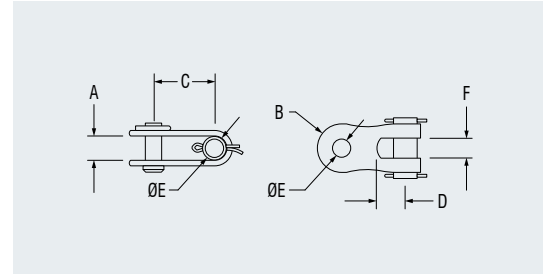

PRODUCT No.	PIN DIAM. mm	A mm	B mm	C mm	D mm	E mm	F mm	WEIGHT g	PIN DIAM. in	A in	B in	C in	D in	E in	F in	WEIGHT oz
Double Jaw Toggles																
RF1505-05	7.9	9.4	11.2	28.5	8.3	7.9	7.1	55	5/16	3/8	7/16	1 1/8	5/16	5/16	9/32	2.0
RF1505-06	9.4	10.0	14.4	32.5	10.2	9.4	8.8	99	3/8	13/32	9/16	1 9/32	3/8	3/8	11/32	3.5
RF1505-08	12.5	13.9	17.5	42.0	15.1	12.5	13.4	202	1/2	17/32	11/16	1 21/32	19/32	1/2	17/32	7.1
RF1505-10	15.7	17.0	20.8	57.6	18.1	15.7	15.5	350	5/8	21/32	13/16	2 9/32	5/8	5/8	5/8	12.4
RF1505-12	18.9	20.0	23.8	66.2	18.5	18.9	16.2	577	3/4	25/32	15/16	2 19/32	23/32	3/4	5/8	20.3



**LOCK NUT,
R/H THREAD**

PRODUCT No.	THREAD TYPE
Lock Nuts, R/H Thread	
RF1415-04	1/4" UNF
RF1415-05	5/16" UNF
RF1415-06	3/8" UNF
RF1415-08	1/2" UNF
RF1415-10	5/8" UNF
RF1415-12	3/4" UNF
RF1415-14	7/8" UNF
RF1415-16	1" UNF

SWAGING DIMENSIONS

Correct installation of a swage fitting requires that the swage portion of the fitting be formed down onto the wire with specialised dies and presses in accordance with the following dimensions:

WIRE DIAM. mm	CODE mm	LENGTH OF WIRE INSIDE SWAGE mm	O.D. BEFORE SWAGING mm	O.D. AFTER SWAGING mm	TOLERANCE ON O.D. mm
Swaging Dimensions - Metric Wire					
2.5	2.5M	32.3	5.54	4.83	+0, -0.13
3.0	03M	38.4	6.35	5.56	+0, -0.13
4.0	04M	45.0	7.54	6.35	+0, -0.13
5.0	05M	55.0	9.12	7.95	+0, -0.13
5.6	-	60.5	10.85	9.53	+0, -0.18
6.0	06M	70.0	12.55	11.13	+0, -0.18
7.0	07M	78.5	14.30	12.70	+0, -0.20
8.0	08M	88.0	16.13	14.30	+0, -0.20
10.0	10M	110.0	17.86	15.88	+0, -0.20
11.0	-	122.0	19.84	17.48	+0, -0.20
12.0	12M	140.0	21.44	19.05	+0, -0.23
14.0	14M	157.0	24.99	22.23	+0, -0.23
16.0	16M	176.0	28.17	25.40	+0, -0.26

WIRE DIAM. in	CODE in	LENGTH OF WIRE INSIDE SWAGE in	O.D. BEFORE SWAGING in	O.D. AFTER SWAGING in	TOLERANCE ON O.D. in
Swaging Dimensions - Imperial Wire					
3/32	03	1.27	0.218	0.190	+0, -0.005
1/8	04	1.51	0.250	0.219	+0, -0.005
5/32	05	1.77	0.297	0.250	+0, -0.005
3/16	06	2.17	0.359	0.313	+0, -0.005
7/32	07	2.38	0.427	0.375	+0, -0.007
1/4	08	2.76	0.494	0.438	+0, -0.007
9/32	09	3.09	0.563	0.500	+0, -0.008
5/16	10	3.46	0.635	0.563	+0, -0.008
3/8	12	4.33	0.703	0.625	+0, -0.008
7/16	14	4.80	0.781	0.688	+0, -0.008
1/2	16	5.51	0.844	0.750	+0, -0.009
9/16	18	6.18	0.984	0.875	+0, -0.009
5/8	20	6.93	1.109	1.000	+0, -0.010



SPLIT RINGS
RF113
RF114



SPLIT RINGS
RF686
RF687
RF688



RETAINING CLIP
RF413



CLEVIS PINS



FAST PIN
RF5310



TOGGLE PINS

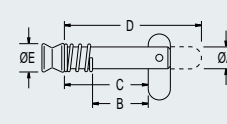
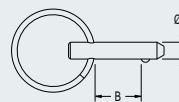
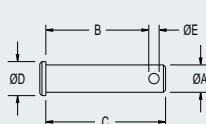
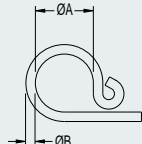
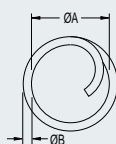
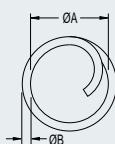

PRODUCT No.	SUITS CLEVIS PINS	DESCRIPTION	A mm	B mm	WEIGHT g	A in	B in	WEIGHT oz
-------------	-------------------	-------------	------	------	----------	------	------	-----------

Split Rings & Clips

RF113	RF258 - RF266	Split ring	9.5	1.0	1	3/8	1/32	0.1
RF114	RF260 - RF266	Split ring	11.1	1.3	2	7/16	1/16	0.1
RF413	RF267 - RF274	Retaining clip	16.0	2.7	3	5/8	3/32	0.1
RF686	RF260 - RF274	Split ring	14.3	1.3	4	9/16	1/16	0.1
RF687	RF260 - RF274	Split ring	18.8	1.6	5	3/4	1/16	0.2
RF688	RF267 - RF278	Split ring	25.0	2.0	5	1	3/32	0.2

PRODUCT No.	A mm	B mm	C mm	D mm	E mm	WEIGHT g	A in	B in	C in	D in	E in	WEIGHT oz
-------------	------	------	------	------	------	----------	------	------	------	------	------	-----------

Clevis Pins

RF259	4.6	9.0	12.2	6.4	2.0	2	3/16	11/32	15/32	1/4	5/64	0.1
RF260	4.8	12.7	16.0	6.4	2.2	3	3/16	1/2	5/8	1/4	3/32	0.1
RF261	4.8	19.0	22.0	6.4	2.2	3	3/16	3/4	7/8	1/4	3/32	0.1
RF262	4.8	25.0	28.0	6.4	2.2	5	3/16	1	1 1/8	1/4	3/32	0.2
RF263	6.4	12.7	16.5	7.9	2.4	5	1/4	1/2	21/32	5/16	3/32	0.2
RF264	6.4	19.0	23.0	7.9	2.4	5	1/4	3/4	29/32	5/16	3/32	0.2
RF265	6.4	25.0	30.0	7.9	2.4	10	1/4	1	1 3/16	5/16	3/32	0.4
RF266	6.4	32.0	36.0	7.9	2.4	10	1/4	1 1/4	1 7/16	5/16	3/32	0.4
RF267	7.9	12.7	16.5	9.5	2.7	10	5/16	1/2	21/32	3/8	3/32	0.4
RF268	7.9	19.0	23.0	9.5	2.7	10	5/16	3/4	29/32	3/8	3/32	0.4
RF269	7.9	25.0	30.0	9.5	2.7	10	5/16	1	1 3/16	3/8	3/32	0.4
RF270	7.9	32.0	36.0	9.5	2.7	15	5/16	1 1/4	1 7/16	3/8	3/32	0.5
RF271	9.5	19.0	24.0	12.7	4.0	15	3/8	3/4	15/16	1/2	5/32	0.5
RF272	9.5	25.0	31.0	12.7	3.6	20	3/8	1	1 1/4	1/2	5/32	0.7
RF273	9.5	32.0	37.0	12.7	3.7	20	3/8	1 1/4	1 7/16	1/2	5/32	0.7
RF274	9.5	38.0	43.0	12.7	3.7	25	3/8	1 1/2	1 11/16	1/2	5/32	0.9
RF275	12.7	19.0	25.0	15.9	3.5	30	1/2	3/4	1	5/8	1/8	1.1
RF276	12.7	25.0	31.0	15.9	3.5	35	1/2	1	1 1/4	5/8	1/8	1.2
RF277	12.7	32.0	38.0	15.9	3.5	40	1/2	1 1/4	1 1/2	5/8	1/8	1.4
RF278	12.7	38.0	44.0	15.9	3.5	50	1/2	1 1/2	1 3/4	5/8	1/8	1.8
RF537	15.9	25.0	33.0	19.0	4.0	55	5/8	1	1 5/16	3/4	5/32	1.9
RF538	15.9	32.0	38.0	19.0	4.4	65	5/8	1 1/4	1 1/2	3/4	5/32	2.3
RF539	15.9	38.0	45.0	19.0	4.4	75	5/8	1 1/2	1 3/4	3/4	5/32	2.7

Fast Pin

RF5310	4.8	12.5	-	-	-	7	3/16	1/2	-	-	-	0.2
--------	-----	------	---	---	---	---	------	-----	---	---	---	-----

Toggle Pins

RF115 x 1/2	6.4	7.8*	17.4	32.5	7.9	10	1/4	5/16*	11/16	1 9/32	5/16	0.4
RF115 x 5/8	6.4	11.2*	20.8	35.9	7.9	10	1/4	7/16*	13/16	1 13/32	5/16	0.4
RF115 x 3/4	6.4	14.2*	23.8	38.9	7.9	10	1/4	9/16*	15/16	1 17/32	5/16	0.4
RF115 x 1	6.4	20.5*	30.1	45.2	7.9	10	1/4	13/16*	1 1/8	1 25/32	5/16	0.4
RF115 x 1 1/4	6.4	27.1*	36.7	51.8	7.9	13	1/4	1 1/16*	1 7/16	2	5/16	0.5

*Maximum thickness of material the toggle pin can pass through, allowing correct toggle operation.



THIMBLES



SAILMAKER THIMBLES



COPPER FERRULES



WIRE ROPE GRIPS

✔ Copper ferrules are nickel plated for aesthetic appearance and long-term weather resistance.

✔ Stainless steel wire rope grips require no special tools for assembly and can be disassembled and reused.

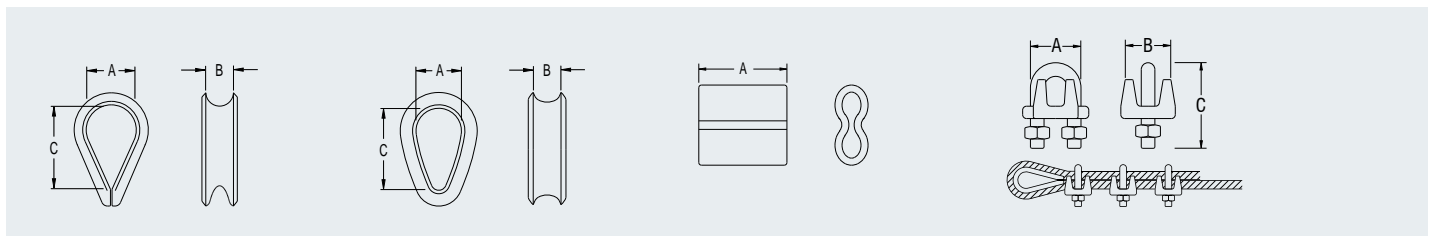

PRODUCT No.	WIRE DIAM. mm	A mm	B mm	C mm	WEIGHT g	WIRE DIAM. in	A in	B in	C in	WEIGHT oz
Thimbles - Stainless Steel										
RF481	2.5	9.0	3.0	16	2	3/32	11/32	1/8	5/8	0.1
RF482	3.0	10.0	4.0	18	2	1/8	3/8	5/32	23/32	0.1
RF483	4.0	11.0	5.0	19	5	5/32	7/16	3/16	3/4	0.2
RF484	5.0	13.0	6.0	23	5	3/16	1/2	1/4	29/32	0.2
RF485	6.0, 7.0	19.0	9.0	36	15	1/4, 9/32	3/4	11/32	1 3/8	0.5
RF486	8.0	21.0	10.5	38	25	5/16	13/16	13/32	1 1/2	0.9
RF487	10.0	27.0	11.5	53	40	3/8	1 1/16	7/16	2 1/16	1.4
RF2488	12.0	29.0	15.5	55	65	1/2	1 1/8	5/8	2 3/16	2.3
RF2490	16.0	40.0	20.0	67	125	5/8	1 9/16	25/32	2 5/8	4.4
RF2492	19.0	51.0	22.0	87	275	3/4	2	7/8	3 7/16	9.7
RF2494	26.0	65.0	29.0	115	615	1	2 1/2	1 1/8	4 1/2	21.7
Sailmaker Thimbles - Stainless Steel										
RF2180	3.0	9.0	4.5	16	3	1/8	11/32	3/16	5/8	0.1
RF2181	4.0	11.0	5.5	20	5	5/32	7/16	7/32	25/32	0.2
RF2182	5.0	17.0	6.3	27	10	3/16	21/32	1/4	1 1/16	0.4
RF2183	6.0	21.0	8.5	33	20	1/4	13/16	11/32	1 5/16	0.7
RF2184	8.0	26.0	11.0	40	40	5/16	1	7/16	1 9/16	1.4
Copper Ferrules										
RF3169	1.5	8.0	-	-	2	1/16	5/16	-	-	0.1
RF3170	2.0	10.0	-	-	2	5/64	3/8	-	-	0.1
RF3171	2.5	11.0	-	-	3	3/32	7/16	-	-	0.1
RF3172	3.0	14.0	-	-	5	1/8	9/16	-	-	0.2
RF3173	4.0	18.5	-	-	10	5/32	23/32	-	-	0.4
RF3174	5.0	19.0	-	-	15	3/16	3/4	-	-	0.5
RF3175	6.0	20.0	-	-	22	1/4	25/32	-	-	0.8
Wire Rope Grips										
RF1685-2	2.0	14.0	14.0	18	10	5/64	23/32	23/32	11/16	0.3
RF1685-4	4.0	18.0	18.0	24	20	5/32	11/16	23/32	15/16	0.7
RF1685-5	5.0	18.0	20.0	28	30	3/16	11/16	13/16	1 1/8	1.0
RF1685-6	6.0	21.0	21.0	33	40	1/4	27/32	27/32	1 9/32	1.4
RF1685-8	8.0	27.0	24.0	43	80	5/16	1 1/16	15/16	1 5/8	2.8
RF1685-10	10.0	31.6	34.0	51	140	3/8	1 7/8	1 5/16	2	4.9
RF1685-12	12.0	37.7	36.0	65	220	1/2	1 1/2	1 7/16	2 9/16	7.7

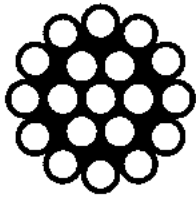

**1 X 19
CONSTRUCTION**
19 single strands

- ✓ Strongest
- ✓ Lowest stretch
- ✓ Least flexible
- ⬆ Standing rigging
- ⬆ Life lines

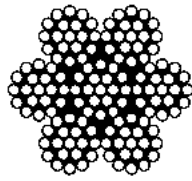

**7 X 19
CONSTRUCTION**
7 strands of 19 wires

- ✓ Most flexible
- ⬆ Halyards
- ⬆ Steering
- ⬆ Running rigging
- ⬆ Vang cascades

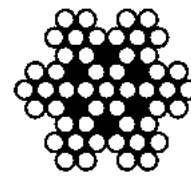

**7 X 7
CONSTRUCTION**
7 strands of 7 wires

- ✓ Semi-flexible
- ✓ PVC coated (optional)
- ⬆ Soft luff dinghy forestay (coilable)
- ⬆ Removable dinghy stays (coilable)

STRETCH IN WIRE

Stretch is a characteristic of all wire, initially as permanent stretch when the load is first applied and the individual wires bed down, and then as conventional elastic stretch within the wires as load increases. Where stretch is critical to the application, initial stretch can be accounted for with cables stretched (pre-stressed) during swaging and cable manufacturing. Elastic stretch can be estimated by the following formula:

$$\text{Elastic stretch (mm)} = \frac{W \times L}{E \times A}$$

where:

W = Applied load (kN)

L = Cable length (mm)

E = Strand modulus (kN/mm²)

A = Metallic Cross Sectional Area (mm²) as indicated in the tables below

Typical values for E are:

1 x 19 127 kN/mm² (18.42 x 10⁶ P.S.I.)

7 x 19 97.1 kN/mm² (14.08 x 10⁶ P.S.I.)

7 x 7 106 kN/mm² (15.37 x 10⁶ P.S.I.)

PRODUCT No.	WIRE DIAM. mm	A mm ²	REEL LENGTH m	B.L.* ³ kg	WEIGHT PER METRE kg	A in ²	REEL LENGTH ft	B.L.* ³ lb	WEIGHT PER 100ft lb
1 x 19 Grade 316 Stainless Steel [Tensile Strength Grade 1570 N/mm²]*¹									
WR6119-1.5M	1.5	1.3	305	180	0.012	0.002	1000	397	0.77
WR6119-02M	2.0	2.3	305	330	0.020	0.004	1000	728	1.37
WR6119-2.5M	2.5	3.7	305	530	0.032	0.006	1000	1168	2.14
WR6119-03M	3.0	5.4	305	760	0.046	0.008	1000	1675	3.09
WR6119-04M	4.0	9.6	305	1350	0.082	0.015	1000	2975	5.49
WR6119-05M	5.0	15.0	305	2100	0.128	0.023	1000	4630	8.61
WR6119-06M	6.0	21.5	305	3020	0.184	0.033	1000	6657	12.37
WR6119-07M	7.0	29.2	305	4130	0.250	0.045	1000	9105	16.81
WR6119-08M	8.0	38.2	305	5380	0.320	0.059	1000	11860	21.92
WR6119-10M	10.0	59.7	305	8420	0.510	0.093	1000	18562	34.29
WR6119-12M	12.0	86.0	305	12130	0.734	0.133	1000	26742	49.35
WR6119-14M	14.0	117.0	305	16510	1.000	0.181	1000	36398	67.24
WR6119-16M	16.0	153.0	305	21510	1.310	0.237	1000	47421	88.09
7 x 19 Grade 316 Stainless Steel									
WR6719-1.5M	1.5	1.2	305	150	0.009	0.002	1000	331	0.62
WR6719-02M	2.0	2.0	305	250	0.016	0.003	1000	551	1.10
WR6719-2.5M	2.5	3.2	305	380	0.026	0.005	1000	838	1.72
WR6719-03M	3.0	4.6	305	540	0.037	0.007	1000	1191	2.47
WR6719-04M	4.0	8.2	305	960	0.066	0.013	1000	2117	4.40
WR6719-05M	5.0	12.9	305	1480	0.103	0.020	1000	3263	6.90
WR6719-06M	6.0	18.5	305	2150	0.148	0.029	1000	4740	9.92
WR6719-07M	7.0	25.1	305	2920	0.201	0.039	1000	6439	13.47
WR6719-08M	8.0	32.8	305	3810	0.262	0.051	1000	8401	17.55
WR6719-10M	10.0	51.3	305	5960	0.410	0.080	1000	13140	27.47
WR6719-12M	12.0	73.8	305	8600	0.590	0.114	1000	18960	39.53
WR6719-14M	14.0	100.5	305	11690	0.804	0.156	1000	25772	53.87
WR6719-16M	16.0	131.3	305	14450	1.050	0.204	1000	31857	70.35
7 x 7 Grade 316 Stainless Steel									
WR677-03M	3.0	4.2	305	580	0.037	0.007	1000	1279	2.35
WR677-04M	4.0	7.5	305	1040	0.066	0.012	1000	2293	4.23
WR677-03MP* ²	3.0	4.2	305	580	0.055	0.007	1000	1279	4.84

*1 Larger diameters available on request.

*2 Wire diameter excludes PVC Coating, Ø including PVC = 5.0mm

*3 Cable Breaking Load: does not include the typical 10% reduction in cable strength due to swaging. B.L. ratings are for standard Ronstan mill ordered, and stocked wire. From time to time wire may be sourced from other suppliers and ratings may vary.





SOFT LINK



SOFT SHACKLE

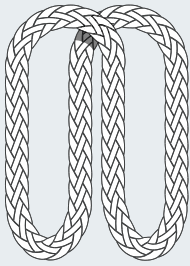

Basket Load

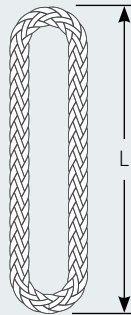

Vertical Load

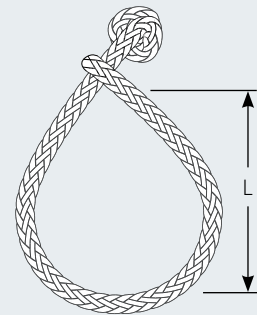

✔ Small diameter puller line allows for easy removal after soft shackle being loaded.

⬇️ Alternative to traditional metal shackles.

⚙️ SK78 Dyneema®.

✔ Lightweight and easy on the boat.

⚙️ XG coating for UV stability and resistance to abrasion.

PRODUCT No.	DESCRIPTION	WHERE USED	DIAM. mm	L mm	B.L.* BASKET kg	B.L.* VERTICAL kg	WEIGHT g	DIAM. in	L in	B.L.* BASKET lb	B.L.* VERTICAL lb	WEIGHT oz
Soft Links												
RF9003-07	Soft Link	S30 Double & Triple, S40 Single & Fiddle Blocks	3.0	70	1200	600	1	1/8	2 3/4	2645	1320	0.1
RF9004-08	Soft Link	S40 Single & Fiddle, S55 Single & Fiddle Blocks	4.0	76	1800	900	1	5/32	3	2970	1985	0.1
RF9004-09	Soft Link	S40 Double & Triple Blocks	4.0	95	1800	900	2	5/32	3 3/4	2970	1985	0.1
RF9004-11	Soft Link		4.0	110	1800	900	2	5/32	4 11/32	2970	1985	0.1
RF9004-13	Soft Link	RC72541	4.0	128	1800	900	2	5/32	5 2/16	2970	1985	0.1
RF9005-10	Soft Link	S55 Double & Triple Blocks	5.0	100	2400	1200	3	3/16	3 15/16	5290	2645	0.1
RF9006-12	Soft Link		6.0	120	3400	1700	5	1/4	4 3/4	7495	3750	0.2
Soft Shackles												
DSH-2.5GRY	Soft Shackle		2.5	50	-	700	10	3/32	1 31/32	-	1540	0.4
DSH-4GRY	Soft Shackle		4.0	65	-	1000	15	5/32	2 9/16	-	2200	0.6
DSH-6GRY	Soft Shackle		6.0	90	-	2000	18	1/4	3 17/32	-	4410	0.7
DSH-9GRY	Soft Shackle		9.0	100	-	4000	20	11/32	3 15/16	-	8820	0.7
DSH-12GRY	Soft Shackle		12.0	70	-	5900	40	1/2	2 3/4	-	13010	1.4
DSH-14GRY	Soft Shackle		14.0	100	-	7000	60	9/16	3 15/16	-	15430	2.2

* Considerations: Published breaking loads are based on as new condition. Fatigue, wear and UV exposure will deteriorate performance. Inspect regularly and replace if there are significant amount of wear or fibre damage. Attach to a mounting point with a smooth, well rounded profile without sharp edges or burrs.

CARABINER HOOKS

ASYMMETRICAL SNAP HOOKS

SPRING SNAP HOOKS

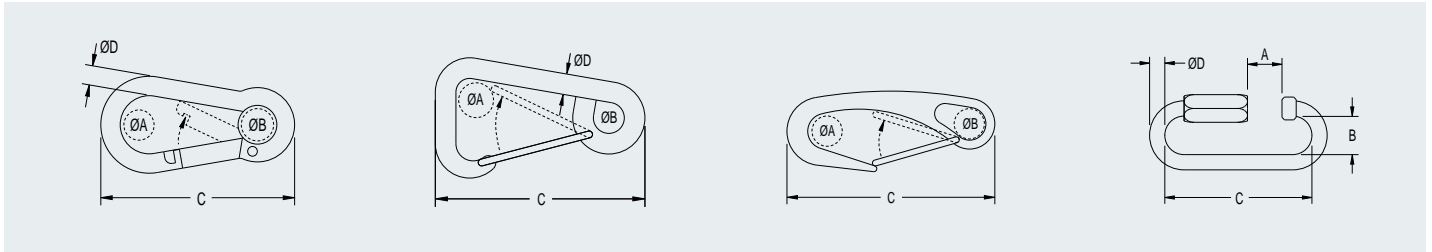
QUICKLINKS

PRODUCT No.	DESCRIPTION	A	B	C	D	WEIGHT	A	B	C	D	WEIGHT
		mm	mm	mm	mm	g	in	in	in	in	oz
Carabiner Hook											
CS2450-5		8	6	50	5	17	5/16	1/4	2	3/16	0.6
CS2450-6		9	6	60	6	28	3/8	1/4	2 3/8	1/4	1.0
CS2450-8		11	10	81	8	67	7/16	3/8	3 3/16	5/16	2.3
CS2450-10		13	14	100	10	128	1/2	9/16	3 15/16	13/32	4.5
Asymmetrical Snap Hook											
CS2430-6		17	9	60	6	27	11/16	3/8	2 3/8	1/4	0.9
CS2430-8		25	12	80	7.5	66	1	15/32	3 3/16	5/16	2.3
CS2430-10		27	13	101	10	140	1 1/16	1/2	4	3/8	4.9
CS2430-12		33	16	121	12	220	1 5/16	5/8	4 3/4	15/32	7.7
Spring Snap Hook											
CS2470-50		10	6	50	-	18	3/8	1/4	2	-	0.6
CS2470-70		12	10	70	-	47	15/32	3/8	2 3/4	-	1.6
CS2470-100		18	12	100	-	108	23/32	15/32	3 15/16	-	3.8
Quicklinks											
CS7350-4		6.0	11	33	4	13	1/4	7/16	1 5/16	5/32	0.4
CS7350-6		7.0	15	47	6	37	9/32	19/32	1 7/8	1/4	1.3
CS7350-8		9.5	18	58	8	80	3/8	11/16	2 5/16	5/16	2.8
CS7350-10		13.0	20	70	10	143	1/2	25/32	2 3/4	3/8	5.0



© Myriam Thyès / www.thyes.com



SNAP SHACKLES - FIXED EYE



SNAP SHACKLES - SWIVEL EYE



PAD EYES - SQUARE



EYE COACH SCREWS

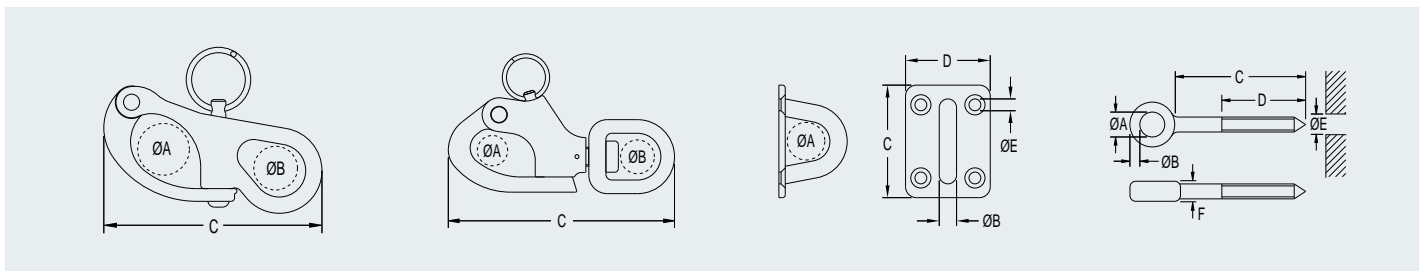

PRODUCT No.	THREAD	A mm	B mm	C mm	D mm	E mm	F mm	WEIGHT g	A in	B in	C in	D in	E in	F in	WEIGHT oz
Snap Shackle - Fixed Eye															
CS2483-1		11	10	54	-	-	-	47	7/16	3/8	2 1/8	-	-	-	1.6
CS2483-2		18	14	70	-	-	-	95	11/16	9/16	2 3/4	-	-	-	3.3
Snap Shackle - Swivel Eye															
CS2482-1		14	12	67	-	-	-	58	9/16	15/32	2 5/8	-	-	-	2.0
CS2482-2		17	16	88	-	-	-	120	5/8	5/8	3 7/16	-	-	-	4.2
Pad Eyes - Square															
CS321-6	-	17	6	40	34	5	-	38	21/32	1/4	1 9/16	1 5/16	3/16	-	1.3
CS321-8	-	21	8	50	39	6	-	64	13/16	5/16	2	1 17/32	1/4	-	2.2
Eye Coach Screws															
CS3182-555	-	5	4	60	41	4	5	15	3/16	5/32	2 3/8	1 5/8	5/32	3/16	0.6
CS3182-860	-	8	5	96	54	6	9	34	5/16	3/16	3 3/4	2 1/8	1/4	3/8	1.2

Note - Commodity stainless product dimensions are indicative and subject to change

OUTSIDE MOUNT
INSIDE MOUNT

RA554130



RA554131



RA435200



RA554136

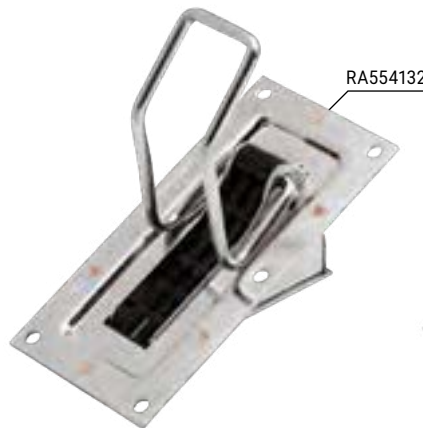

RA554132

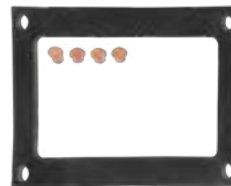

RA554133

 RA574153
RA574154

 RA574150
RA574151
RA574152

- ✔ Recognised as the industry standard for automatic bailers.
- ✔ Ingenious design uses venturi effect to produce suction and maximise water transfer – simply open the bailer when the boat is sailing at adequate speed to drain. Close when stationary or at low speed.
- ✔ Available in outside mount and inside mount models.
- ✔ Inside mount models have a plastic grate to prevent lines being sucked out.
- ✔ Robust stainless steel construction, provides long trouble free service life.
- ✔ Bailer and service kit installation instructions are available in the SUPPORT section at www.ronstan.com.
- ✔ Effective means of automatic bailing for dinghies and small one design keelboats.
- ⬆ Install on port and starboard sides for optimum bailing on both tacks.
- ⬆ RA435200 Super Mini Special bailer is designed for racing dinghies where the bailer is operated from a hiking position.
- ⚙ Stainless steel construction.
- ⚙ Rubber gaskets.

PRODUCT No.	DESCRIPTION	SIZE OF DRAINAGE OPENING mm ²	FLANGE SIZE mm	CUTOUT HOLE mm	NOMINAL HULL THICKNESS mm	WEIGHT g	SIZE OF DRAINAGE OPENING in ²	FLANGE SIZE in	CUTOUT HOLE in	NOMINAL HULL THICKNESS in	WEIGHT oz	SERVICE KIT
Bailers - Outside Mount												
RA554130	Mini	255	56 x 92	38 x 73	4	100	0.395	2 1/4 x 3 5/8	1 1/2 x 2 7/8	5/32	3.5	RA574153
RA554136	Large	435	80 x 142	41 x 104	4	275	0.674	3 3/16 x 5 9/16	1 5/8 x 4 1/8	5/32	9.7	RA574154
Bailers - Inside Mount												
RA435200	Super Mini Special*	250	61 x 106	40 x 85	7	175	0.387	2 7/16 x 4 3/16	1 5/8 x 3 3/8	1/4	6.2	RA574150
RA554131	Super Mini	250	61 x 106	40 x 85	7	175	0.387	2 7/16 x 4 3/16	1 5/8 x 3 3/8	1/4	6.2	RA574150
RA554132	Super Medium	350	67 x 135	43 x 110	7	275	0.543	2 11/16 x 5 5/16	1 3/4 x 4 3/8	1/4	9.7	RA574151
RA554133	Super Max	540	78 x 135	54 x 110	7	320	0.837	3 1/8 x 5 5/16	2 1/8 x 4 3/8	1/4	11.3	RA574152
Service Kits												
RA574150	Service kit to suit Super Mini bailer (RA554131). Includes internal and external gaskets, rivets											
RA574151	Service kit to suit Super Medium bailer (RA554132). Includes internal and external gaskets, rivets											
RA574152	Service kit to suit Super Max bailer (RA554133). Includes internal and external gaskets, rivets											
RA574153	Service kit to suit Mini bailer (RA554130). Includes internal gasket											
RA574154	Service kit to suit Large bailer (RA554136). Includes internal gasket											

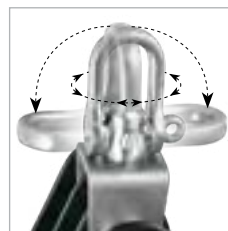
*Super Mini Special is designed for racing dinghies where the bailer is operated from a hiking position using a control line.



Swivelling & pivoting shackle head

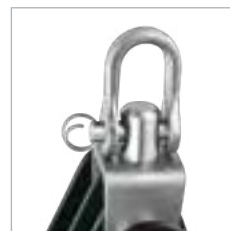

Clevis pin shackle option

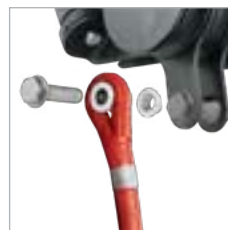

Removable becket pins

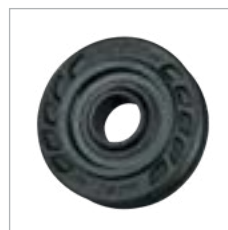

Durable, UV stabilised sheaves



Aluminium Rope/Wire sheave (S75)

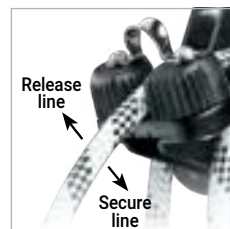

Simple and secure rope cleating

INDUSTRIAL PULLEY BLOCKS

INDUSTRIAL GRADE CONSTRUCTION, RELIABILITY & PERFORMANCE

Ronstan's Industrial Pulley Blocks offer a high quality, reliable solution for a myriad of applications. Full stainless steel housings and attachment fittings provide ultimate durability, long service life and resistance to harsh environments. Self-lubricating acetal polymer sheaves running on polished stainless steel races perform equally well with dynamic loads and high static loads, and an alloy sheave option is available for use with wire rope. Ronstan Industrial Blocks are load rated and are backed by a full factory warranty.

Swivelling and pivoting shackle head

Allows easy attachment and correct alignment of the pulley block. Shackle pins are drilled for use of security wire. The option of shackle with clevis pin and retaining ring is available in Series 75 - order as RZxxxxC. Provides tool-free attachment and removal.

Removable becket to suit pre-spliced lines

Pre-spliced lines are neat, compact and provide greater security and strength than knotted terminations. Becket on all Ronstan Industrial Blocks are removable to accommodate the use of pre-spliced lines.

Simple and secure rope holding

Blocks fitted with cam cleats provide a simple means of holding the rope. Just pull the rope through the spring-loaded jaws, which prevent the rope from slipping back. Flick the rope up and out of the jaws to release. A stainless steel eye strap keeps the rope in position ready for re-cleating.

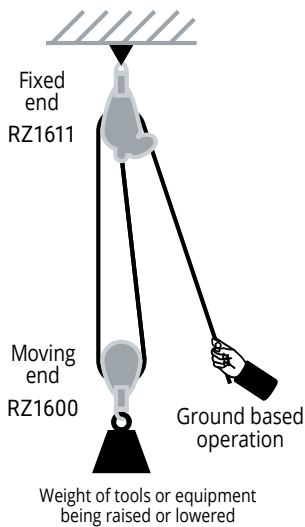
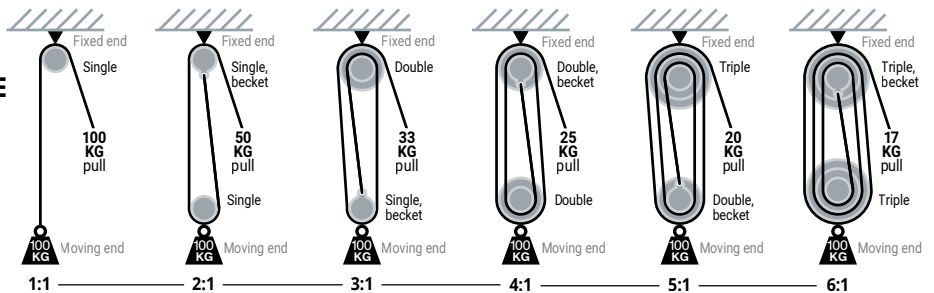
TYPICAL PURCHASE SYSTEMS
MECHANICAL ADVANTAGE*

- ✔ Load rated.
- ✔ Fully articulating head/attachment.
- ✔ Durable, low friction acetal polymer sheave.

- ✔ RZ1611 has a cleating angle of 60° from the mounting plane and is ideal for 'remote' operation as in the case of a ground based assistant raising tools or equipment to an overhead worker.
- ✔ UV stabilised acetal sheaves.

- ✔ Grade 316 stainless steel side plate/cheeks, powder coated black.
- ✔ Fibre reinforced polymer rope cleats.
- ✔ Grade 316 stainless steel head, shackle, becket and fastenings.

PRODUCT No.	DESCRIPTION	SHEAVE DIAM.	MAX. ROPE	PIN DIAM.	M.W.L.	B.L.	WEIGHT	SHEAVE DIAM.	MAX. ROPE	PIN DIAM.	M.W.L.	B.L.	WEIGHT
		mm	mm	mm	kg	kg	g	in	in	in	lb	lb	oz
Industrial Pulley Blocks													
RF617H	Shackle, 6mm (1/4") screw pin with security wire hole	-	-	6	1000*2	2000*2	25	-	-	1/4	2200*2	4410*2	0.9
RZ1600	Single block, swivel shackle head	60	12	6	1000	2000	390	2 3/8	1/2	1/4	2200	4410	13.8
RZ1603	Single block, becket, swivel shackle head	60	12	6	1000	2000	460	2 3/8	1/2	1/4	2200	4410	16.3
RZ1607	Single block, becket, 30° cleat, swivel shackle head	60	12	6	1000*1	2000	705	2 3/8	1/2	1/4	2200*1	4410	24.9
RZ1611	Single block, becket, 60° cleat, swivel shackle head	60	12	6	1000*1	2000	795	2 3/8	1/2	1/4	2200*1	4410	28.1

*1 Line load through cleat not to exceed 300kg (660lb).

*2 Uniformly distributed load on shackle; i.e. load applied across the full width of the shackle pin. See page 202 for full details.



PRODUCT No.	DESCRIPTION	SHEAVE	MAX.	PIN	M.W.L.	B.L.	WEIGHT	SHEAVE	MAX.	PIN	M.W.L.	B.L.	WEIGHT
		DIAM.	ROPE	DIAM.	kg	kg	g	DIAM.	ROPE	DIAM.	lb	lb	oz
		mm	mm	mm				in	in	in			
Industrial Pulley Blocks													
RZ1700	Single block, swivel shackle head	75	14	8	1500	3000	630	3	9/16	5/16	3300	6600	22.2
RZ1700AW	Single block, swivel shackle head, aluminium rope/wire sheave	75	8	8	1500	3000	740	3	5/16	5/16	3300	6600	26.1
RZ1703	Single block, becket, swivel shackle head	75	14	8	1500	3000	730	3	9/16	5/16	3300	6600	25.7
RZ1705	Double block, swivel shackle head	75	14	8	1500	3000	940	3	9/16	5/16	3300	6600	33.2
RZ1706	Double block, becket, swivel shackle head	75	14	8	1500	3000	1040	3	9/16	5/16	3300	6600	36.7
RZ1708	Triple block, swivel shackle head	75	14	8	1500	3000	1240	3	9/16	5/16	3300	6600	43.7
RZ1709	Triple block, becket, swivel shackle head	75	14	8	1500	3000	1325	3	9/16	5/16	3300	6600	46.7



- ✔ Load rated.
- ✔ Fully articulating head/attachment.
- ✔ Easy to service removable sheaves (bolt & nylon-insert nut).
- ✔ Durable, low friction acetal polymer sheave.

- ✔ Heavy duty aluminium sheave models available ('AW' suffix) or by conversion with RZ1000AW sheave.
- ✔ Blocks available to order with clevis pin and retaining ring shackle head.
- ✔ UV stabilised acetal sheaves.
- ✔ Aluminium sheave on 'AW' models.

- ✔ Grade 316 stainless steel side plate/cheeks, powder coated black.
- ✔ Fibre reinforced polymer rope cleats.
- ✔ Grade 316 stainless steel head, shackle and fasteners.

PRODUCT No.	DESCRIPTION	SHEAVE DIAM.	MAX. ROPE	PIN DIAM.	M.W.L.	B.L.	WEIGHT	SHEAVE DIAM.	MAX. ROPE	PIN DIAM.	M.W.L.	B.L.	WEIGHT
		mm	mm	mm	kg	kg	g	in	in	in	lb	lb	oz
Industrial Pulley Blocks													
RZ1707	Single block, becket, 30° cleat, swivel shackle head	75	14	8	1500*1	3000	955	3	9/16	5/16	3300*1	6600	33.7
RZ1710	Triple block, becket, 30° cleat, swivel shackle head	75	14	8	1500*1	3000	1565	3	9/16	5/16	3300*1	6600	55.2

PRODUCT No.	DESCRIPTION	SHEAVE DIAM.	MAX. WIRE	MAX. ROPE	M.W.L.	B.L.	WEIGHT	SHEAVE DIAM.	MAX. WIRE	MAX. ROPE	M.W.L.	B.L.	WEIGHT
		mm	mm	mm	kg	kg	g	in	in	in	lb	lb	oz
Accessories													
RF618H	Shackle, 7.9mm (5/16") diameter screw pin with security wire hole	-	-	-	1500*2	3300*2	50	-	-	-	3300*2	6600*2	1.5
RZ1000	Sheave, acetal (POM)	75	-	14	-	-	70	3	-	9/16	-	-	2.5
RZ1000AW	Sheave, aluminium with solid brass bearing	75	8	-	-	-	180	3	9/16	-	-	-	6.4

*1 Line load through cleat not to exceed 300kg (660lb).

*2 Uniformly distributed load on shackle; i.e. load applied across the full width of shackle pin. See page 202 for full details.

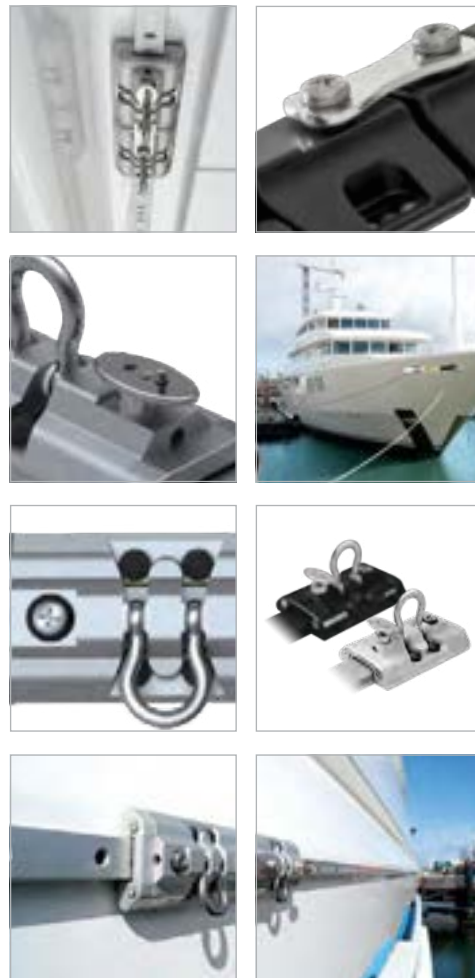

SAFETY RAIL SYSTEMS

A HIGHER STANDARD OF SAFETY

Track and car systems and single point anchorage systems have long been used to provide a mobile attachment point for crew when cleaning the hull, superstructure and windows of large motor yachts and other vessels.

With today's greater awareness of workplace risks, boat builders and surveyors are seeking to ensure a high standard of safety by specifying systems that are purpose designed, tested and standards-approved.

Ronstan supports this approach, which can only improve the safety and security of the persons using these systems in their everyday work, and has developed Safety Rail & Single Point Anchorage systems which have been tested and certified by Lloyd's Register to the relevant European and Australian Standards.

Purpose

Ronstan Fall Protection Systems provide a method of attachment for use in conjunction with personal protection equipment to protect against falls from a height, such as when working outside of conventional guardrails for cleaning and maintenance purposes on motor yachts or other vessels. They should not be used for any other purpose.

Features

SAFETY RAIL SYSTEMS

- Certified to European Standard EN795:2012, Type D (S22 system also certified to Australian Standard AS1891.2:2001, Part 2).
- Marine grade aluminium alloy cars, track rails and end stops, anodised for corrosion protection and long service life.
- Recirculating Torlon® ball bearings for free running, low friction performance and low maintenance.
- Grade 316 forged stainless steel pivoting shackles for lanyard attachment.
- Rubber buffers for reduced vibration and to lift pivoting shackles away from car body for quick access.
- Spring-loaded stainless steel plunger for simple, positive repositioning at stop locations. Can be locked in the disengaged position to allow free movement along the track rail. The elliptical knob is easy to grip and turn, and indicates clearly whether the plunger is engaged or not.

SINGLE POINT ANCHORAGE SYSTEMS

- Removable Screw-In padeye anchorages are certified to the European standard EN795:2012, Type A, as well as the Australian standards AS1891.4:2009 & AS5532:2013.
- Marine grade 316 stainless steel structural anchor base, screw-in anchor device and identification plate.
- Identification plate features the unique serial number.
- The screw-in anchor device can be removed from the structural anchor base when not in use for safety or maintenance. It should always be locked to the base when in use using the locking screw.

SAFETY RAIL SYSTEM SYSTEM DESCRIPTION

The complete Safety Rail System consists of the following components:

- One track rail with stop holes at 50mm centres and mounting holes at 100mm centres (centre of the last mounting hole at each end of the track rail is located 48mm from the end).
- One tandem sliding car assembly consisting of two cars joined together with a connecting plate.
 - Each car has a single attachment point for personal protection equipment.
 - One of the cars has a spring-loaded plunger to allow the assembly to be fixed in position at any of the stop holes in the track rail. This plunger can be disengaged to allow free movement of the car assembly along the rail.
- Two end stops installed at the extremities of the track rail.

OPTIONS

- Longer runs can be achieved by using more than one section of track rail and trimming to length as required, provided that the distance between mounting fasteners never exceeds 100mm. The joining insert should be used to aid alignment when fitting multiple sections of track rail.
- Additional sliding cars for supporting tools or equipment can be connected to the main tandem car with the connector plate.
- Optional end stop cover plates.
- Black or silver anodised cars and track.

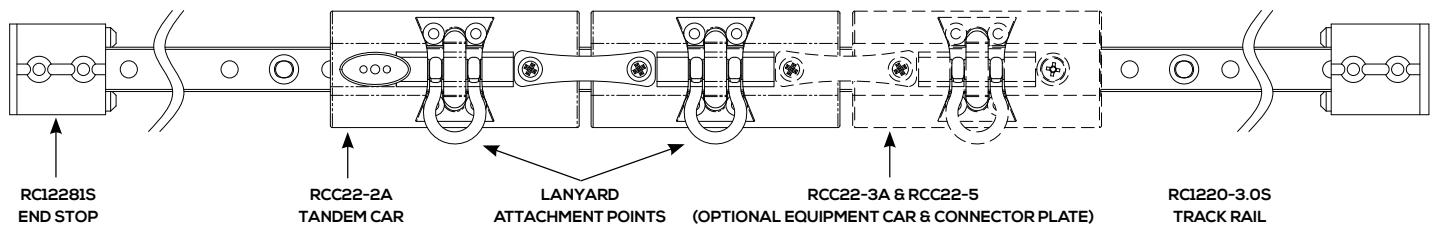

TRACK RAIL MOUNTED IN VERTICAL PLANE



TRACK RAIL MOUNTED IN HORIZONTAL PLANE

IMPORTANT ADVICE

Ronstan Fall Protection Systems are tested and certified to relevant European and Australian Standards, by Lloyd's Register, Copenhagen (Denmark), and are appropriate for single person use with an energy absorber to the EN355 standard. They must only be used with personal protection equipment (harnesses, lanyards, fall arresters and other devices) that are

approved to the relevant CE or other standards for such equipment. Each harness or device must be secured to a separate attachment point. Full product range details can be found at www.ronstan.com. Installation, usage and maintenance information is available under the **SUPPORT** tab on the site.



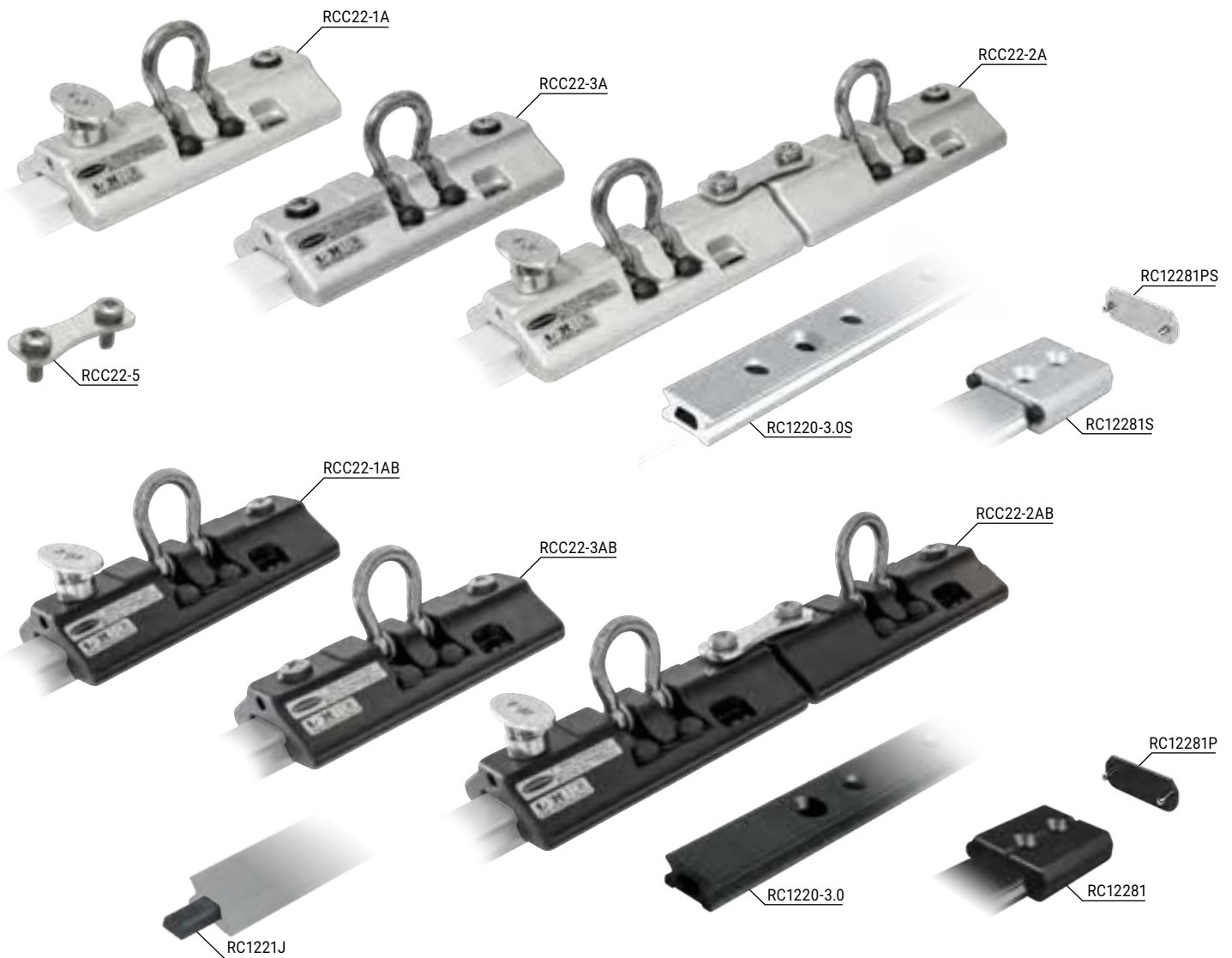

Full installation, usage and maintenance details available under the **SUPPORT** tab at www.ronstan.com.

- ✔ Certified to European Standard EN795:2012 Type D and Australian Standard AS1891.2.2001, Part 2.
- ✔ Low friction.
- ✔ Anti-clatter rubber buffers.
- ✔ Lock up/down track position plunger stop.
- ✔ Anodised aluminium car bodies and track.
- ✔ Torlon® ball bearings.
- ✔ Grade 316 shackle, plunger stop, pivot pin, fasteners and connector plate.

PRODUCT No.	DESCRIPTION	LENGTH mm	WIDTH mm	WEIGHT g	LENGTH in	WIDTH in	WEIGHT oz
Series 22 Safety Rail System							
RCC22-1A	Single car, 1 attachment point, plunger stop, silver	124	58	252	4 7/8	2 5/16	8.9
RCC22-1AB	Single car, 1 attachment point, plunger stop, black	124	58	252	4 7/8	2 5/16	8.9
RCC22-2A	Tandem car, 2 attachment points, plunger stop, silver	254	58	504	10	2 5/16	17.8
RCC22-2AB	Tandem car, 2 attachment points, plunger stop, black	254	58	504	10	2 5/16	17.8
RCC22-3A	Single car, 1 attachment point, silver	124	58	234	4 7/8	2 5/16	8.3
RCC22-3AB	Single car, 1 attachment point, black	124	58	234	4 7/8	2 5/16	8.3
RCC22-5	Connector plate, including screws	-	-	37	-	-	1.3
RC1221J	Track rail joiner	-	-	4	-	-	0.1
RC12281S	Track rail end stop, silver	50	45	50	1 31/32	1 25/32	1.8
RC12281	Track rail end stop, black	50	45	50	1 31/32	1 25/32	1.8
RC1220-3.0S	Track rail, silver, 2996mm	2996	22	1380	117 15/16	7/8	48.7
RC1220-3.0	Track rail, black, 2996mm	2996	22	1380	117 15/16	7/8	48.7
RC12281P	End stop cover plate, including screws, black	-	45	5	-	1 25/32	0.2
RC12281PS	End stop cover plate, including screws, silver	-	45	5	-	1 25/32	0.2



Full installation, usage and maintenance details available under the **SUPPORT** tab at www.ronstan.com.

- ✔ Certified to European Standard EN795:2012 Type D.
- ✔ Low friction.
- ✔ Anti-clatter rubber buffers.
- ✔ Lock up/down track position plunger stop.
- ✔ Suitable for curved track installations with a radius of no less than 2500mm (8'2")
- ✔ Anodised aluminium car bodies and track.
- ✔ Torlon® ball bearings.
- ✔ Grade 316 shackle, plunger stop, pivot pin, fasteners and connector plate.

PRODUCT No.	DESCRIPTION	LENGTH	WIDTH	WEIGHT	LENGTH	WIDTH	WEIGHT
		mm	mm	g	in	in	oz
Series 30 Safety Rail System							
RCC22-4	Connector plate, including screws	-	-	37	-	-	1.3
RCC30-1A	Single car, 1 attachment point, plunger stop, silver	104	77	364	4 1/8	3	12.9
RCC30-1AB	Single car, 1 attachment point, plunger stop, black	104	77	364	4 1/8	3	12.9
RCC30-2A	Tandem car, 2 attachment points, plunger stop, silver	215	77	720	8 1/2	3	25.4
RCC30-2AB	Tandem car, 2 attachment points, plunger stop, black	215	77	720	8 1/2	3	25.4
RCC30-3A	Single car, 1 attachment point, silver	104	77	328	4 1/8	3	11.6
RCC30-3AB	Single car, 1 attachment point, black	104	77	328	4 1/8	3	11.6
RC1301J	Track rail joiner	-	-	10	-	-	0.4
RC13081S	Track rail end stop, silver	58	55	89	2 9/32	2 3/16	3.1
RC13081	Track rail end stop, black	58	55	89	2 9/32	2 3/16	3.1
RC1300-3.0S	Track rail, silver, 2996mm	2996	30	2430	117 15/16	1 3/16	85.7
RC1300-3.0	Track rail, black, 2996mm	2996	30	2430	117 15/16	1 3/16	85.7
RC13081P	End stop cover plate, including screws, black	-	55	16	-	2 3/16	0.6
RC13081PS	End stop cover plate, including screws, silver	-	55	16	-	2 3/16	0.6

SCREW-IN PADEYE SYSTEM DESCRIPTION

The Removable Screw-In Padeye Anchor Device consists of two parts:

- A structural anchor base which is permanently fixed to the structure.
- A screw-in anchor for connection of personal protection equipment.
 - The structural anchor base is to be permanently fastened to the structure using 4 x M6 fasteners.
 - The screw-in anchor is attached to the structural anchor base by means of a central threaded spigot. Once fully threaded in place the anti-rotation locking screw must be engaged to ensure that the anchor cannot unintentionally become detached from the structural anchor base.
 - The screw-in anchor has a single attachment point for personal protection equipment.

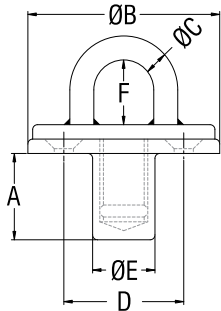
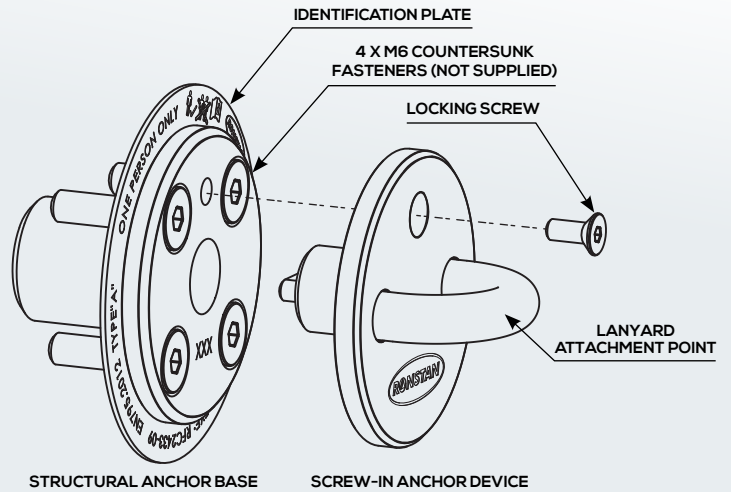

- ✓ Certified to European Standard EN795:2012 Type A and Australian Standards AS1891.4:2009 & AS5532:2013.
- ✓ Screw-in lanyard attachment device can be removed from the base when not in use.
- ✓ Separate locking screw ensures that the screw-in lanyard attachment remains secure when in use.
- ✓ A threaded plug remains in the base when the screw-in anchor device is removed to prevent dirt & grit from entering the threads.
- 🌀 Grade 316 stainless steel throughout for maximum corrosion resistance and longevity.

PRODUCT No.	DESCRIPTION	A mm	B mm	C mm	D mm	E mm	F mm	WEIGHT g
METRIC DIMENSIONS								
Removable Screw-In Padeye Anchor Device								
RFC2433-09	Certified, Screw-In Padeye, 9mm Bar	29.0	70	9.0	26.9	14.0	23.2	303

PRODUCT No.	DESCRIPTION	A in	B in	C in	D in	E in	F in	WEIGHT oz
IMPERIAL DIMENSIONS								
Removable Screw-In Padeye Anchor Device								
RFC2433-09	Certified, Screw-In Padeye, 11/32" Bar	1 5/32	2 3/4	11/32	1 1/16	9/16	29/32	10.7

ANDERSEN WINCHES

248	Winch Selection Guide
249	Features & Information
250	Winch Range Overview
251	Manual Self-Tailing Winches
252	Special Finishes
253 - 255	E1 Electric Winches
256	E2 Electric Winches
257 - 259	Three Speed Electric Winches
261 - 265	Compact Motor™ Variable Speed Electric Winches
266 - 267	Hydraulic Winches
268 - 269	Classic Winches
270 - 272	Winch Handles & Accessories
273	Winch Service Kits





WINCH SELECTION

Choose your Andersen winches to suit the type and size of your yacht and your sailing requirements. This selection guide is intended for masthead rigged monohull yachts of medium displacement. Refer to the notes to the right of this page regarding other rig or displacement types.

Please note that this table lists typical winch sizing for the given applications, but cannot take into account all variables due to the wide variety of sailing vessels and conditions.

For electric or hydraulic winches, the size selection is generally similar to that of a manually operated winch.

For further details see our website at www.andersenwinches.com or consult your local Andersen winches representative for assistance in selecting your winches and information on features, options and installation.

Masthead Rigged

Use the length overall (LOA) figures as your primary selection criteria.

Fractional Rigged

Refer primarily to the sail area rather than LOA.

Heavy Displacement

For boats with heavy displacement and/or a high righting moment, it is advisable to choose a winch larger than those indicated in the table.

Multihulls

Catamarans and trimarans have higher righting moments than monohulls of the same size and should use winches larger than those indicated in the table.

LOA (Metres)	7.6 - 8.5	8.8 - 9.8	10.1 - 10.7	11.0 - 11.9	12.2 - 13.1	13.4 - 14.6	14.9 - 16.5	16.8 - 18.6	18.9 - 21.6	21.9 - 24.4	24.4+
LOA (Feet)	25 - 28	29 - 32	33 - 35	36 - 39	40 - 43	44 - 48	49 - 54	55 - 61	62 - 71	72 - 80	80+
Genoa Sail Area (m ² /ft ²)	28/300	33/3503	44/470	52/560	72/770	82/880	120/1300	170/1800	200/2100	250/2700	-
Spinnaker Sail Area (m ² /ft ²)	38/410	56/600	74/800	111/1200	150/1600	185/2000	260/2800	345/3700	420/4500	500/5400	-
Main Sail Area (m ² /ft ²)	14/150	20/210	24/260	30/320	40/430	46/470	70/750	88/950	102/1100	121/1300	-

APPLICATION	RECOMMENDED WINCH SIZE										
Genoa Sheet	12/16/18	28/34/40	40	46/50	50/52	58/62	62/68	68/72	72/82	82	-
Spinnaker Sheet	10/12	16/18	18/28	28/34/40	40/46	46/50/52	52/58	58/62/68	68/72/82	82	-
Main Sheet	10	12	18/28	18/28	34/40	46/50	52	52/58	58/62/68	68/72	82
Genoa Halyard	10/12	12/18	18/28	34/40	40/46	46/50	52	52/58/62	58/62	72	82
Spinnaker Halyard	10	12	12/18	18/28	40	46	46/50/52	52/58	58/62	68/72	82
Main Halyard	10	12	12/18	28/34/40	40	40/46	46/50/52	52/58	58/62	68/72	82
Reef Line	10	10	10	12/18	18/28	34/40	40/46	46/50/52	52/58	58/62	68



ANDERSEN STAINLESS STEEL WINCHES™

ENDURING STRENGTH, EVERLASTING FINISH

Every Andersen winch is made with the care and craftsmanship that come from more than fifty years of experience. Andersen winches are built to last, to retain their exceptional finish and to deliver season after season of reliable performance and sailing pleasure to their owner through the years.

Materials

Andersen winch drums are produced from grade 316L stainless steel, cold formed in stages during manufacture to further increase strength and hardness as it takes its final form. The resulting construction is lightweight, yet stiff and unyielding.

Drive shafts are in grade 329 duplex stainless steel. Pawls are cut from a cold pressed profile in grade 316 stainless steel and are virtually unbreakable.

The upper centre stems of Andersen winches are manufactured from aluminium bronze for ultimate durability. The combination of materials and design contribute to a lightweight, rigid final assembly that enhances the mechanical efficiency of the winch. Andersen winches are of similar weight to winches with aluminium drums, but are far more durable.

Features













Andersen winch drums incorporate the distinctive Power Rib™ which ensures a controlled grip on the line at all times, whether trimming or easing. The highly polished stainless steel surface minimises vertical friction and allows the loaded rope turns to slide easily upward as the drum rotates, without the shuddering and excessive rope wear seen on winches that rely on a rough surface finish for grip.

Stainless steel roller bearings and ball bearings carry the highest drum loads to the centre stem of the winch, minimising efficiency losses due to friction.

The self-tailing arm can be rotated through 360 degrees for optimum positioning (40ST and larger). Stainless steel self-tailing jaws adjust automatically to suit various rope sizes.

Andersen winches are designed for simple, straightforward installation and maintenance. Servicing is only required every two years or so under normal use.

SELF-TAILING WINCH RANGE

WINCH TYPE	MODEL MANUAL SPEEDS	12ST 1	18ST 1	28ST 2	34ST 2	40ST 2	46ST 2	50ST 2	52ST 2	58ST 2	62ST 2	68ST 2	72ST 2	82ST 3
MANUAL														
Self-Tailing		✓	✓	✓	✓	✓	✓	✓	✓	✓	✓	✓	✓	✓
ELECTRIC*														
E1 Single Speed				✓	✓	✓	✓	✓	✓	✓	✓	✓	✓	✓
E2 Two Speed												✓ 24V only	✓ 24V only	
Three Speed														✓ 24V only
COMPACT MOTOR™ ELECTRIC*1														
Variable Speed Above Deck				✓	✓	✓	✓	✓	✓	✓	✓	✓ *2	✓ *2	✓
Variable Speed Below Deck				✓	✓	✓	✓	✓	✓	✓	✓	✓ *2	✓ *2	✓
HYDRAULIC														
Single Speed									✓	✓	✓	✓	✓	✓
Three Speed														✓
ELECTRIC CONVERSION KIT*1														
E1 Single Speed				✓	✓	✓	✓	✓	✓	✓	✓	✓	✓	✓
E2 Two Speed												✓ 24V only	✓ 24V only	
Compact Motor™ Variable Speed Above Deck				✓	✓	✓	✓	✓	✓	✓	✓	✓ *2	✓ *2	✓
Compact Motor™ Variable Speed Below Deck				✓	✓	✓	✓	✓	✓	✓	✓	✓ *2	✓ *2	✓

*1 Available in 12V or 24V unless specified otherwise.

*2 Sizes 68ST & 72ST Compact Motor™ electric winches have low range and high range variable speed control, via the two included push buttons.

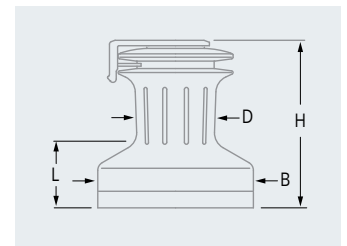

PRODUCT No.	WINCH MODEL	GEAR RATIO 1ST SPEED	GEAR RATIO 2ND SPEED	GEAR RATIO 3RD SPEED	POWER RATIO 1ST SPEED	POWER RATIO 2ND SPEED	POWER RATIO 3RD SPEED	LINE SIZE mm	DRUM "D" mm	BASE "B" mm	HEIGHT "H" mm	LINE ENTRY "L" mm	WEIGHT kg
RA2012010000	12ST	1.3:1	-	-	9.5:1	-	-	8-14	70	115	128	44	2.6
RA2018010000	18ST	2.6:1	-	-	18.8:1	-	-	8-14	70	120	135	50	3.2
RA2028010000	28ST	1.3:1	4.0:1	-	9.5:1	28.6:1	-	8-14	70	125	149	65	3.9
RA2034010000	34ST	1.3:1	4.7:1	-	9.5:1	33.8:1	-	8-14	70	125	149	65	4.1
RA2040010000	40ST	1.3:1	6.0:1	-	8.9:1	40.0:1	-	8-14	75	152	174	71	4.9
RA2046010000	46ST	2.8:1	8.4:1	-	15.7:1	47.1:1	-	8-14	89	180	204	90	7.8
RA2050010000	50ST	2.8:1	8.8:1	-	15.7:1	49.3:1	-	8-14	89	180	204	90	7.8
RA2052010000	52ST	3.2:1	10.5:1	-	16.2:1	52.5:1	-	8-16	100	200	222	106	10.3
RA2058010000	58ST	3.7:1	13.1:1	-	16.0:1	57.1:1	-	8-18	115	230	251	111	16.0
RA2062010000	62ST	3.7:1	14.4:1	-	16.0:1	62.6:1	-	8-18	115	230	251	111	16.0
RA2068010000	68ST	5.8:1	18.8:1	-	20.7:1	67.1:1	-	10-18	140	280	275	120	24.5
RA2072010000	72ST	5.8:1	20.3:1	-	20.7:1	72.6:1	-	10-18	140	280	275	120	24.5
RA2082010000	82-3ST	3.7:1	8.8:1	27.7:1	11.0:1	26.0:1	81.6:1	12-18	170	318	305	127	28.9

METRIC DIMENSIONS

PRODUCT No.	WINCH MODEL	GEAR RATIO 1ST SPEED	GEAR RATIO 2ND SPEED	GEAR RATIO 3RD SPEED	POWER RATIO 1ST SPEED	POWER RATIO 2ND SPEED	POWER RATIO 3RD SPEED	LINE SIZE in	DRUM "D" in	BASE "B" in	HEIGHT "H" in	LINE ENTRY "L" in	WEIGHT lb
RA2012010000	12ST	1.3:1	-	-	9.5:1	-	-	5/16-9/16	2 3/4	4 1/2	5 1/16	1 3/4	5.7
RA2018010000	18ST	2.6:1	-	-	18.8:1	-	-	5/16-9/16	2 3/4	4 3/4	5 5/16	1 15/16	7.0
RA2028010000	28ST	1.3:1	4.0:1	-	9.5:1	28.6:1	-	5/16-9/16	2 3/4	4 15/16	5 7/8	2 9/16	8.6
RA2034010000	34ST	1.3:1	4.7:1	-	9.5:1	33.8:1	-	5/16-9/16	2 3/4	4 15/16	5 7/8	2 9/16	9.0
RA2040010000	40ST	1.3:1	6.0:1	-	8.9:1	40.0:1	-	5/16-9/16	2 15/16	6	6 7/8	2 13/16	10.8
RA2046010000	46ST	2.8:1	8.4:1	-	15.7:1	47.1:1	-	5/16-9/16	3 1/2	7 1/16	8	3 9/16	17.2
RA2050010000	50ST	2.8:1	8.8:1	-	15.7:1	49.3:1	-	5/16-9/16	3 1/2	7 1/16	8	3 9/16	17.2
RA2052010000	52ST	3.2:1	10.5:1	-	16.2:1	52.5:1	-	5/16-5/8	3 15/16	7 7/8	8 3/4	4 3/16	22.7
RA2058010000	58ST	3.7:1	13.1:1	-	16.0:1	57.1:1	-	5/16-5/8	4 1/2	9 1/16	9 7/8	4 3/8	35.3
RA2062010000	62ST	3.7:1	14.4:1	-	16.0:1	62.6:1	-	5/16-5/8	4 1/2	9 1/16	9 7/8	4 3/8	35.3
RA2068010000	68ST	5.8:1	18.8:1	-	20.7:1	67.1:1	-	3/8-5/8	5 1/2	11	10 3/16	4 3/4	54.0
RA2072010000	72ST	5.8:1	20.3:1	-	20.7:1	72.6:1	-	3/8-5/8	5 1/2	11	10 3/16	4 3/4	54.0
RA2082010000	82-3ST	3.7:1	8.8:1	27.7:1	11.0:1	26.0:1	81.6:1	1/2-3/4	6 11/16	12 1/2	12	5	63.6

IMPERIAL DIMENSIONS



© Onne Van Der Wal

SPECIAL FINISHES

Hand polished stainless steel has long been the signature finish for Andersen winches. They are also available in a selection of other high quality special finishes:

PVD COATING

An extremely durable coating process known as Physical Vapour Deposition that can be used to apply a black or bronze coloured finish to the stainless steel components of our winches. It is a high quality, permanent finish with excellent impact and abrasion resistance.

ZT FINISH

A surface finish for stainless steel obtained by hand polishing the surface, and then blasting the metal with a finishing media. The ZT finish is often described as "gun metal grey" or "titanium look".





E1 ELECTRIC WINCHES

EMPOWERED SAILING

Andersen E1 electric winches allow you to hoist and trim sails at the push of a button regardless of physical strength, so any crew member can easily and safely trim sails and control lines. Perfect for enjoying sailing short-handed or with friends and family. In addition to the host of standard features that make Andersen self-tailing winches the benchmark for quality and performance, Andersen E1 electric winches are engineered with unsurpassed levels of functionality, monitoring and protection.

Ease of installation

Contactors and controller are contained within the motor unit, so no separate control box is necessary. Simplified electrical installation requires just the connection of positive and negative power cables to the motor terminals and the connection of the push button using the included output cable. Marine grade circuit breakers are also available for protection and isolation.

Efficient, high quality motor

At the heart of the E1 electric winch is a high quality European engineered and manufactured series wound motor. Carefully matched with the optimum gearbox these winches deliver high speed at low load for fast sheeting in, and low speed at high load for safe, fine tuning when trimming. They are available in 12 volt and 24 volt models providing smooth and quiet operation across a wide working load range.

Illuminated "intelligent" push button

E1 winches are supplied with a push button with an integrated LED which illuminates when power to the winch system is on. The push button incorporates a hinged safety cover to prevent inadvertent winch operation and is water resistant rated to IP67. The push button also acts with the controller to flash status codes that assist with troubleshooting in the event of overload or where other system protection intervention occurs. A cable for connection of the push button is included for convenient installation.

Unrivalled monitoring and protection

Integrated overload protection – The controller is pre-set to stop the winch if the maximum pull load is exceeded. Operation can resume within a few seconds when the load returns below the limit.

Thermal overload protection – The motor is fitted with a thermal cutout that disables the motor in case of overheating; it automatically resets after the temperature returns to normal.

Reverse polarity protection – An integrated 5 amp fuse protects the motor against incorrect cable connection.

Accidental start protection – Winch operation is disabled if the push button is already inadvertently pressed when the power supply is turned on at the circuit breaker or battery.

Low voltage detection – Operation is disabled if the battery charge level is low, which prevents further drain on batteries and avoids triggering low voltage reset of navigation instruments and other electronic devices.

Continuous run time limit – Operation is disabled if continuous run time exceeds 10 minutes.

Manual operation

Two speed manual operation is always available as a backup.



Included with all E1 electric winches and conversion kits:

- 1 x RA582000 push button
- 1200mm (47") input/output cable from the motor



E1 electric motor conversion kits also available

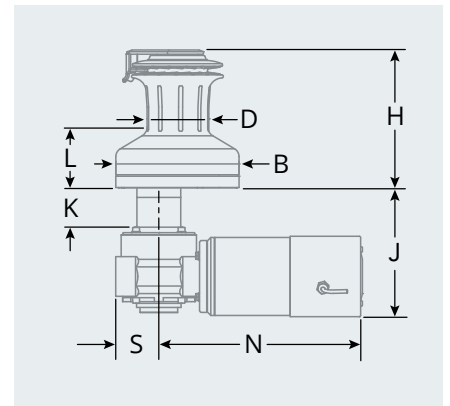

For full technical and installation details, refer to Winch Data Sheets and User Manuals available on www.andersenwinches.com

WINCH MODEL	LINE SIZE mm	DRUM "D" mm	BASE "B" mm	HEIGHT "H" mm	LINE ENTRY "L" mm	MAX. DECK "K" mm*	MOTOR DEPTH "J" mm	GEAR LENGTH "S" mm	MOTOR LENGTH "N" mm	WEIGHT kg
28ST	8 - 14	70	125	157	75	49	183	65	300	18
34ST	8 - 14	70	125	157	75	49	183	65	300	18
40ST	8 - 14	75	152	182	79	49	183	65	300	19
46ST	8 - 14	89	181	204	90	57	191	65	300	21
50ST	8 - 14	89	181	204	90	57	191	65	300	21
52ST	8 - 16	100	200	222	106	57	196	65	350	28
58ST	8 - 18	115	230	261	122	41	213	75	384	35
62ST	8 - 18	115	230	261	122	41	213	75	384	35
68ST	10 - 18	140	280	285	130	41	213	75	384	42
72ST	10 - 18	140	280	285	130	41	213	75	384	42

WINCH MODEL	LINE SIZE in	DRUM "D" in	BASE "B" in	HEIGHT "H" in	LINE ENTRY "L" in	MAX. DECK "K" in*	MOTOR DEPTH "J" in	GEAR LENGTH "S" in	MOTOR LENGTH "N" in	WEIGHT lb
28ST	5/16 - 9/16	2 3/4	4 15/16	6 3/16	2 15/16	1 15/16	7 3/16	2 9/16	11 13/16	39.7
34ST	5/16 - 9/16	2 3/4	4 15/16	6 3/16	2 15/16	1 15/16	7 3/16	2 9/16	11 13/16	39.7
40ST	5/16 - 9/16	2 15/16	6	7 3/16	3 1/8	1 15/16	7 3/16	2 9/16	11 13/16	41.9
46ST	5/16 - 9/16	3 1/2	7 1/8	8	3 9/16	2 1/4	7 1/2	2 9/16	11 13/16	46.3
50ST	5/16 - 9/16	3 1/2	7 1/8	8	3 9/16	2 1/4	7 1/2	2 9/16	11 13/16	46.3
52ST	5/16 - 5/8	3 15/16	7 7/8	8 3/4	4 3/16	2 1/4	7 1/2	2 9/16	13 13/16	61.7
58ST	5/16 - 5/8	4 1/2	9 1/16	10 1/4	4 13/16	1 5/8	8 3/8	2 15/16	15 1/8	77.1
62ST	5/16 - 5/8	4 1/2	9 1/16	10 1/4	4 13/16	1 5/8	8 3/8	2 15/16	15 1/8	77.1
68ST	13/32 - 5/8	5 1/2	11	11 1/4	5 1/8	1 5/8	8 3/8	2 15/16	15 1/8	92.6
72ST	13/32 - 5/8	5 1/2	11	11 1/4	5 1/8	1 5/8	8 3/8	2 15/16	15 1/8	92.6

*Extensions available to suit longer "K" dimensions.

WINCHES & CONVERSION KITS



WINCH MODEL	E1 FULL STAINLESS WINCHES		E1 WINCH CONVERSION KITS	
	12V	24V	12V	24V
Winches & Conversion Kits				
28ST	RA2028011300	RA2028011400	RA2028211300	RA2028211400
34ST	RA2034011300	RA2034011400	RA2034211300	RA2034211400
40ST	RA2040011300	RA2040011400	RA2040211300	RA2040211400
46ST	RA2046011300	RA2046011400	RA2046211300	RA2046211400
50ST	RA2050011300	RA2050011400	RA2050211300	RA2050211400
52ST	RA2052011300	RA2052011400	RA2052211300	RA2052211400
58ST	RA2058011300	RA2058011400	RA2058211300	RA2058211400
62ST	RA2062011300	RA2062011400	RA2062211300	RA2062211400
68ST	RA2068011300	RA2068011400	RA2068211300	RA2068211400
72ST	RA2072011300	RA2072011400	RA2072211300	RA2072211400

PUSH BUTTONS



PRODUCT No.	DESCRIPTION
Push Buttons	
RA582000	Push button on/off switch, LED, plastic hinged cover, incl. 500mm (19 5/8") cable with connectors
RA582010	Push button on/off switch, LED, stainless steel hinged cover, incl. 500mm (19 5/8") cable with connectors
RA582020	Push button on/off switch, LED, stainless steel hinged cover with finger access, incl. 500mm (19 5/8") cable with connectors

☑ Rubber gasket included.

☑ Requires only 25mm (1") clearance below mounting surface.

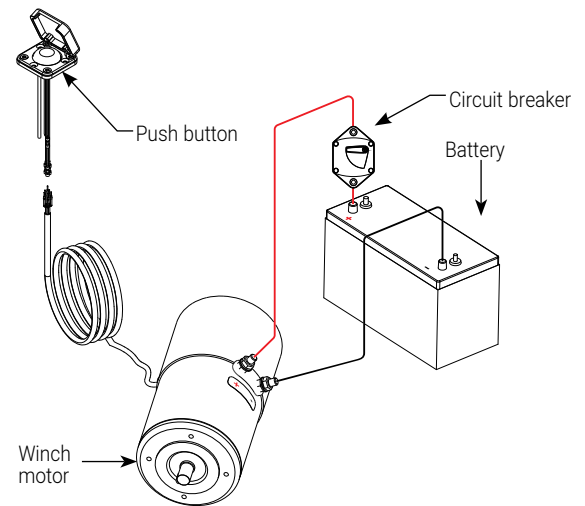

CIRCUIT BREAKERS

PRODUCT NO.	DESCRIPTION	COMPATIBLE WINCH SIZES
Circuit Breakers		
RA590070	Circuit breaker 70 amp	For full technical and installation details, refer to Winch Data Sheets and User Manuals available on www.andersenwinches.com
RA590120	Circuit breaker 120 amp	
RA590150	Circuit breaker 150 amp	
RA590200	Circuit breaker 200 amp	



- ☑ "Slow blow" type, manual reset
- ☑ On/Off switch capability
- ☑ External ignition protected (ABYC E-11; CE; SAE J1171)
- ☑ Marine weatherproof rated
- ☑ DC power systems only
- ☑ 8mm (5/16") cable terminals (same as E1 motor unit)



TWO SPEED ELECTRIC

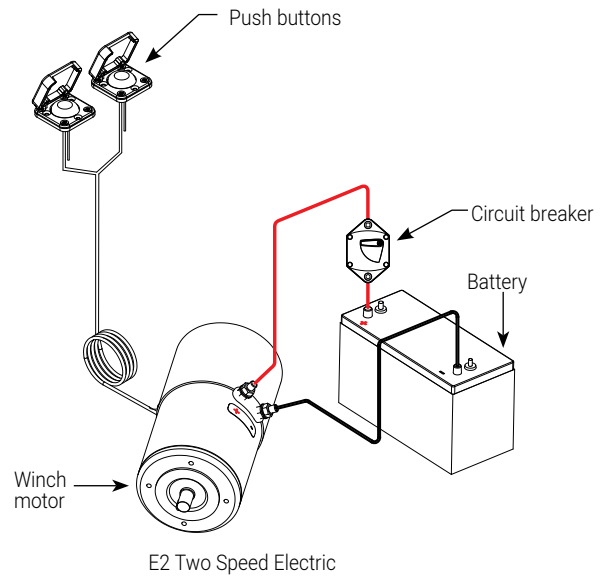

PRODUCT No.	DESCRIPTION
E2 Two Speed Electric	
RA2068011800	68ST winch, two speed electric 24V
RA2072011800	72ST winch, two speed electric 24V
RA2068211800	E2 electric conversion kit 24V, to suit 68ST
RA2072211800	E2 electric conversion kit 24V, to suit 72ST



Included with E2 electric winches and conversion kits:
 • 2 x RA582000 push buttons
 • 1200mm (47") input/output cable from the motor



E2 electric motor conversion kits also available

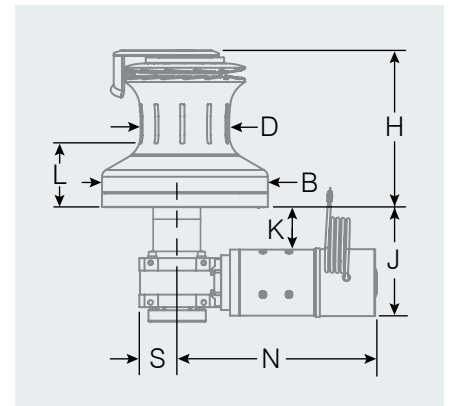

For full technical and installation details, refer to Winch Data Sheets and User Manuals available on www.andersenwinches.com

WINCH MODEL	LINE SIZE mm	DRUM "D" mm	BASE "B" mm	HEIGHT "H" mm	LINE ENTRY "L" mm	MAX. DECK "K" mm*	MOTOR DEPTH "J" mm	GEAR LENGTH "S" mm	MOTOR LENGTH "N" mm	WEIGHT kg
METRIC DIMENSIONS										
68ST	10 - 18	140	280	285	130	75	240	73	382	43.1
72ST	10 - 18	140	280	285	130	75	240	73	382	43.1

WINCH MODEL	LINE SIZE in	DRUM "D" in	BASE "B" in	HEIGHT "H" in	LINE ENTRY "L" in	MAX. DECK "K" in*	MOTOR DEPTH "J" in	GEAR LENGTH "S" in	MOTOR LENGTH "N" in	WEIGHT lb
IMPERIAL DIMENSIONS										
68ST	3/8 - 5/8	5 1/2	11	11 7/32	5 1/8	2 15/16	9 7/16	2 7/8	15	95
72ST	3/8 - 5/8	5 1/2	11	11 7/32	5 1/8	2 15/16	9 7/16	2 7/8	15	95

*Extensions available to suit longer "K" dimensions.



THREE SPEED ELECTRIC WINCHES

EMPOWERED SAILING

Andersen Three Speed electric winches are the perfect solution for larger boats, of 16m (60ft) or more, providing the power and control to safely hoist and trim sails of any size at the push of a button.

In addition to the host of standard features that make Andersen self-tailing winches the benchmark for quality and performance, Andersen Three Speed electric winches are engineered with unsurpassed levels of performance, monitoring and protection.

Powerful and efficient, high quality motor

At the heart of each Andersen Three Speed electric winch is a powerful European engineered and manufactured series wound motor. Carefully matched with the optimum gearbox these winches deliver high speed at low load for fast sheeting in, and low speed at high load for safe, fine tuning when trimming. For maximum performance and efficiency they are supplied in a 24 volt version, providing smooth operation across a wide working load range.

Illuminated "intelligent" push buttons

Three Speed electric winches are supplied with push buttons with integrated LED which illuminates when power to the winch system is on. The push buttons incorporate a hinged safety cover to prevent inadvertent winch operation and are water resistant rated to IP67. The push buttons also act with the controller to flash status codes that assist with trouble shooting in the event of overload or where other system protection intervention occurs.

Manual operation

Manual operation is always available as a backup.

Unrivalled monitoring and protection

Integrated overload protection – The controller is pre-set to stop the winch if the maximum pull load is exceeded. Operation can resume within a few seconds when the load returns below the limit.

Thermal overload protection – The motor is fitted with a thermal cutout that disables the motor in case of overheating; it automatically resets after the temperature returns to normal.

Reverse polarity protection – An integrated 5 amp fuse protects the controller against incorrect cable connection.

Accidental start protection – Winch operation is disabled if a push button is already inadvertently pressed when the power supply is turned on at the circuit breaker or battery.

Low voltage detection – Operation is disabled if the battery charge level is low, which prevents further drain on batteries and avoids triggering low voltage reset of navigation instruments and other electronic devices.

Continuous run time limit – Operation is disabled if continuous run time exceeds 10 minutes.



THREE SPEED ELECTRIC

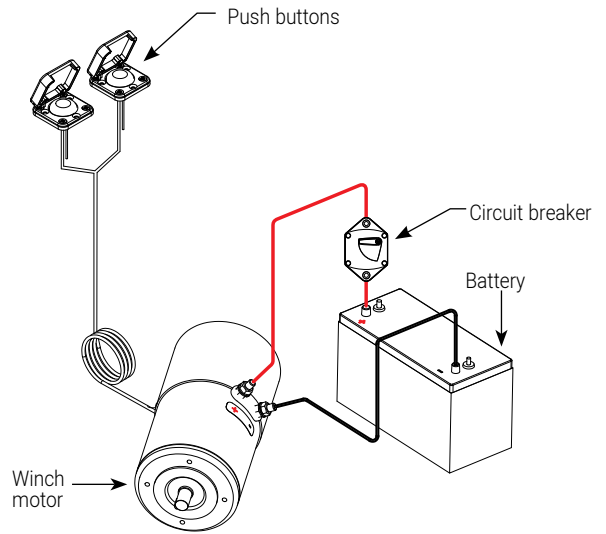

82-3ST Three Speed Electric

PRODUCT No.	DESCRIPTION
Three Speed Electric Winches	
RA2082012200	82-3ST winch, three speed electric 24V



Included with 82-3ST Three Speed electric winch:
 • 2 x RA582000 push buttons
 • 1200mm (47") input/output cable from the motor

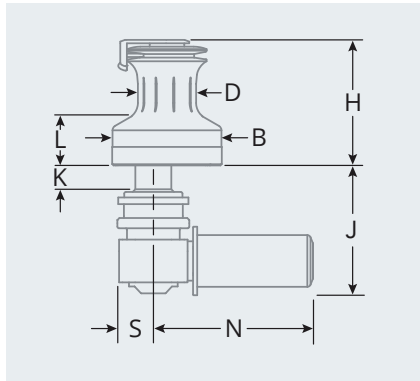

For full technical and installation details, refer to Winch Data Sheets and User Manuals available on www.andersenwinches.com

WINCH MODEL	LINE SIZE mm	DRUM "D" mm	BASE "B" mm	HEIGHT "H" mm	LINE ENTRY "L" mm	MAX. DECK "K" mm*	MOTOR DEPTH "J" mm	GEAR LENGTH "S" mm	MOTOR LENGTH "N" mm	WEIGHT kg
82-3ST	12 - 18	170	318	305	127	106	247	73	382	49.5

METRIC DIMENSIONS

WINCH MODEL	LINE SIZE in	DRUM "D" in	BASE "B" in	HEIGHT "H" in	LINE ENTRY "L" in	MAX. DECK "K" in*	MOTOR DEPTH "J" in	GEAR LENGTH "S" in	MOTOR LENGTH "N" in	WEIGHT lb
82-3ST	1/2 - 3/4	6 11/16	12 1/2	12	5	4 3/16	9 3/4	2 7/8	15 1/16	108.9

IMPERIAL DIMENSIONS

* Extensions available to suit longer "K" dimensions.



© X-Yachts

PUSH BUTTONS



- ✔ Rubber gasket included.
- ✔ Push button requires only 25mm (1") clearance below mounting surface

PRODUCT No.	DESCRIPTION
Push Buttons	
RA582000	Push button on/off switch, LED, plastic hinged cover, incl. 500mm (19 5/8") cable with connectors
RA582010	Push button on/off switch, LED, stainless steel hinged cover, incl. 500mm (19 5/8") cable with connectors
RA582020	Push button on/off switch, LED, stainless steel hinged cover with finger hole, incl. 500mm (19 5/8") cable with connectors

CIRCUIT BREAKER

PRODUCT NO.	DESCRIPTION	COMPATIBLE WINCH SIZES
Circuit Breaker		
RA590150	Circuit breaker 150 amp	For full technical and installation details, refer to Winch Data Sheets and User Manuals available on www.andersenwinches.com



- ✔ "Slow blow" type, manual reset
- ✔ On/Off switch capability
- ✔ External ignition protected (ABYC E-11; CE; SAE J1171)
- ✔ Marine weatherproof rated
- ✔ DC power systems only
- ✔ 8mm (5/16") cable terminals





EMPOWERED SAILING

EMPOWERED SAILING

Andersen Compact Motor™ electric winches allow you to hoist and trim sails at the push of a button regardless of physical strength, so any crew member can easily and safely trim sails and control lines.

Ease of installation

The Andersen Compact Motor™ electric winch is available in two formats for either Above Deck or Below Deck motor placement. Motor gearbox and controller are integrated into one compact unit with no extra control box necessary. Simplified electrical installation requires just the connection of positive and negative power cables to the motor terminals and the connection of the push button using the included output cable.

Efficient, variable speed

The Andersen Compact Motor™ is a brushless DC motor carefully matched to a low profile planetary gearbox which requires less space for installation and draws considerably less current than traditional motor/gearbox configurations. Available in 12 volt and 24 volt models, Compact Motor™ electric winches operate at variable speed in proportion to the pressure applied to the push button for smooth and quiet operation.

Illuminated "intelligent" push button

Compact Motor™ winches are supplied with a push button with integrated LED which illuminates when power is applied to the system. The push button incorporates a hinged safety cover to prevent inadvertent winch operation and is water resistant rated to IP67. The push button also acts with the controller to assist with trouble shooting, by flashing in the event of overload or where other system protection intervention occurs. A cable for connection of the push button is included for convenient installation.

Built-in protection

Integrated overload protection – The controller is pre-set to stop the winch if the maximum pull load is exceeded. Operation can resume within a few seconds when the load returns below the limit.

Thermal overload protection – The motor is fitted with a thermal cutout that disables the motor in case of overheating; it automatically resets after the temperature returns to normal.

Manual operation

Two speed manual operation is always available as a backup; to winch beyond the pre-set maximum pull load (but below the winch MWL) or just for the experience.



Above Deck Compact Motor™ unit

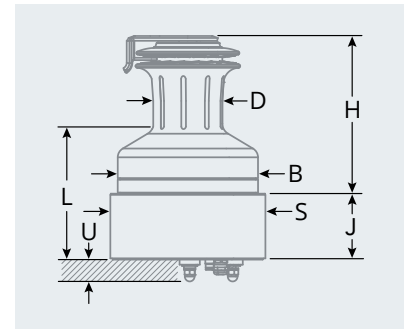

- Included with all above deck Compact Motor™ electric winches:
- 1*2 x RA866000 push button with 190mm (7 1/2") control cable
 - 1*2 x RD877610 1m (39") control cable
 - 1 x 877800 terminal extension kit
 - 1 x 877750 circuit breaker with integrated controller
 - Motor has 140mm (5 1/2") control cable included
 - Drain tube
 - Lip seal service kit.

For full technical and installation details, refer to Winch Data Sheets and User Manuals available on www.andersenwinches.com

WINCH MODEL	LINE SIZE mm	DRUM "D" mm	BASE "B" mm	HEIGHT "H" mm	LINE ENTRY "L" mm	MOTOR HEIGHT "J" mm	MOTOR DIAM. "S" mm	MOTOR DEPTH "U" mm ¹	WEIGHT kg
METRIC DIMENSIONS									
28ST	8 - 14	70	125	149	150	85	200	28	16
34ST	8 - 14	70	125	149	150	85	200	28	16
40ST	8 - 14	75	152	174	156	85	200	28	17
46ST	8 - 14	89	181	204	175	85	200	28	19
50ST	8 - 14	89	181	204	175	85	200	28	19
52ST	8 - 16	100	200	222	191	85	254	28	29
58ST	8 - 18	115	230	251	196	85	254	28	34
62ST	8 - 18	115	230	251	196	85	254	28	34
68ST	10 - 18	140	280	275	209	89	285	27	51
72ST	10 - 18	140	280	275	209	89	285	27	51

WINCH MODEL	LINE SIZE in	DRUM "D" in	BASE "B" in	HEIGHT "H" in	LINE ENTRY "L" in	MOTOR HEIGHT "J" in	MOTOR DIAM. "S" in	MOTOR DEPTH "U" in ¹	WEIGHT lb
IMPERIAL DIMENSIONS									
28ST	5/16 - 9/16	2 3/4	4 15/16	5 7/8	5 15/16	3 3/8	7 7/8	1 1/8	35.3
34ST	5/16 - 9/16	2 3/4	4 15/16	5 7/8	5 15/16	3 3/8	7 7/8	1 1/8	35.3
40ST	5/16 - 9/16	2 15/16	6	6 7/8	6 1/8	3 3/8	7 7/8	1 1/8	37.5
46ST	5/16 - 9/16	3 1/2	7 1/8	8	6 7/8	3 3/8	7 7/8	1 1/8	41.9
50ST	5/16 - 9/16	3 1/2	7 1/8	8	6 7/8	3 3/8	7 7/8	1 1/8	41.9
52ST	5/16 - 5/8	3 15/16	7 7/8	8 3/4	7 1/2	3 3/8	10	1 1/8	63.9
58ST	5/16 - 5/8	4 1/2	9 1/16	9 7/8	7 3/4	3 3/8	10	1 1/8	75
62ST	5/16 - 5/8	4 1/2	9 1/16	9 7/8	7 3/4	3 3/8	10	1 1/8	75
68ST	13/32 - 5/8	5 1/2	11	10 3/16	8 1/4	3 1/2	11 1/4	1 1/16	112.5
72ST	13/32 - 5/8	5 1/2	11	10 3/16	8 1/4	3 1/2	11 1/4	1 1/16	112.5

*1 All Compact Motor™ Above Deck winches are supplied with 1 set of 41mm (1 5/8") terminal extensions. Additional 877800 terminal extension kits available to order to suit longer "U" dimensions.

*2 Sizes 68ST & 72ST Compact Motor™ electric winches are supplied with 2 x RA866000 control buttons and 2 x RD877610 1m (39") control cables.

WINCHES & CONVERSION KITS



WINCH MODEL	COMPACT MOTOR™ ABOVE DECK FULL STAINLESS WINCHES		COMPACT MOTOR™ ABOVE DECK WINCH CONVERSION KITS	
	12V	24V	12V	24V
Winches & Conversion Kits				
28ST	RA2028015100	RA2028015200	RA2028215100	RA2028215200
34ST	RA2034015100	RA2034015200	RA2034215100	RA2034215200
40ST	RA2040015100	RA2040015200	RA2040215100	RA2040215200
46ST	RA2046015100	RA2046015200	RA2046215100	RA2046215200
50ST	RA2050015100	RA2050015200	RA2050215100	RA2050215200
52ST	RA2052015100	RA2052015200	RA2052215100	RA2052215200
58ST	RA2058015100	RA2058015200	RA2058215100	RA2058215200
62ST	RA2062015100	RA2062015200	RA2062215100	RA2062215200
68ST	RA2068015100	RA2068015200	RA2068215100	RA2068215200
72ST	RA2072015100	RA2072015200	RA2072215100	RA2072215200

PUSH BUTTONS & ACCESSORIES



PRODUCT No.	DESCRIPTION
Push Buttons	
RA866000	Push button, proportional switch, LED, plastic hinged cover, incl. 190mm (7 1/2") cable with connectors
RA866010	Push button, proportional switch, LED, stainless steel hinged cover, incl. 190mm (7 1/2") cable with connectors
RA866020	Push button, proportional switch, LED, stainless steel hinged cover with finger access, incl. 190mm (7 1/2") cable with connectors

✓ Rubber gasket included.

✓ Requires only 25mm (1") clearance below mounting surface.

PRODUCT No.	DESCRIPTION
Control Cables	
RD877610	Compact Motor™ control cable 1000mm (39") long
RD877611	Compact Motor™ control cable 4000mm (157") long
Power Terminal Extensions	
877800	Compact Motor™ power terminal extension set (1 x Red & 1 x Black) 41mm (1 5/8") long, M8
Circuit Breaker	
877750	Circuit breaker with integrated controller

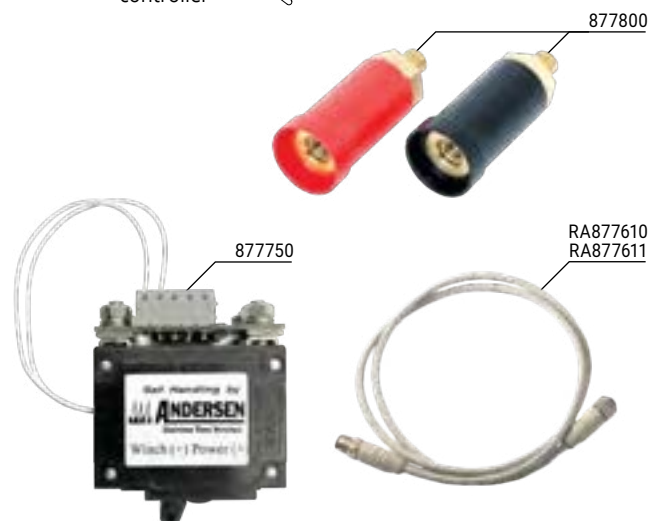
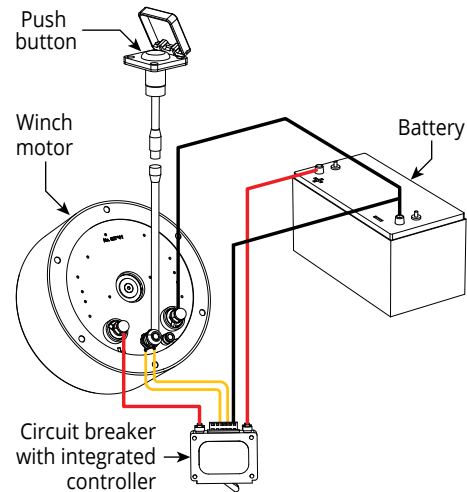



- Included with all below deck Compact Motor™ electric winches:
- 1*2 x RA866000 push button with 190mm (7 1/2") control cable
 - 1*2 x RD877610 1m (39") control cable
 - 1 x 877750 circuit breaker with integrated controller
 - Motor has 140mm (5 1/2") control cable included
 - Drain tube
 - Lip seal service kit.



Below Deck Compact Motor™ unit

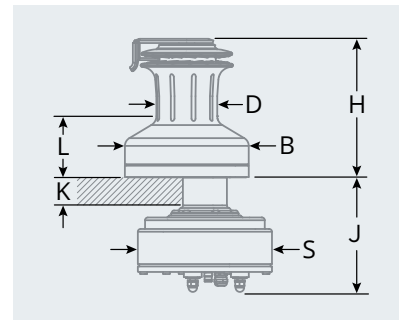

For full technical and installation details, refer to Winch Data Sheets and User Manuals available on www.andersenwinches.com

WINCH MODEL	LINE SIZE mm	DRUM "D" mm	BASE "B" mm	HEIGHT "H" mm	LINE ENTRY "L" mm	MAX. DECK "K" mm ¹	MOTOR HEIGHT "J" mm	MOTOR DIAM. "S" mm	WEIGHT kg
28ST	8 - 14	70	125	157	75	50	173	195	17
34ST	8 - 14	70	125	157	75	50	173	195	17
40ST	8 - 14	75	152	182	79	50	173	195	18
46ST	8 - 14	89	181	204	90	57	182	195	21
50ST	8 - 14	89	181	204	90	57	182	195	21
52ST	8 - 16	100	200	222	106	56	179	250	30
58ST	8 - 18	115	230	261	122	44	168	250	36
62ST	8 - 18	115	230	261	122	44	168	250	36
68ST	10 - 18	140	280	285	130	47	171	250	45
72ST	10 - 18	140	280	285	130	47	171	250	45

WINCH MODEL	LINE SIZE in	DRUM "D" in	BASE "B" in	HEIGHT "H" in	LINE ENTRY "L" in	MAX. DECK "K" in ¹	MOTOR HEIGHT "J" in	MOTOR DIAM. "S" in	WEIGHT lb
28ST	5/16 - 9/16	2 3/4	4 15/16	6 3/16	2 15/16	2	6 13/16	7 11/16	37.5
34ST	5/16 - 9/16	2 3/4	4 15/16	6 3/16	2 15/16	2	6 13/16	7 11/16	37.5
40ST	5/16 - 9/16	2 15/16	6	7 3/16	3 1/8	2	6 13/16	7 11/16	39.7
46ST	5/16 - 9/16	3 1/2	7 1/8	8	3 9/16	2 1/4	7 3/16	7 11/16	46.3
50ST	5/16 - 9/16	3 1/2	7 1/8	8	3 9/16	2 1/4	7 3/16	7 11/16	46.3
52ST	5/16 - 5/8	3 15/16	7 7/8	8 3/4	4 3/16	2 3/16	7 1/16	9 7/8	66.2
58ST	5/16 - 5/8	4 1/2	9 1/16	10 1/4	4 13/16	1 3/4	6 5/8	9 7/8	79.4
62ST	5/16 - 5/8	4 1/2	9 1/16	10 1/4	4 13/16	1 3/4	6 5/8	9 7/8	79.4
68ST	13/32 - 5/8	5 1/2	11	11 1/4	5 1/8	1 7/8	6 3/4	9 7/8	99.2
72ST	13/32 - 5/8	5 1/2	11	11 1/4	5 1/8	1 7/8	6 3/4	9 7/8	99.2

*1 Extensions available to suit longer "K" dimensions.

*2 Sizes 68ST & 72ST Compact Motor™ electric winches are supplied with 2 x RA866000 control buttons and 2 x RD877610 1m (39") control cables.

WINCHES & CONVERSION KITS



WINCH MODEL	COMPACT MOTOR™ BELOW DECK FULL STAINLESS WINCHES		COMPACT MOTOR™ BELOW DECK WINCH CONVERSION KITS	
	12V	24V	12V	24V
Winches & Conversion Kits				
28ST	RA2028014100	RA2028014200	RA2028214100	RA2028214200
34ST	RA2034014100	RA2034014200	RA2034214100	RA2034214200
40ST	RA2040014100	RA2040014200	RA2040214100	RA2040214200
46ST	RA2046014100	RA2046014200	RA2046214100	RA2046214200
50ST	RA2050014100	RA2050014200	RA2050214100	RA2050214200
52ST	RA2052014100	RA2052014200	RA2052214100	RA2052214200
58ST	RA2058014100	RA2058014200	RA2058214100	RA2058214200
62ST	RA2062014100	RA2062014200	RA2062214100	RA2062214200
68ST	RA2068014100	RA2068014200	RA2068214100	RA2068214200
72ST	RA2072014100	RA2072014200	RA2072214100	RA2072214200

PUSH BUTTONS & ACCESSORIES



PRODUCT No.	DESCRIPTION
Push Buttons	
RA866000	Push button on/off switch, LED lit, plastic hinged cover, incl. 190mm (7 1/2") cable with connectors
RA866010	Push button on/off switch, LED lit, stainless steel hinged cover, incl. 190mm (7 1/2") cable with connectors

- ✔ Rubber gasket included.
- ✔ Requires only 25mm (1") clearance below mounting surface.

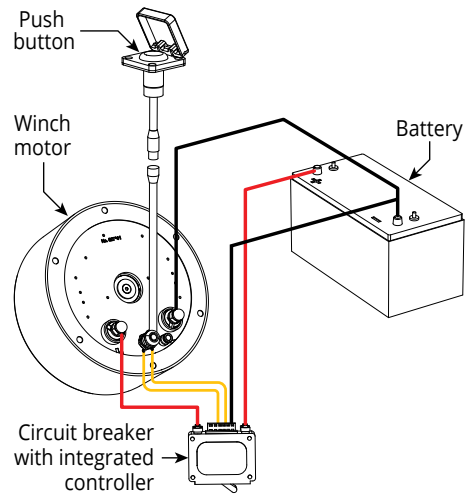

PRODUCT No.	DESCRIPTION
Control Cables	
RD877610	Compact Motor™ control cable 1000mm (39") long
RD877611	Compact Motor™ control cable 4000mm (157") long
Circuit Breaker	
877750	Circuit breaker with integrated controller

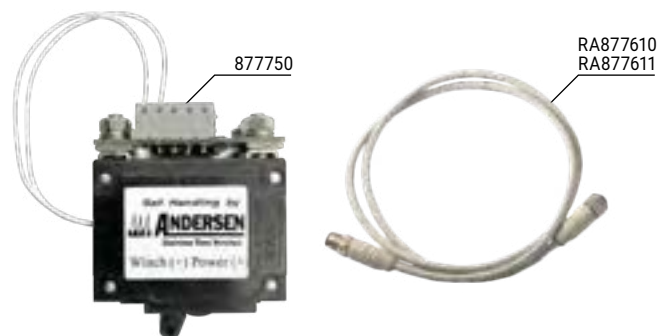



EMPOWERED SAILING

ANDERSEN hydraulic winches can be powered by an appropriately configured power pack which may already be installed on board for various other equipment such as a furler or anchor windlass.

Fitted with industry-standard hydraulic motors, our hydraulic winches are compatible with most common types of hydraulic systems found on board today's larger yachts.

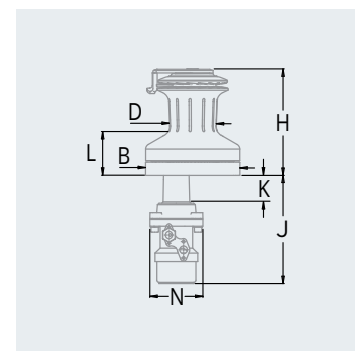

PRODUCT No.	WINCH MODEL	LINE SIZE mm	DRUM "D" mm	BASE "B" mm	HEIGHT "H" mm	LINE ENTRY "L" mm	MAX. DECK "K" mm*1	MOTOR DEPTH "J" mm	MOTOR WIDTH "N" mm	WEIGHT kg
RA2052013100	52ST	8 - 16	100	200	220	116	54	246	130	23
RA2058013100	58ST	8 - 18	115	230	251	121	54	252	130	30
RA2062013100	62ST	8 - 18	115	230	251	121	54	252	130	30
RA2068013100	68ST	10 - 18	140	280	273	130	60	232	130	41
RA2072013100	72ST	10 - 18	140	280	273	130	60	232	130	41

PRODUCT No.	WINCH MODEL	LINE SIZE in	DRUM "D" in	BASE "B" in	HEIGHT "H" in	LINE ENTRY "L" in	MAX. DECK "K" in*1	MOTOR DEPTH "J" in	MOTOR WIDTH "N" in	WEIGHT lb
RA2052013100	52ST	5/16 - 5/8	3 15/16	7 7/8	8 11/16	4 3/16	2 1/8	9 11/16	5 1/8	50.7
RA2058013100	58ST	5/16 - 5/8	4 1/2	9 1/16	9 7/8	4 3/8	2 1/8	9 29/32	5 1/8	66.1
RA2062013100	62ST	5/16 - 5/8	4 1/2	9 1/16	9 7/8	4 3/8	2 1/8	9 29/32	5 1/8	66.1
RA2068013100	68ST	3/8 - 5/8	5 1/2	11	10 3/4	4 3/4	2 3/8	9 1/8	5 1/8	90.4
RA2072013100	72ST	3/8 - 5/8	5 1/2	11	10 3/4	4 3/4	2 3/8	9 1/8	5 1/8	90.4

*1 Extensions available to suit longer "K" dimensions.



© Spirit Yachts / Carlo Borlenghi

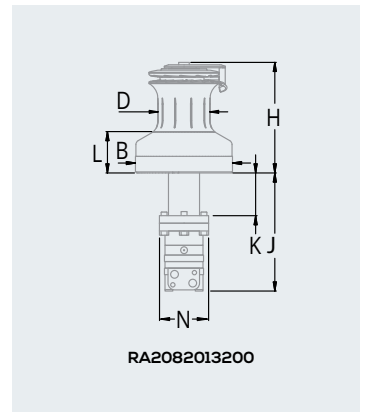

PRODUCT No.	WINCH MODEL	LINE SIZE mm	DRUM "D" mm	BASE "B" mm	HEIGHT "H" mm	LINE ENTRY "L" mm	MAX. DECK "K" mm*	MOTOR DEPTH "J" mm	MOTOR WIDTH "N" mm	WEIGHT kg
RA2082013200	82-3ST	12 - 18	170	318	305	127	145	350	132	43

METRIC DIMENSIONS

PRODUCT No.	WINCH MODEL	LINE SIZE in	DRUM "D" in	BASE "B" in	HEIGHT "H" in	LINE ENTRY "L" in	MAX. DECK "K" in*	MOTOR DEPTH "J" in	MOTOR WIDTH "N" in	WEIGHT lb
RA2082013200	82-3ST	1/2 - 3/4	6 11/16	12 1/2	12	5	5 23/32	13 25/32	5 3/16	94.8

IMPERIAL DIMENSIONS

* Extensions available to suit longer "K" dimensions.



© David Pichler / Robline

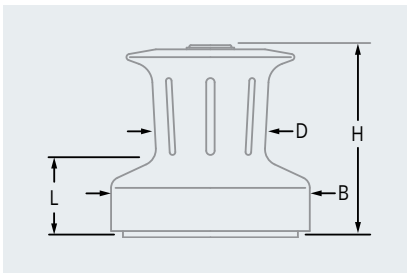

PRODUCT No.	WINCH MODEL	GEAR RATIO 1ST SPEED	GEAR RATIO 2ND SPEED	POWER RATIO 1ST SPEED	POWER RATIO 2ND SPEED	DRUM "D" mm	BASE "B" mm	HEIGHT "H" mm	LINE ENTRY "L" mm	WEIGHT kg
-------------	-------------	----------------------	----------------------	-----------------------	-----------------------	-------------	-------------	---------------	-------------------	-----------

METRIC DIMENSIONS

RA500010	10	1.0:1	-	8.8:1	-	57	92	89	28	1.1
RA500018	18	1.0:1	2.1:1	8.3:1	17.4:1	60	114	110	45	2.6
RA500028	28	1.0:1	4.0:1	7.1:1	28.6:1	70	124	126	53	3.3
RA500040	40	1.0:1	6.4:1	6.5:1	42.5:1	76	136	140	63	3.9
RA500046	46	1.0:1	6.4:1	6.4:1	45.6:1	78	143	140	63	4.0

PRODUCT No.	WINCH MODEL	GEAR RATIO 1ST SPEED	GEAR RATIO 2ND SPEED	POWER RATIO 1ST SPEED	POWER RATIO 2ND SPEED	DRUM "D" in	BASE "B" in	HEIGHT "H" in	LINE ENTRY "L" in	WEIGHT lb
-------------	-------------	----------------------	----------------------	-----------------------	-----------------------	-------------	-------------	---------------	-------------------	-----------

IMPERIAL DIMENSIONS

RA500010	10	1.0:1	-	8.8:1	-	2 1/4	3 5/8	3 1/2	1 3/32	2.4
RA500018	18	1.0:1	2.1:1	8.3:1	17.4:1	2 3/8	4 1/2	4 11/32	1 25/32	5.7
RA500028	28	1.0:1	4.0:1	7.1:1	28.6:1	2 3/4	4 7/8	4 31/32	2 3/32	7.3
RA500040	40	1.0:1	6.4:1	6.5:1	42.5:1	3	5 11/32	5 1/2	2 15/32	8.6
RA500046	46	1.0:1	6.4:1	6.4:1	45.6:1	3 1/16	5 5/8	5 1/2	2 15/32	8.8



- ✓ Andersen classic winches are used by the top match racing centres and fitted as standard equipment on a variety of classes that require simplicity combined with utmost dependability.
- ✓ Handles are included as shown.

PRODUCT No.	DESCRIPTION
Classic Winch Handles	
RA510901	Classic winch handle to suit Model 90
RA510911	Classic winch handle to suit Model 91
RA511001	Classic winch handle to suit Model 100
RA511011	Classic winch handle to suit Model 101
RA511021	Classic winch handle to suit Model 102

PRODUCT No.	WINCH MODEL	GEAR RATIO	POWER RATIO	DRUM "D" mm	BASE "B" mm	HEIGHT "H" mm	SHAFT LENGTH "J" mm	HANDLE CLEARANCE "S" mm	HANDLE CLEARANCE "R" mm	WEIGHT kg
RA510091	91	1.0:1	8.0:1	51	80	94	-	-	224	1.0
RA510101	101	1.0:1	5.5:1	83	111	89	-	-	275	1.5
RA510102	102	1.0:1	5.5:1	83	111	74	150	255	-	2.0
RA510103	102	1.0:1	5.5:1	83	111	74	200	255	-	2.1
RA510105	102	1.0:1	5.5:1	83	111	74	100	255	-	1.9

PRODUCT No.	WINCH MODEL	GEAR RATIO	POWER RATIO	DRUM "D" in	BASE "B" in	HEIGHT "H" in	SHAFT LENGTH "J" in	HANDLE CLEARANCE "S" in	HANDLE CLEARANCE "R" in	WEIGHT lb
RA510091	91	1.0:1	8.0:1	2	3 5/32	3 11/16	-	-	8 13/16	2.2
RA510101	101	1.0:1	5.5:1	3 9/32	4 3/8	3 1/2	-	-	10 3/16	3.3
RA510102	102	1.0:1	5.5:1	3 9/32	4 3/8	2 29/32	5 29/32	10	-	4.4
RA510103	102	1.0:1	5.5:1	3 9/32	4 3/8	2 29/32	7 7/8	10	-	4.6
RA510105	102	1.0:1	5.5:1	3 9/32	4 3/8	2 29/32	3 15/16	10	-	4.2

METRIC DIMENSIONS

IMPERIAL DIMENSIONS



Easy, single-handed
release button



Secure, auto-insert
locking mechanism

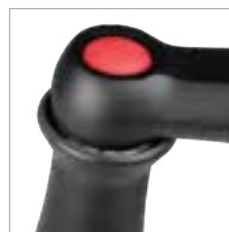

Ball bearing handle for
minimum friction

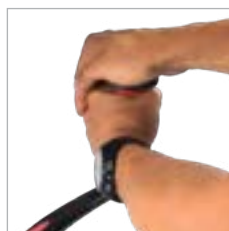
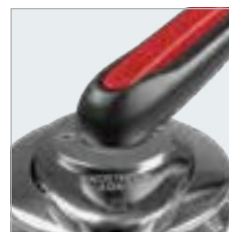

Palm grip models for
maximum speed and power

QUICK-LOCK™ HANDLES

POWER, PERFORMANCE & INTUITIVE OPERATION

The Ronstan Quick-Lock™ is the quickest and most user friendly winch handle available for racing and cruising sailors alike. In addition to its super fast grab-and-release mechanism for intuitive single handed removal, it is the only handle to feature the patented auto quick-locking mechanism that lets you put the handle in the winch without depressing a lever or rotating a knob – it couldn't be easier!

Quick-Lock™ automatic insertion

Ronstan Quick-Lock™ allows you to immediately place the drive head into the winch socket without the need to rotate a knob or depress a button. Its stainless steel locking lever then retains the handle securely in place until you are ready to remove it.

Intuitive grab & release

The large easy to locate release button extends up the length of the handle providing intuitive grab-and-release operation. This makes the Quick-Lock™ ideal for easy one-handed use by any crew.

Power in your hands

A precision ball bearing race in the hand grip provides free rotation for high speed or high power cranking, and the refined ergonomics ensure efficient transfer of effort. 8" (200mm) models cater to situations with restricted space and 10" (250mm) handles provide greater mechanical advantage - the basis on which winch power ratios are calculated. Palm grip handles are the ultimate option where fast two-handed cranking is required.



- ✔ Patented auto lock-in latch.
- ✔ Large grab-and-release button.
- ✔ Single handed insert and release operation .

- ✔ 8" (200mm) and 10" (250mm) models.
- ✔ Standard and palm grip models.
- ✔ Ball bearing hand grips.

- ✔ Lightweight forged construction.
- ✔ Corrosion resistant hard coat anodised finish.

PRODUCT No.	GRIP	LENGTH mm	WEIGHT g	LENGTH in	WEIGHT oz
Single Grip					
RF4410	Single	200	415	8	14.6
RF4415	Single	250	450	10	15.9
Palm Grip					
RF4430	Palm	200	470	8	16.6
RF4435	Palm	250	525	10	18.5



PLASTIC WINCH HANDLES

- ✔ Lightweight.
- ✔ Two-piece welded construction.
- ✔ Serviceable locking mechanism.
- ✔ Aluminium drive plug.

STAINLESS STEEL WINCH HANDLES

- ✔ Robust stainless steel construction.
- ✔ Stainless steel drive plug.

RF4099 WINCH HANDLE POCKET

- ✔ Screw holes and webbing/lashing slots for mounting.
- ✔ UV stabilised.
- ✔ Strong but flexible for maximum durability.

PRODUCT No.	DESCRIPTION	LENGTH mm	WEIGHT g	LENGTH mm	WEIGHT oz
Winch Handles					
RA507297	Stainless steel Andersen winch handle	200	400	8	14.1
RA507298	Stainless steel Andersen winch handle	250	450	10	15.9
RF4110	Plastic winch handle	200	270	8	9.5
RF4115	Plastic winch handle	250	320	10	11.3
RF4109	Locking mechanism service kit, suits plastic winch handles	-	-	-	-
Winch Handle Pockets					
RF3941	Winch handle pocket, grey PVC with mesh	-	230	-	8.1
RF4099	Winch handle pocket, PVC	-	308	-	10.9



SERVICE KITS

RA500001-1

✔ For optimum performance and long life of your Andersen winch, it should be serviced every 2 years or so under normal use. Service kits contain the basic replacement parts for your specific winch model service.

✔ See the SUPPORT section of the www.andersenwinches.com website for further information regarding installation, use and service of current and past models of Andersen winches, including Product Manuals, Service Tips, etc.

PRODUCT No.	WINCHES SUITED	DESCRIPTION
Service Kits		
RA700020	Line Tender	Replacement pawls & springs, circlips
RA700021	52ST (v3.0 2009/later)	Replacement pawls & springs, plain bearing, ball bearings, retaining ring, screws, washers
RA710001	12ST, 28ST (10.2005/earlier), 40ST	Replacement pawls & springs, ball bearings, circlips, screws, retaining ring, locking pin
RA710002	46ST (1982 - 1993)	Replacement pawls & springs, circlip, screws
RA710003	56ST, 66ST	Replacement pawls & springs, ball bearings, circlips, screws, washers, locking pin, sealing ring
RA710004	10, 18, 28, 40, 46 Classic	Replacement pawls & springs, circlips
RA710005	56 Classic	Replacement pawls & springs, ball bearings, circlips, locking pin
RA710007	78ST (10.2005/later)	Replacement pawls & springs, O-ring, ball bearings, circlips, screws, washers
RA710008	52ST (v2.5 2009/earlier)	Replacement pawls & springs, plain bearing, ball bearings, circlips, screws, retaining ring
RA710010	Springs for Andersen winches	Replacement pawl springs only: 10 x arm springs, 10 x spiral springs
RA710011	46ST (1993 - 1996)	Replacement pawls & springs, plain bearing, ball bearings, circlip, screws
RA710012	58ST, 62ST	Replacement pawls & springs, plain bearing, ball bearings, circlips, screws, retaining ring
RA710013	68ST, 72ST	Replacement pawls & springs, plain bearing, ball bearings, circlip, screws, retaining ring
RA710014	90, 91, 92 Classic	Replacement pawls & springs, circlip, screws, washers
RA710015	100, 101, 102 Classic	Replacement pawls & springs, circlip, screws, washers
RA710016	6 Classic	Replacement pawls & springs, screws, washers
RA710017	46ST (1997- v3.2 07.2006)	Replacement pawls & springs, plain bearing, ball bearings, circlips, screws
RA710018	12ST, 18ST, 28ST (11.2005/later), 34ST	Replacement pawls & springs, plain bearing, screws, locking pin
RA710019	46ST v.4.0 (08.2006/later), 48ST, 50ST	Replacement pawls & springs, plain bearing, circlip, screws
RA710040	82-3ST v1.0	Replacement pawls, auto-switch pawls, springs, slide plungers, disc springs
Winch Grease		
RA500001		Winch grease tube, 12-pack, including display carton
RA500001-1		Winch grease, single tube

501001	101,151	CS7803-05	234	PNP88A	169	PNP245BLK	175	RA554131	237
501002	96,148	DSH-2.5GRY	234	PNP88B	169	PNP246	175	RA554132	237
501003	109,154,157	DSH-4GRY	234	PNP88C	169	PNP246BLK	175	RA554133	237
501004	117,119,160,161	DSH-6GRY	234	PNP89	173	PNP255	172	RA554136	237
501005	125,127,164	DSH-9GRY	234	PNP94	180	PNP256	172	RA574150	237
501010	104	DSH-12GRY	234	PNP96	175	PNP257	172	RA574151	237
581001	95,146,148	DSH-14GRY	234	PNP97	175	PNP258	172	RA574152	237
581002	140	PNP1	171	PNP98JR	70	PNP259	172	RA574153	237
581004	142	PNP3	170	PNP98KR	70	PNP260	172	RA574154	237
601369	162	PNP5	170	PNP102	168	PNP261	172	RA582000	255,259
601372	141,143,151,152	PNP11	171	PNP103	168	PNP262	172	RA582010	255,259
601373	166	PNP13A	170	PNP104	168	PNP265	171	RA582020	255,259
601391	154,155,157,158	PNP13B	170	PNP105	169	PNP266	171	RA590070	255
601417	146,148,149	PNP14	169	PNP106	169	PNP272	168	RA590120	255
877750	263,265	PNP14A	169	PNP107	169	PNP272A	173	RA590150	255,259
CL16	195	PNP14B	169	PNP108	169	PNP272ABLU	173	RA590200	255,259
CL210	189	PNP16	170	PNP120	171	PNP272AGRN	173	RA700020	273
CL220	189	PNP16A	170	PNP120A	171	PNP272D	173	RA700021	273
CL240	189	PNP16B	170	PNP121	171	PNP272AR	173	RA710001	273
CL250	188	PNP17T	168	PNP121A	171	PNP273	168	RA710002	273
CL260	188	PNP18T	168	PNP122	171	PNP280	168	RA710003	273
CL270	187	PNP20	170	PNP122A	171	PNP280A	168	RA710004	273
CL600	194	PNP27T	168	PNP123	171	PNP290	168	RA710005	273
CL620	194	PNP28T	168	PNP123A	171	PNP291	168	RA710007	273
CL630	194	PNP29T	168	PNP124	171	PNP293	168	RA710008	273
CL640	194	PNP33	171	PNP124A	171	PNP295	168	RA710010	273
CL700	193	PNP33BLK	171	PNP131	174	PNP296	168	RA710011	273
CL710	193	PNP38	170	PNP132A	174	PNP297	168	RA710012	273
CL730	193	PNP39A	172	PNP132B	174	PNP298	168	RA710013	273
CL740	193	PNP39B	172	PNP132C	174	PNP301	177	RA710014	273
CL800	190	PNP43A	170	PNP132E	174	PNP310	174	RA710015	273
CL810	190	PNP43B	170	PNP147	169	PNP310G	174	RA710016	273
CS321-6	236	PNP43C	170	PNP148	169	PNP315	174	RA710017	273
CS321-8	236	PNP43D	170	PNP155	169	PNP387	170	RA710018	273
CS2430-6	235	PNP43E	170	PNP162	167,169	PNP388	170	RA710019	273
CS2430-8	235	PNP43F	170	PNP164	181	PNP389	170	RA710040	273
CS2430-10	235	PNP45	170	PNP165	181	PNP390	175	RA866000	263,265
CS2430-12	235	PNP47	168	PNP166	181	PNP393	175	RA866010	263,265
CS2450-5	235	PNP48	171	PNP171BLU	179	PNP393W	175	RA866020	263
CS2450-6	235	PNP49	171	PNP171R	179	PNP576-2	170	877800	263
CS2450-8	235	PNP52C	171	PNP181	172	PNP577-2	170	RA2012010000	251
CS2450-10	235	PNP53E	171	PNP182	172	PNP578-2	170	RA2018010000	251
CS2470-50	235	PNP54	172	PNP183	172	PNP579-2	170	RA2028010000	251
CS2470-70	235	PNP55	85	PNP186	172	RA435200	237	RA2028011300	255
CS2470-100	235	PNP56	170	PNP187	172	RA500001	273	RA2028011400	255
CS2482-1	236	PNP56B	170	PNP188	172	RA500001-1	273	RA2028014100	265
CS2482-2	236	PNP63	169	PNP189	172	RA500010	268	RA2028014200	265
CS2483-1	236	PNP64	169	PNP197GRN	180	RA500018	268	RA2028015100	263
CS2483-2	236	PNP65	169	PNP197R	180	RA500028	268	RA2028015200	263
CS2831-6	234	PNP68C	173	PNP198GRN	180	RA500040	268	RA2028211300	255
CS3182-555	236	PNP78	171	PNP198R	180	RA500046	268	RA2028211400	255
CS3182-860	236	PNP78A	171	PNP199R	180	RA507297	272	RA2028214100	265
CS7350-4	235	PNP78B	171	PNP200	180	RA507298	272	RA2028214200	265
CS7350-6	235	PNP78C	171	PNP207	173	RA510091	269	RA2028215100	263
CS7350-8	235	PNP81A	169	PNP209	182	RA510101	269	RA2028215200	263
CS7350-10	235	PNP81B	169	PNP241	175	RA510102	269	RA2034010000	251
CS7801-M03M6	234	PNP83	169	PNP242	175	RA510103	269	RA2034011300	255
CS7801-M04M6	234	PNP84	170	PNP243	175	RA510105	269	RA2034011400	255
CS7803-04M5	234	PNP87	169	PNP245	175	RA554130	237	RA2034014100	265

RA2034014200	265	RA2052214200	265	RA2072214100	265	RC00422	92	RC1260-3.0	106
RA2034015100	263	RA2052215100	263	RA2072214200	265	RC00423	93	RC1261-2.0	156
RA2034015200	263	RA2052215200	263	RA2072215100	263	RC00424	113	RC1261-3.0	156
RA2034211300	255	RA2058010000	251	RA2072215200	263	RC00451	97	RC1261J	106,156
RA2034211400	255	RA2058011300	255	RA2082010000	251	RC00452	97	RC1262-2.0	156
RA2034214100	265	RA2058011400	255	RA2082012200	259	RC00453	97	RC1262-3.0	156
RA2034214200	265	RA2058013100	266	RA2082013200	267	RC00461	102	RC1262J	156
RA2034215100	263	RA2058014100	265	RC00010	140,142,146,148,149,151	RC00462	102	RC1269-0.3	156
RA2034215200	263	RA2058014200	265	RC00011	152,154,155,157,158	RC00463	102	RC1269-0.3L	156
RA2040010000	251	RA2058015100	263	RC00012	152,154,155,157,158	RC00464	102	RC1300-1.0	114
RA2040011300	255	RA2058015200	263	RC00013	160	RC00465	102	RC1300-2.0	114
RA2040011400	255	RA2058211300	255	RC00014	164	RC00476	90	RC1300-3.0	114,245
RA2040014100	265	RA2058211400	255	RC00015	161	RC00477	90	RC1300-3.0S	245
RA2040014200	265	RA2058214100	265	RC00020	146,148,149	RC00478	90	RC1301-2.0	159
RA2040015100	263	RA2058214200	265	RC00021	141,143,151,152	RC00481	111	RC1301-3.0	159
RA2040015200	263	RA2058215100	263	RC00022	154,155,157,158	RC00483	111	RC1301J	114,159,245
RA2040211300	255	RA2058215200	263	RC00023	162	RC00485	111	RC1302-2.0	159
RA2040211400	255	RA2062010000	251	RC00024	166	RC00492	120	RC1302-3.0	159
RA2040214100	265	RA2062011300	255	RC00110	167	RC00493	120	RC1302J	159
RA2040214200	265	RA2062011400	255	RC00111	167	RC00495	120	RC1305B-3.0	114
RA2040215100	263	RA2062013100	266	RC00112	167	RC1140-1.0	95	RC1305BP	114
RA2040215200	263	RA2062014100	265	RC00140	167	RC1140-1.5	95	RC1309-0.4	159
RA2046010000	251	RA2062014200	265	RC00141	167	RC1140-2.0	95	RC1309-0.4L	159
RA2046011300	255	RA2062015100	263	RC00142	167	RC1140-3.0	95	RC1420-1.0	123,163
RA2046011400	255	RA2062015200	263	RC00143	167	RC1141-2.0	147	RC1420-2.0	123,163
RA2046014100	265	RA2062211300	255	RC00150	167	RC1141-3.0	147	RC1420-3.0	123,163
RA2046014200	265	RA2062211400	255	RC00151	167	RC1141J	95,147	RC1421J	123,163
RA2046015100	263	RA2062214100	265	RC00152	167	RC1149-0.2	147	RC1422-2.0	163
RA2046015200	263	RA2062214200	265	RC00153	167	RC1190-1.0	98	RC1422-3.0	163
RA2046211300	255	RA2062215100	263	RC00210	167	RC1190-1.5	98	RC1422J	163
RA2046211400	255	RA2062215200	263	RC00211	167	RC1190-2.0	98	RC1425-3.0	123
RA2046214100	265	RA2068010000	251	RC00212	167	RC1190-3.0	98	RC1425P	123
RA2046214200	265	RA2068011300	255	RC00213	167	RC1191-2.0	150	RC1429-0.6	163
RA2046215100	263	RA2068011400	255	RC00214	167	RC1191-3.0	150	RC1429-0.6L	163
RA2046215200	263	RA2068011800	256	RC00215	167	RC1191J	98,150	RC1550-1.0	128
RA2050010000	251	RA2068013100	266	RC00241	167	RC1192-2.0	150	RC1550-2.0	128
RA2050011300	255	RA2068014100	265	RC00251	167	RC1192-3.0	150	RC1550-3.0	128
RA2050011400	255	RA2068014200	265	RC00252	167	RC1192FP	150	RC1551J	128
RA2050014100	265	RA2068015100	263	RC00253	167	RC1192J	150	RC1552J	166
RA2050014200	265	RA2068015200	263	RC00310	144,150	RC1199-0.3	150	RC1552-2.0	166
RA2050015100	263	RA2068211300	255	RC00312	144,150	RC1199-0.3L	150	RC1552-3.0	166
RA2050015200	263	RA2068211400	255	RC00315	144,150	RC1220-1.0	103	RC1559-0.8L	166
RA2050211300	255	RA2068211800	256	RC00316	144,150	RC1220-2.0	103	RC6190-1.0	92
RA2050211400	255	RA2068214100	265	RC00321	144,150	RC1220-3.0	103,244	RC6190-1.5	92
RA2050214100	265	RA2068214200	265	RC00322	144,150	RC1220-3.0S	244	RC6190-2.0	92
RA2050214200	265	RA2068215100	263	RC00323	144,150	RC1221-2.0	153	RC6190-3.0	92
RA2050215100	263	RA2068215200	263	RC00332	144,153,156	RC1221-3.0	153	RC6320-1.0	93
RA2050215200	263	RA2072010000	251	RC00333	144,153,156	RC1221J	103,153,244	RC6320-1.5	93
RA2052010000	251	RA2072011300	255	RC00341	144,153,156	RC1222-2.0	153	RC6320-2.0	93
RA2052011300	255	RA2072011400	255	RC00343	144,153,156	RC1222-3.0	153	RC6320-3.0	93
RA2052011400	255	RA2072011800	256	RC00360	144,159	RC1222J	153	RC7250-INS	89,92
RA2052013100	266	RA2072013100	266	RC00370	144,150	RC1225-3.0	103	RC7251-0.5A	89
RA2052014100	265	RA2072014100	265	RC00380	144,153,156	RC1225P	103	RC7251-1.0A	89
RA2052014200	265	RA2072014200	265	RC00410	98	RC1225B-2.0	103	RC7251-1.5	89
RA2052015100	263	RA2072015100	263	RC00411	101,103	RC1225BP	103	RC7251-2.0	89
RA2052015200	263	RA2072015200	263	RC00412	99,101	RC1229-0.3	153	RC7251-3.0	89
RA2052211300	255	RA2072211300	255	RC00414	93	RC1229-0.3L	153	RC7320-1.0	90
RA2052211400	255	RA2072211400	255	RC00420	98	RC1260-1.0	106	RC7320-1.5	90
RA2052214100	265	RA2072211800	256	RC00421	103	RC1260-2.0	106	RC7320-2.0	90

RC7320-3.0	90	RC12281	103,153,244	RC14236A	119	RC26463	141	RC61920	92
RC7320-INS	90,93	RC12281P	103,244	RC14241A	120	RC26466	141	RC61945	92
RC9190-0.3	87	RC12281PS	244	RC14244	120	RC28160	142	RC61980	92
RC9190-0.45	87	RC12281S	244	RC14260	160	RC28161	142	RC61983	92
RC9190-1.5	87	RC12283	102	RC14261	161	RC28163	143	RC61985	92
RC9190-3.0	87	RC12284	103	RC14263	162	RC28166	143	RC63201	93
RC11401	95	RC12285	103	RC14269	162	RC28169	143	RC6320J	93
RC11402	95	RC12603	105	RC14272	162	RC28181	143	RC63214	93
RC11403	95	RC12605	104	RC14280	123,163	RC28460	142	RC63215	93
RC11405	95	RC12613	105	RC14281	123,163	RC28461	142	RC63216	93
RC11410	95	RC12617	104	RC14281A	122	RC28463	143	RC63217	93
RC11460	146	RC12623	105	RC14283	120	RC28466	143	RC63280	93
RC11463	146	RC12631	105	RC14284	122	RC28469	143	RC63283	93
RC11466	146	RC12660	154	RC14284A	122	RC41960	149	RC63285	93
RC11480	95,147	RC12663	154	RC14285	122	RC41961	149	RC72504	89
RC11481	147	RC12669	154	RC14285A	122	RC41963	149	RC72505	89
RC11902	96	RC12672	154	RC14285B	122	RC41966	149	RC72506	89
RC11903	96	RC12680	106,156	RC14287	122	RC41969	149	RC72533S	89
RC11905	96	RC12681	106,156	RC15505	124	RC41972	149	RC72536S	88
RC11910	96	RC12681P	106	RC15515	124	RC42260	152	RC72537S	88
RC11912	97	RC12683	106	RC15518A	125	RC42260L	152	RC72540S	88
RC11920	96	RC12685	106	RC15531	126	RC42263	152	RC72541	89
RC11921	96	RC12686	106	RC15531A	126	RC42263L	152	RC72544	89
RC11922	97	RC12687	106	RC15536	127	RC42266	152	RC72581	89
RC11930	97	RC12687C	106	RC15536A	127	RC42266L	152	RC73201	90
RC11945	96	RC13003	109	RC15541	127	RC42269	152	RC73202	90
RC11960	148	RC13004	109	RC15560	164	RC42269L	152	RC73231	90
RC11960D	148	RC13005	108	RC15561	165	RC42272	152	RC73234	90
RC11963	148	RC13012	109	RC15563	166	RC42272L	152	RC73235	90
RC11963D	148	RC13013	109	RC15569	166	RC42660	155	RC73243	90
RC11965	148	RC13017	108	RC15572	166	RC42663	155	RC73280	90
RC11966	148	RC13018A	108	RC15580	128	RC42669	155	RC91901	87
RC11966D	148	RC13023	109	RC15581	128,166	RC42672	155	RC91940	87
RC11969	148	RC13031	110	RC15581A	128	RC43060	158	RC91941	87
RC11972D	148	RC13033	110	RC15583	126	RC43061	158	RC91942	87
RC11980	98,150	RC13044	111	RC15584	128	RC43063	158	RC91944	87
RC11981	150	RC13046	111	RC15585	128	RC43069	158	RC91980	87
RC11981P	98	RC13060	157	RC15585A	128	RC43072	158	RCC22-4	245
RC11983	98	RC13063	157	RC20101	140,142	RC51930	97	RCC22-5	244
RC11984	98	RC13069	157	RC20102	140	RC51940	97	RCC30-1A	245
RC11985	98	RC13072	157	RC20111	140	RC52202	102	RCC30-1AB	245
RC12203	99	RC13080	114,159	RC20112	140	RC52203	102	RCC30-2A	245
RC12204	100	RC13081	113,159,245	RC20113	140	RC52230	101	RCC30-2AB	245
RC12205	99	RC13081P	113,245	RC20114	140	RC52240	102	RCC30-3A	245
RC12210	99	RC13081PS	245	RC20115	140	RC52241	102	RCC30-3AB	245
RC12213	100	RC13081S	245	RC20116	140	RC52243	102	RCC22-1A	244
RC12220	99	RC13083	113	RC20118	140	RC53003	111	RCC22-1AB	244
RC12221	99	RC13084	113	RC20119	140	RC53030	110	RCC22-2A	244
RC12223	100	RC13085	113	RC20130	142	RC53040	111	RCC22-2AB	244
RC12227	100	RC13086	113	RC20131	142	RC53047	112	RCC22-3A	244
RC12231	101	RC13087	113	RC20135	142	RC54230	118	RCC22-3AB	244
RC12244	102	RC14205	116	RC26160	140	RC54230A	118	RD738000	211
RC12245	102	RC14214	116	RC26163	141	RC54240A	120	RD877610	263,265
RC12260	151	RC14215	116	RC26166	141	RC54247	121	RD877611	263,265
RC12263	151	RC14215A	117	RC26181	141	RC61901	92	RF3	132
RC12266	151	RC14218A	117	RC26360	140	RC6190J	92	RF4	18,20,78
RC12269	151	RC14231A	118	RC26363	141	RC61910	92	RF5	78
RC12272	151	RC14231B	118	RC26366	141	RC61912	92	RF6	79
RC12280	103,153	RC14236	119	RC26460	140	RC61914	92	RF7	79

RF9	171,179	RF128	70	RF274	230	RF528	209	RF636	202
RF16	206	RF129	70	RF275	230	RF529	209	RF637	202
RF17	179	RF132	70	RF276	230	RF530	175	RF638	202
RF26	212	RF133	7,209	RF277	230	RF533	206	RF639	202
RF27	178,179	RF134	95,209	RF278	230	RF536	207	RF640	202
RF30	180	RF134A	209	RF280	12	RF537	230	RF641	202
RF39	178	RF135	178	RF285	13	RF538	230	RF650	206
RF39A	178	RF144	184	RF291	209	RF539	230	RF652	206
RF41	180	RF146	178	RF294	175	RF541	212	RF653	206
RF43A	178	RF148	209	RF307	168,178	RF543	212	RF661	6
RF44	209	RF149	184	RF308	173	RF544	212	RF662	6
RF45	178	RF150	203	RF318	208	RF547	212	RF663	6
RF47	178	RF151	203	RF319	208	RF548	212	RF664	6
RF48	206	RF152	203	RF321	208	RF549	212	RF666	6
RF48A	207	RF154	184	RF323	208	RF559	212	RF667	42
RF48B	179	RF155	184	RF324	108,116,208	RF560	42	RF677	181
RF49	207	RF156	212	RF324-1	100,208	RF567	12	RF681	12
RF50	207	RF157	212	RF324-2	105,109,208	RF568	43	RF686	230
RF51	207	RF159	212	RF324-3	208	RF569	43	RF687	230
RF58	78	RF160	212	RF328	208	RF571	12	RF688	230
RF59	171	RF161	212	RF341	13,179	RF572	12	RF707S	203
RF60	78	RF162	212	RF343	13	RF573	12	RF711	206
RF67	78	RF163	212	RF347	178	RF575	12	RF712	206
RF70	78	RF164	212	RF348	178	RF576	203	RF713	206
RF75	203	RF165	212	RF374	171	RF578	70	RF714	206
RF76	132	RF166	212	RF413	85,230	RF600	181	RF734	175
RF78	207	RF167	212	RF415	209	RF601	181	RF737	175
RF78A	207	RF168	212	RF416	209	RF602	180	RF806S	203
RF78B	132,207	RF169	212	RF417	13	RF604	178	RF807	203
RF79	207	RF170	212	RF418	42	RF613S	7,202	RF815	133,203
RF81	13	RF171	212	RF418C	42	RF614	203	RF816	203
RF82	13	RF173	203	RF424	212	RF615	203	RF917	43
RF83	13	RF180	178	RF430	70	RF615A	203	RF919	43
RF87	178,209	RF181	178	RF431*	70	RF616	202	RF1006	70
RF88	207	RF185	13	RF437	70	RF617	202	RF1020	70
RF89	207	RF186	13	RF443	12	RF617A	52,53	RF1032	203
RF91	180	RF187	13	RF444	178	RF617H	202,239	RF1033	203
RF92	180	RF188	13	RF453	43	RF618	202	RF1034	203
RF94	209	RF191	178	RF467	12	RF618A	56	RF1035	202
RF94A	209	RF192	178	RF468	42	RF618H	202,241	RF1045	178
RF96	209	RF239	85	RF469	12	RF618T	52,56	RF1046	178
RF98	182	RF243	85	RF469A	12	RF619	202	RF1047	178
RF99	182	RF254	85	RF470	12	RF620	202	RF1048	178
RF103	42	RF255	85	RF481	231	RF621	202	RF1050	95,96,207
RF104	42	RF259	230	RF482	231	RF622	202	RF1051	105,109,207
RF111	184	RF260	230	RF483	231	RF623	202	RF1052	95,96,207
RF112	178	RF261	230	RF484	231	RF624	202	RF1053	99,105,109,207
RF113	230	RF262	230	RF485	231	RF625	202	RF1054	209
RF114	230	RF263	230	RF486	231	RF626	202	RF1055	209
RF115X1/2	230	RF264	230	RF487	231	RF627	202	RF1056	209
RF115X5/8	230	RF265	230	RF488	178	RF628	202	RF1057	209
RF115X3/4	230	RF266	230	RF494	82	RF629	202	RF1058	209
RF115X1	230	RF267	230	RF498	209	RF630	202	RF1121	84
RF115X11/4	230	RF268	230	RF499	209	RF631	202	RF1127	84
RF120	203	RF269	230	RF520	82	RF632	202	RF1135-16	84
RF122	206	RF270	230	RF521	82	RF633	202	RF1135-20	84
RF123	206	RF271	230	RF522	82	RF633S	7	RF1136	84
RF124	206	RF272	230	RF523	82	RF634	202	RF1189	178
RF125	206	RF273	230	RF524	82	RF635	202	RF1246	132

RF1247	132	RF1500-1614	228	RF1507M1212	227	RF1519M0404	226	RF2420	184
RF1297	92	RF1500-1814	228	RF1507M1414	227	RF1519M0405	226	RF2421	184
RF1315R	173	RF1500-2016	228	RF1507M1616	227	RF1519M0504	226	RF2422	184
RF1315BLK	173	RF1501M2.503	228	RF1508-0404	228	RF1519M0505	226	RF2429-02	51,209
RF1315BLU	173	RF1501M0304	228	RF1508-0505	228	RF1519M0506	226	RF2429-06	209
RF1315GRN	173	RF1501M0405	228	RF1508-0606	228	RF1519M0606	226	RF2429-08	209
RF1316BLK	173	RF1501M0505	228	RF1509M0304	228	RF1519M0608	226	RF2429-10	122,128,209
RF1316BLU	173	RF1501M0506	228	RF1509M0405	182,228	RF1519M0708	226	RF2433-09	210
RF1316GRN	173	RF1501M0608	228	RF1509M0506	228	RF1519M0808	226	RF2433-10	210
RF1316R	173	RF1501M0708	228	RF1510-0404	216,220	RF1519M0810	226	RF2435-12B	210
RF1317BLK	173,179	RF1501M0808	228	RF1510-0504	216,220,225	RF1519M1010	226	RF2435-14	210
RF1317BLU	173,179	RF1501M0810	228	RF1510-0505	216,220,225	RF1519M1112	226	RF2435-16B	210
RF1317GRN	173,179	RF1501M1010	228	RF1510-0604	220,225	RF1519M1212	226	RF2435-20B	210
RF1317R	173,179	RF1501M1112	228	RF1510-0605	216,220,225	RF1519M1414	226	RF2436-06	210
RF1318BLK	173	RF1501M1212	228	RF1510-0606	216,220,225	RF1519M1616	226	RF2436-08	210
RF1318BLU	173	RF1501M1414	228	RF1510-0706	216,220,225	RF1664	181	RF2436-10	210
RF1318GRN	173	RF1501M1616	228	RF1510-0806	216,220,225	RF1664S48	181	RF2437-12	211
RF1318R	173	RF1502-0404	223,224	RF1510-0808	216,220,225	RF1664S56	181	RF2437-16	211
RF1320R	203	RF1502-0505	223,224	RF1510-0908	216,220,225	RF1665	181	RF2454	18,20,208
RF1322	205	RF1502-0606	223,224	RF1510-1008	216,220,225	RF1665S74	181	RF2454B	18,20,208
RF1387	82	RF1504-0404	222	RF1510-1010	220,225	RF1665S96	181	RF2455	33,208
RF1415-04	229	RF1504-0505	222	RF1510-1210	220,225	RF1666	181	RF2455B	33,208
RF1415-05	229	RF1504-0606	222	RF1510-1412	220,225	RF1667	181	RF2488	231
RF1415-06	229	RF1504-0808	222	RF1510-1614	220,225	RF1685-2	231	RF2490	231
RF1415-08	229	RF1505-05	229	RF1510-1814	220,225	RF1685-4	231	RF2492	231
RF1415-10	229	RF1505-06	229	RF1510-2016	220,225	RF1685-5	231	RF2494	231
RF1415-12	229	RF1505-08	229	RF1512M0304	214,218,225	RF1685-6	231	RF2602	193
RF1415-14	229	RF1505-10	229	RF1512M0404	214,218,225	RF1685-8	231	RF2632	185
RF1415-16	229	RF1505-12	229	RF1512M0405	214,218,225	RF1685-10	231	RF2665	207
RF1455	78	RF1506-0404	227	RF1512M0504	218,225	RF1685-12	231	RF3001	185
RF1473-05	214,216	RF1506-0504	227	RF1512M0505	214,218,225	RF1706	195	RF3002	185
RF1473-05H	214,216	RF1506-0505	227	RF1512M0506	214,218,225	RF1741	70	RF3004	185
RF1480-04	218,220,222,223	RF1506-0604	227	RF1512M0606	214,218,225	RF1743	70	RF3005	185
RF1480-05	218,220,222,223	RF1506-0605	227	RF1512M0608	214,218,225	RF1746	70	RF3005X5.0	185
RF1480-06	218,220,222,223	RF1506-0606	227	RF1512M0708	214,218,225	RF1751	70	RF3122	84
RF1480-08	218,220,222	RF1506-0706	227	RF1512M0808	214,218,225	RF1759	70	RF3124	84
RF1480-10	218,220	RF1506-0806	227	RF1512M0810	218,225	RF1765	70	RF3128	84
RF1480-12	218,220	RF1506-0808	227	RF1512M1010	218,225	RF1766	70	RF3128C	84
RF1480-14	218,220	RF1506-0908	227	RF1512M1112	218,225	RF1767	70	RF3129	84
RF1480-16	218,220	RF1506-1008	227	RF1512M1212	218,225	RF1806	202	RF3129C	84
RF1481-04	214,216	RF1506-1010	227	RF1512M1414	218,225	RF1850S	202	RF3130	84
RF1481-05	214,216	RF1506-1210	227	RF1512M1616	218,225	RF1851	7,202	RF3130C	84
RF1481-06	214,216	RF1506-1412	227	RF1518-0404	226	RF1852	202	RF3131	84
RF1481-08	214,216	RF1506-1614	227	RF1518-0504	226	RF1853	202	RF3132	84
RF1484-04	224	RF1506-1814	227	RF1518-0505	226	RF2180	231	RF3133	84
RF1484-05	224	RF1506-2016	227	RF1518-0604	226	RF2181	231	RF3134	84
RF1484-06	224	RF1507M0304	227	RF1518-0605	226	RF2182	231	RF3135	84
RF1500-0303	228	RF1507M0404	182,227	RF1518-0606	226	RF2183	231	RF3135C	84
RF1500-0404	228	RF1507M0405	227	RF1518-0706	226	RF2184	231	RF3136	84
RF1500-0505	228	RF1507M0504	227	RF1518-0806	226	RF2330	178	RF3137	84
RF1500-0605	228	RF1507M0505	227	RF1518-0808	226	RF2331	178	RF3137C	84
RF1500-0606	228	RF1507M0506	227	RF1518-0908	226	RF2332	12	RF3169	231
RF1500-0706	228	RF1507M0606	227	RF1518-1008	226	RF2335	13	RF3170	231
RF1500-0808	228	RF1507M0608	227	RF1518-1010	226	RF2355	206	RF3171	231
RF1500-0908	228	RF1507M0708	227	RF1518-1210	226	RF2358	171	RF3172	231
RF1500-1008	228	RF1507M0808	227	RF1518-1412	226	RF2379	43	RF3173	231
RF1500-1010	228	RF1507M0810	227	RF1518-1614	226	RF2415	184	RF3174	231
RF1500-1210	228	RF1507M1010	227	RF1518-1814	226	RF2416	43,184	RF3175	231
RF1500-1412	228	RF1507M1112	227	RF1518-2016	226	RF2419	184	RF3910	183

RF3911	183	RF5400R	75	RF7010-13	69	RF20180	11	RF40140	23
RF3912	183	RF5400Y	75	RF7014-16	69	RF20184	11	RF40171	23,43
RF3941	183,272	RF5402	75	RF7110	205	RF20202	10	RF40200	22
RF3951	183	RF5404	75	RF7120	205	RF20212	10	RF40210	22
RF4002	195	RF5405	95	RF7210	205	RF20281	10	RF40300	22
RF4012	197	RF5410	76	RF7220	205	RF20284	10	RF40310	22
RF4013	197	RF5410B	76	RF7310	205	RF20302	10	RF40500	23
RF4014	197	RF5410G	76	RF7320	205	RF20312	10	RF40510	23
RF4015	196	RF5410R	76	RF8080BLU	45	RF20332	10	RF40520	23
RF4020	195	RF5410Y	76	RF8080GRY	45	RF20711	11,42	RF40530	23
RF4025	195	RF5412	76	RF8080R	45	RF20711A	11,42	RF41000	70
RF4026	195	RF5413A	76	RF8081BLU	45	RF20711AHL	11,42	RF41010	22
RF4050	199	RF5414	76	RF8081R	45	RF20711HL	11,42	RF41100	24
RF4054	201	RF5415	76	RF8090-05	46	RF21107	9	RF41101	24
RF4054A	201	RF5416	76	RF8090-08	46	RF25109	9	RF41110	24
RF4054B	201	RF5420	77	RF8090-11	46	RF25109HL	9	RF41111	24
RF4055	200	RF5420B	77	RF8090-16	46	RF30000HL	70	RF41140	24
RF4055A	200	RF5420G	77	RF8090-21	46	RF30100	16	RF41151	25
RF4055B	200	RF5420R	77	RF8090-26	46	RF30100HL	16	RF41153	25
RF4056	199	RF5420Y	77	RF8091-12	47	RF30101	16	RF41171	25,43
RF4099	272	RF5510R	76	RF8091-16	47	RF30101HL	16	RF41200	24
RF4109	272	RF5517	76	RF8092-12	47	RF30110	16	RF41210	24
RF4110	272	RF6010C	170	RF8093-12	47	RF30111	16	RF41300	24
RF4115	272	RF6031	178	RF9003-07	9,234	RF30141	16	RF41310	24
RF4410	271	RF6032	178	RF9004-08	234	RF30171	16,43	RF41500	25
RF4415	271	RF6033	178	RF9004-09	234	RF30174	16,43	RF41510	25
RF4430	271	RF6080	204	RF9004-11	234	RF30285	16	RF41520	25
RF4435	271	RF6100	204	RF9004-13	89,234	RF30711	16,42	RF41530	25
RF4714	209	RF6110	204	RF9005-10	234	RF30711HL	16,42	RF41712	42
RF5000	75	RF6111	205	RF9006-12	234	RF30721	16,42	RF41811	25
RF5001	75	RF6120	204	RF13101	6	RF31712	42	RF41821	41
RF5003	75,209	RF6130	204	RF13101G	6	RF34000	16,70	RF41831	41
RF5005	75	RF6160	204	RF13101R	6	RF34108	16	RF41841	41
RF5010	76	RF6161	204	RF15000	7,70	RF35000	15,70	RF44000	23,70,100,103,106
RF5011	76	RF6170	23,25,26,29,51,133,204	RF15100	7	RF35100	14	RF44100	51
RF5013	76,209	RF6200	204	RF15101	7	RF35100A	15	RF44108	23
RF5013A	76	RF6210	204	RF15111	7	RF35100D	14	RF44140	51
RF5015	76	RF6220	204	RF15141	7	RF35101	14	RF44188	51
RF5017	76	RF6230	204	RF15151	7	RF35101D	14	RF45101	18
RF5020	77	RF6260	204	RF15151A	7	RF35109HL	14	RF45110	18
RF5023	209	RF6262	204	RF15171	7,43	RF35140	15	RF45111	18
RF5100	73	RF6300	204	RF15174	7,43	RF35141	15	RF45130	18
RF5101	73	RF6310	204	RF15180	7	RF35151	15	RF45140	18
RF5105	73	RF6320	204	RF15202	7	RF35202	14	RF45151	19
RF5106	73	RF6321	205	RF15212	7	RF35212	14	RF45201	18
RF5110	73	RF6360	204	RF15302	7	RF35284	15	RF45501	19
RF5121	73,179	RF6361	204	RF15312	7	RF35286	15	RF45511	19
RF5122R-2	179	RF6411	205	RF15711	7,42	RF35302	14	RF45521	19
RF5270	212	RF6461	204	RF20000HL	11,70	RF35312	14	RF45531	19
RF5271	212	RF6511	205	RF20100	10	RF35322	15	RF46100	20
RF5272	212	RF6561	204	RF20101	10	RF35332	15	RF46100M	20
RF5280	212	RF6710	67	RF20101HL	10	RF40000HL	70	RF46101	20
RF5290	212	RF6711	67	RF20111	10	RF40001	20	RF46102	20
RF5292-M6	212	RF6720	67	RF20141	10	RF40002	20	RF46151	20
RF5292-M8	212	RF6721	67	RF20151	11,95	RF40100	22	RF46151A	20
RF5310	230	RF6730	67	RF20151A	11,95	RF40100HL	22	RF47109	69
RF5400	75,95	RF6741	67	RF20171	11,43	RF40101	22	RF50000HL	70
RF5400B	75	RF6751	67	RF20174	11,43	RF40110	22	RF50001	33
RF5400G	75	RF7008-09	69	RF20175	11,78	RF40111	22	RF50002	33

RF50003	33	RF62100	37	RF74251	56	RFSPLICE-1	133	RZ1700	240
RF50100	26	RF62174	37	RF77109	69	RFVANE-H	176	RZ1700AW	240
RF50100HL	26	RF62175	37	RF78000	71	RFVANE-K	176	RZ1703	240
RF50101	26	RF64100	52	RF78000W	104,108,110	RFVANE-O	176	RZ1705	240
RF50110	26	RF64100AW	52	RF78171	66	RFVANE-S	176	RZ1706	240
RF50171	26,43	RF64103	52	RF78174	66	RS000001	133	RZ1707	241
RF50200	26	RF64108	52	RF79000	57	RS006000A	133	RZ1708	240
RF50500	26	RF64108A	53	RF79100	57	RS006010A	133	RZ1709	240
RF50530	26	RF64108AW	52	RF79108	57	RS020050	138	RZ1710	241
RF51010	26	RF64110	52	RF79109	57	RS020050R	138	WR677-03M	232
RF51100	28	RF64130	52	RF79109A	57	RS208000	136	WR677-03MP	232
RF51101	28	RF64140	53	RF79110	57	RS208010	136	WR677-04M	232
RF51110	28	RF64151	53	RF79140	57	RS208015	138	WR6119-1.5M	232
RF51111	28	RF64202	52	RF79151	57	RS208020	138	WR6119-02M	232
RF51140	29	RF64251	53	RF79200	57	RS208030	138	WR6119-2.5M	232
RF51151	29	RF64500	53	RF79209	57	RS208040	138	WR6119-03M	232
RF51171	29,43	RF64503	53	RF104100	59	RS208050	138	WR6119-04M	232
RF51200	28	RF64520	53	RF104108A	59	RS208080	138	WR6119-05M	232
RF51210	28	RF64523	53	RF104110	59	RS208100	136	WR6119-06M	232
RF51300	28	RF66100	28	RF104140	59	RS212000	136	WR6119-07M	232
RF51500	29	RF67109	69	RF104151	59	RS212010	136	WR6119-08M	232
RF51510	29	RF68000	71	RF104200	59	RS212015	138	WR6119-10M	232
RF51530	29	RF68000W	71,101,105	RF108000	71	RS212020	138	WR6119-12M	232
RF51712	42	RF68171	66	RF108000W	71	RS212030	138	WR6119-14M	232
RF54000	104,108,110,113,116,122	RF68174	66	RF108171	66	RS212040	138	WR6119-16M	232
RF55101	31	RF69000	55	RF109000	60	RS212050	138	WR6719-1.5M	232
RF55110	30	RF69100	55	RF109100	60	RS212070	138	WR6719-02M	232
RF55111	31	RF69108	55	RF109100A	61	RS212080	138	WR6719-2.5M	232
RF55151	31	RF69109	55	RF109106A	61	RS212090	138	WR6719-03M	232
RF55171	31,43	RF69109A	55	RF109108	60	RS212100	136	WR6719-04M	232
RF55201	31	RF69110	55	RF109109	60	RS216000	136	WR6719-05M	232
RF55210	30	RF69140	55	RF109109A	61	RS216010	136	WR6719-06M	232
RF55301	31	RF69151	55	RF109110	60	RS216015	138	WR6719-07M	232
RF55310	30	RF69200	55	RF109110A	61	RS216020	138	WR6719-08M	232
RF55410	30	RF69209	55	RF109140	60	RS216030	138	WR6719-10M	232
RF55501	32	RF70000	70	RF109151	60	RS216040	138	WR6719-12M	232
RF55510	33	RF70300	40	RF109200	60	RS216050	138	WR6719-14M	232
RF55511	32	RF71000	71	RF109209	60	RS216070	138	WR6719-16M	232
RF55521	32	RF71171	66	RF128000	71	RS216080	138	WX10C	177
RF55530	33	RF72000	39,70	RF128000W	71	RS216090	138	WX15	177
RF55531	32	RF72100	39	RF128171	66	RS216100	136	WX15-BIRD	177
RF56100	34	RF72174	39	RF129100A	62	RS220000	137	WX23	177
RF56101	34	RF72175	39	RF129106A	62	RS220010	137	WXD	177
RF56110	34	RF72330	40	RF129109A	62	RS220015	138	WXD6	177
RF56120	35	RF72700	40	RF129110A	62	RS220030	138	WXLED	177
RF56130	35	RF72700B	40	RF129151A	62	RS220040	138		
RF56151	36	RF72700T	40	RF158000	71	RS220060	137		
RF56151A	36	RF72900	40	RF158000W	71	RS228000	137		
RF56330B	36	RF72900B	40	RF158171	66	RS228010	137		
RF56510	36	RF72900T	40	RF159100A	63	RS228015	138		
RF56530	36	RF74100	56	RF159106A	63	RS228030	138		
RF60000	70	RF74100AW	56	RF159109A	63	RS228040	138		
RF61000	71	RF74108	56	RF159110A	63	RS228060	137		
RF61171	66	RF74108A	56	RF159151	63	RZ1000	70,241		
RF61176	66	RF74110	56	RF189109A	64	RZ1000AW	70,241		
RF61821	41	RF74140	56	RF189151	64	RZ1600	239		
RF61831	41	RF74142	109	RF189251	64	RZ1603	239		
RF61841	41	RF74151	56	RF209109A	65	RZ1607	239		
RF62000	37,70	RF74202	56	RFC2433-09	246	RZ1611	239		

DEFINITIONS

Maximum Working Load (M.W.L.)

Maximum Working Load (M.W.L.) is the maximum static and/or dynamic load at which the product will still function without excessive friction, distortion, wear or permanent deformation of components. Above this load, bearing systems may fail, moving parts may seize and stainless steel or plastic components may begin to bend, stretch or otherwise deform. Maximum working loads should never exceed half of the breaking load and should never be exceeded in use.

Breaking Load (B.L.)

Breaking Load (B.L.) is the load at, or around which, a major failure can be expected to occur to some part of the product's structure when new. Plastic components may split, rivets may give way, shackles may break, and other metallic components may fracture. No product should be used at more than half of the breaking load so as to provide a minimum safety factor of two (2).

CUSTOMER CONSIDERATIONS

Product Information Amendments

All catalogue information is subject to specification changes during a product's life cycle. Any alterations will be posted on the website www.ronstan.com, which should be considered the most up to date source of product information.

Factor of Safety

An appropriate factor of safety should be applied to Breaking Load figures to suit each application before choosing or specifying a particular product. For many industrial and safety related applications, and for some yachting applications, a factor of safety greater than two (2) should be used or may be required by law or other regulations. It is the customer's responsibility to ensure that an appropriate factor of safety is used, and it should allow for factors including but not limited to safety implications, service life, fatigue (as may be caused by wave action, wind stresses or repetitive cyclical loading), type of load (e.g. cyclic, shock, rotational speed), orientation of load, environment (e.g. exposure to ultraviolet light, temperature extremes), corrosion and stress corrosion. Note that a 'safe working load' is not specified as this is dependent on the factor of safety, which must be determined by the user relative to each application.

Useful Life

The useful life of any product is determined by the above factors and must be assessed in each application, and thus no guarantee can be provided for product life, load capacity or any other factor due to the variability in usage. In some jurisdictions government regulations require the replacement of rigging components within certain periods of time, usually every three to five years. You must ascertain whether any such regulations affect you. Whilst Ronstan takes every precaution in their product design and manufacturing processes to minimise the effects of corrosion and stress corrosion, there are also preventative as well as corrective treatments that can be carried out after installation.

Warranty

Details of Ronstan's Product Warranty can be found under the SUPPORT tab at www.ronstan.com.

Distributors

Ronstan products are available through a great distribution network that extends to more countries than we can list on this page. Contact details for your nearest distributor can be found at www.ronstan.com.

TRADEMARKS

Trademark Acknowledgements

- Clamcleat® is a registered trademark of Clamcleats Limited
- Constrictor® is a registered trademark of Cousin Trestec
- Dyneema® is a registered trademark of DSM IP Assets B.V.
- Nylatron® is a registered trademark of Mitsubishi Chemical Advanced Materials Inc.
- Technora® is a registered trademark of Teijin Techno Products Limited Corporation
- Torlon® is a registered trademark of Solvay Advanced Polymers
- Windex® is a registered trademark of Windex Development AB

Registered Ronstan Trademarks

- Ronstan® is a registered trademark of Ronstan International Pty Ltd
- Andersen Stainless Steel Winches® is a registered trademark of Ronstan Denmark ApS

Ronstan Trademarks

- Andersen Winches™ (winches)
- Ballslide™ (batten cars)
- Battlestick™ (tiller extensions)
- BoatSmart™ (boat care products)
- Captive Lock™ (utility blocks)
- C-Cleat™ (cam cleats)
- ClearStart™ (sailing timer and watches)
- Compact Motor™ (electric winches)
- Core Block™ (blocks)
- Orbit Block™ (blocks)
- Power Rib™ (winches)
- Quick-Lock™ (winch handles)
- RopeGlide™ (Shocks™, rings, fairleads)
- Sailfast™ (silicon spray)
- Shock™ (sheaveless block)
- Skiffsuit™ (wetsuit)
- T-Cleat™ (cam cleats)
- Triggersnaps™ (trigger snap shackles)
- Ultimate Ratchet Block™ (ratchet blocks)
- V-Cleat™ (rope cleats)

BLOCKS	
CLEATS & CLUTCHES	
RUDDER & TILLER	
TRACK & TRAVELLER SYSTEMS	
FURLERS	
BATTEN CAR SYSTEMS	
MISCELLANEOUS HARDWARE & ACCESSORIES	
SAILING GEAR & ACCESSORIES	
STAINLESS STEEL HARDWARE	
RIGGING HARDWARE	
INDUSTRIAL PRODUCTS	
ANDERSEN STAINLESS STEEL WINCHES®	
INDEX & INFORMATION	

BLOCKS

CLEATS &
CLUTCHES

RUDDER &
TILLER

TRACK &
TRAVELLER
SYSTEMS

FURLERS

BATTEN CAR
SYSTEMS

MISCELLANEOUS
HARDWARE &
ACCESSORIES

SAILING GEAR &
ACCESSORIES

STAINLESS STEEL
HARDWARE

RIGGING
HARDWARE

INDUSTRIAL
PRODUCTS

ANDERSEN
STAINLESS STEEL
WINCHES®

INDEX &
INFORMATION



RONSTAN

www.ronstan.com
www.andersenwinches.com

HEAD OFFICE
AUSTRALIA

Ronstan International Pty. Ltd.
19 Park Way, Braeside
Victoria 3195, Australia
T +61 (0)3 8586 2000
E office@ronstan.com.au

DENMARK

Ronstan Denmark ApS
Jægervænget 36
7100 Vejle, Denmark
T +45 76 42 77 77
E office@ronstan.dk

USA

Ronstan International Inc.
1170 East Main Road, Unit 3
Portsmouth, RI 02871, USA
T +1 (401) 293 0539
E office@ronstan.us